

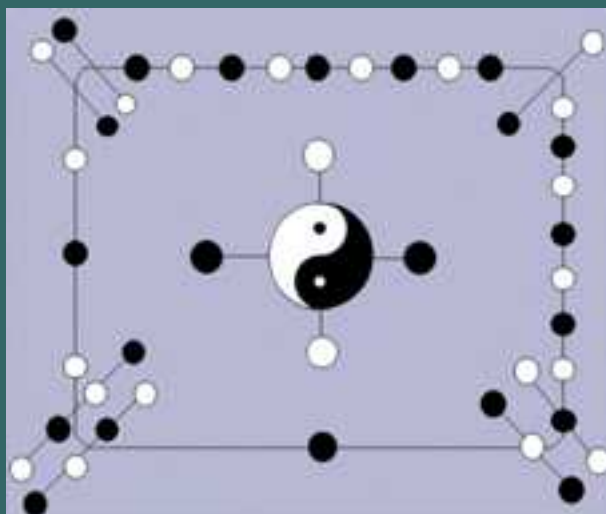

ISSN 1937 - 1055

VOLUME 4, 2016

INTERNATIONAL JOURNAL OF  
MATHEMATICAL COMBINATORICS



EDITED BY

THE MADIS OF CHINESE ACADEMY OF SCIENCES AND  
ACADEMY OF MATHEMATICAL COMBINATORICS & APPLICATIONS, USA

DECEMBER, 2016

Vol.4, 2016

ISSN 1937-1055

International Journal of  
**Mathematical Combinatorics**

Edited By

The Madis of Chinese Academy of Sciences and  
Academy of Mathematical Combinatorics & Applications, USA

December, 2016

**Aims and Scope:** The **International J.Mathematical Combinatorics** (*ISSN 1937-1055*) is a fully refereed international journal, sponsored by the *MADIS of Chinese Academy of Sciences* and published in USA quarterly comprising 110-160 pages approx. per volume, which publishes original research papers and survey articles in all aspects of Smarandache multi-spaces, Smarandache geometries, mathematical combinatorics, non-euclidean geometry and topology and their applications to other sciences. Topics in detail to be covered are:

Smarandache multi-spaces with applications to other sciences, such as those of algebraic multi-systems, multi-metric spaces, ···, etc.. Smarandache geometries;

Topological graphs; Algebraic graphs; Random graphs; Combinatorial maps; Graph and map enumeration; Combinatorial designs; Combinatorial enumeration;

Differential Geometry; Geometry on manifolds; Low Dimensional Topology; Differential Topology; Topology of Manifolds; Geometrical aspects of Mathematical Physics and Relations with Manifold Topology;

Applications of Smarandache multi-spaces to theoretical physics; Applications of Combinatorics to mathematics and theoretical physics; Mathematical theory on gravitational fields; Mathematical theory on parallel universes; Other applications of Smarandache multi-space and combinatorics.

Generally, papers on mathematics with its applications not including in above topics are also welcome.

It is also available from the below international databases:

Serials Group/Editorial Department of EBSCO Publishing

10 Estes St. Ipswich, MA 01938-2106, USA

Tel.: (978) 356-6500, Ext. 2262 Fax: (978) 356-9371

<http://www.ebsco.com/home/printsubs/priceproj.asp>

and

*Gale Directory of Publications and Broadcast Media*, Gale, a part of Cengage Learning

27500 Drake Rd. Farmington Hills, MI 48331-3535, USA

Tel.: (248) 699-4253, ext. 1326; 1-800-347-GALE Fax: (248) 699-8075

<http://www.gale.com>

**Indexing and Reviews:** Mathematical Reviews (USA), Zentralblatt Math (Germany), Referativnyi Zhurnal (Russia), Matematika (Russia), Directory of Open Access (DoAJ), International Statistical Institute (ISI), International Scientific Indexing (ISI, impact factor 1.659), Institute for Scientific Information (PA, USA), Library of Congress Subject Headings (USA).

**Subscription** A subscription can be ordered by an email directly to

**Linfan Mao**

The Editor-in-Chief of *International Journal of Mathematical Combinatorics*

Chinese Academy of Mathematics and System Science

Beijing, 100190, P.R.China

Email: [maolinfan@163.com](mailto:maolinfan@163.com)

**Price:** US\$48.00

## Editorial Board (4th)

### Editor-in-Chief

#### **Linfan MAO**

Chinese Academy of Mathematics and System  
Science, P.R.China

and

Academy of Mathematical Combinatorics &  
Applications, USA

Email: maolinfan@163.com

#### **Shaofei Du**

Capital Normal University, P.R.China

Email: dushf@mail.cnu.edu.cn

#### **Xiaodong Hu**

Chinese Academy of Mathematics and System  
Science, P.R.China

Email: xdhu@amss.ac.cn

### Deputy Editor-in-Chief

#### **Guohua Song**

Beijing University of Civil Engineering and  
Architecture, P.R.China

Email: songguohua@bucea.edu.cn

#### **Yuanqiu Huang**

Hunan Normal University, P.R.China

Email: hyqq@public.cs.hn.cn

#### **H.Iseri**

Mansfield University, USA

Email: hiseri@mnsfld.edu

### Editors

#### **Arindam Bhattacharyya**

Jadavpur University, India

Email: bhattachar1968@yahoo.co.in

#### **Xueliang Li**

Nankai University, P.R.China

Email: lxl@nankai.edu.cn

#### **Guodong Liu**

Huizhou University

Email: lgd@hzu.edu.cn

#### **Said Broumi**

Hassan II University Mohammedia

Hay El Baraka Ben M'sik Casablanca

B.P.7951 Morocco

#### **W.B.Vasantha Kandasamy**

Indian Institute of Technology, India

Email: vasantha@iitm.ac.in

#### **Junliang Cai**

Beijing Normal University, P.R.China

Email: caijunliang@bnu.edu.cn

#### **Ion Patrascu**

Fratii Buzesti National College

Craiova Romania

#### **Yanxun Chang**

Beijing Jiaotong University, P.R.China

Email: yxchang@center.njtu.edu.cn

#### **Han Ren**

East China Normal University, P.R.China

Email: hren@math.ecnu.edu.cn

#### **Jingan Cui**

Beijing University of Civil Engineering and  
Architecture, P.R.China

Email: cuijingan@bucea.edu.cn

#### **Ovidiu-Ilie Sandru**

Politehnica University of Bucharest  
Romania

**Mingyao Xu**

Peking University, P.R.China

Email: xumy@math.pku.edu.cn

**Guiying Yan**

Chinese Academy of Mathematics and System

Science, P.R.China

Email: yanguiying@yahoo.com

**Y. Zhang**

Department of Computer Science

Georgia State University, Atlanta, USA

**Famous Words:**

*The tragedy of the world is that those who are imaginative have but slight experience, and those who are experienced have feeble imaginations.*

By Alfred North Whitehead, a British philosopher and mathematician.

## Isotropic Smarandache Curves in Complex Space $C^3$

Süha Yılmaz

(Dokuz Eylül University, Buca Educational Faculty, 35150, Buca-Izmir, Turkey)

E-mail: suha.yilmaz@deu.edu.tr

**Abstract:** A regular curve in complex space, whose position vector is composed by Cartan frame vectors on another regular curve, is called a isotropic Smarandache curve. In this paper, I examine isotropic Smarandache curve according to Cartan frame in Complex 3-space and give some differential geometric properties of Smarandache curves. We define type-1  $e_1e_3$ -isotropic Smarandache curves, type-2  $e_1e_3$ -isotropic Smarandache curves and  $e_1e_2e_3$ -isotropic Smarandache curves in Complex space  $C^3$ .

**Key Words:** Complex space  $C^3$ , isotropic Smarandache curves, isotropic cubic.

**AMS(2010):** 53A05, 53B25, 53B30.

### §1. Introduction

It is observe that the imaginary curve in complex space were pioneered by E. Cartan. Cartan defined his moving frame and his special equations in  $C^3$ . In [6], the Cartan equations of isotropic curve is extended to space  $C^4$ . Moreover U. Pekmen [2] wrote some characterizations of minimal curves by means of E. Cartan equations in  $C^3$ .

A regular curve in Euclidean 3-space, whose position vector is composed by Frenet frame vectors on another regular curve, is called Smarandache curve. M. Turgut and S. Yılmaz have defined a special case of such curves and call it Smarandache  $TB_2$  curves in the space  $E_1^4$  [7]. A.T. Ali has introduced some special Smarandache curves in the Euclidean space [9]. Moreover, special Smarandache curves have been investigated by using Bishop frame in Euclidean space [10]. Special Smarandache curves according to Sabban frame have been studied by [11]. Besides some special Smarandache curves have been obtained in  $E_1^3$  by [12]. Apart from M. Turgut defined Smarandache breadth curves [8].

It is given that complex elements and complex curves to real space  $\mathbb{R}^3$  which are mentioned by Ferruh Semin, see [1]. In complex space  $C^3$  helices are characterized in [5]. In complex space  $C^4$ , S. Yılmaz characterized the isotropic curves with constant pseudo curvature which is called the slant isotropic helix. Yılmaz and Turgut give some characterization of isotropic helices in  $C^3$  [3].

Several authors introduce different types of helices and investigated their properties. For instance, Barros et. al. studied general helices in 3- dimensional Lorentzian space. Izumiya and

---

<sup>1</sup>Received January 6, 2016, Accepted November 2, 2016.

Takeuchi defined slant helices by the property that principal normal makes a constant angle with a fixed direction [14]. Kula and Yayli studied spherical images of tangent and binormal indicatrices of slant helices and they have shown that spherical images are spherical helix [15]. Ali and Lopez gave some characterization of slant helices in Minkowski 3-space  $E_1^3$  [13].

In this work, using not common vector field know as Cartan frame, I introduce a new Smarandache curves in  $C^3$ . Also, Cartan apparatus of Smarandache curves have been formed by Cartan apparatus of given curve  $\alpha = \alpha(s)$ .

## §2. Preliminaries

Let  $x_p$  be a complex analytic function of a complex variable  $t$ . Then the vector function

$$\vec{x}(t) = \sum_{p=1}^4 x_p(t) \vec{k}_p,$$

is called an imaginary curve, where  $\vec{x} : C \rightarrow C^4$ ,  $\vec{k}_p$  are standard basis unit vectors of  $E^3$  [6].

An isotropic curve  $x = x(s)$  in  $C^3$  is called an isotropic cubic if pseudo curvature of  $x(s)$  is congruent to zero. A direction  $(b_1, b_2, b_3)$  is a minimal direction if and only if

$$\sum_{p=1}^3 b_p^2 = 0.$$

A vector which has a minimal direction is called an isotropic vector or minimal vector. A vector  $\vec{v}$  is a minimal vector if and only if  $\vec{v}^2 = 0$ . Common points of a complex plane and absolute are called *siklik* points of the plane. A plane which is tangent to the absolute is called a minimal plane, see [6]. The curves, of which the square of the distance between the two points equal to zero, are called minimal or isotropic curves [3]. Let  $s$  denote pseudo arc-length A curve is an minimal (isotropic) curve if and only if ([4,5])

$$[\vec{x}'(t)]^2 = 0 \tag{2.2}$$

where  $\frac{d\vec{x}}{dt} = \vec{x}'(t) \neq 0$ . Let be each point  $\vec{x}$  of the isotropic curve. E. Cartan frame is defined (for well-known complex number  $i^2 = -1$ ) as follows, (see [1,4])

$$\begin{aligned} \vec{e}_1 &= \vec{x}' \\ \vec{e}_2 &= i \vec{x}'' \\ \vec{e}_3 &= -\frac{\beta}{2} \vec{x}' + \vec{x}''' \end{aligned} \tag{2.3}$$

where  $\beta = (\vec{x}''')^2$ , equation (2.3) denote by  $\{\vec{e}_1, \vec{e}_2, \vec{e}_3\}$  the moving E. Cartan frame along the isotropic curve  $\vec{x}$  in the space  $C^3$ .

The inner products of these frame vectors are given by

$$\vec{e}_i \cdot \vec{e}_j = \begin{cases} 0 & \text{if } i + j \equiv 1, 2, 3, \pmod{4} \\ 1 & \text{if } i + j = 4 \end{cases} \quad (2.4)$$

The cross (vectoral) and fixed products of these frame vectors are given by

$$\begin{aligned} \vec{e}_j \wedge \vec{e}_k &= i \vec{e}_{j+k-2} \\ \langle \vec{e}_1, \vec{e}_2 \wedge \vec{e}_3 \rangle &= i \end{aligned} \quad (2.5)$$

for  $j, k = 1, 2, 3$ ,  $s = \int_{t_0}^t -[\vec{x}'(t)]^{\frac{1}{4}} dt$  is a pseudo arc length, also invariant with respect to parameter  $t$ . Thus the vector  $\vec{e}_1$  and  $\vec{e}_3$  are isotropic vector,  $\vec{e}_2$  is real vector. Cartan derivative formulas can be deduced from equation (2.3) as follows

$$\begin{aligned} \vec{e}_1' &= i \vec{e}_2 \\ \vec{e}_2' &= i(k \vec{e}_1 + \vec{e}_3) \\ \vec{e}_3' &= ik \vec{e}_2 \end{aligned} \quad (2.6)$$

where  $k = \frac{\beta}{2}$  is called pseudo curvature of isotropic curve  $x = x(s)$ . These equations can be used if the minimal curve is at least of class  $C^4$ . Here (i) denotes derivative according to pseudo arc length  $s$ . In the rest of the paper, we will suppose pseudo curvature is non-vanishing except in the case of an isotropic cubic. Isotropic sphere with center  $\vec{m}$  and radius  $r > 0$  in  $C^3$  is defined by

$$S^2 = \{ \vec{p} = (p_1, p_2, p_3) \in C^3 : (\vec{p} - \vec{m})^2 = 0 \}.$$

### §3. Type-1 $e_1^\alpha e_3^\alpha$ -Isotropic Smarandache Curves

**Definition 3.1** Let  $\alpha = \alpha(s)$  be a unit speed regular isotropic curve in  $C^3$  and  $\{e_1^\alpha, e_2^\alpha, e_3^\alpha\}$  be its moving Cartan frame. Type-1  $e_1^\alpha e_3^\alpha$ -isotropic Smarandache curves can be defined by

$$\vartheta(s^*) = \frac{1}{\sqrt{2}}(e_1^\alpha + e_3^\alpha). \quad (3.1)$$

Now, we can investigate Cartan invariants of  $e_1^\alpha e_3^\alpha$ -isotropic Smarandache curves according to  $\alpha = \alpha(s)$ . Differentiating equation (3.1) with respect to pseudo arc length  $s$ , we obtain

$$\vartheta' = \frac{d\vartheta}{ds^*} \frac{ds^*}{ds} = -\frac{i}{\sqrt{2}}(1 + k^\alpha)e_2^\alpha \quad (3.2)$$

where

$$\frac{ds^*}{ds} = \frac{(1 + k^\alpha)i}{\sqrt{2}}. \quad (3.3)$$



The tangent isotropic vector of curve  $\vartheta$  can be expressed as follow

$$e_1^\vartheta = -\sqrt{1+k^\alpha}e_2^\alpha \quad (3.4)$$

Differentiating equation (3.4) with respect to pseudo arc length  $s$ , we obtain

$$(e_1^\vartheta)' \frac{ds^*}{ds} = 2(1+k^\alpha)ie_1^\alpha + (k^\alpha)'e_2^\alpha + 2(1+k^\alpha)ie_3^\alpha. \quad (3.5)$$

Substituting equation (3.3) into equation (3.5), we find

$$(e_1^\vartheta)' = \left(2\sqrt{2}k^\alpha\right)e_1^\alpha - \left(\frac{\sqrt{2}(k^\alpha)'}{1+k^\alpha}i\right)e_2^\alpha + 2\sqrt{2}e_3^\alpha.$$

Since  $(e_1^\vartheta)' = -ie_2^\vartheta$ , the principal vector field of curve  $\vartheta$

$$e_2^\vartheta = \left(2\sqrt{2}k^\alpha\right)e_1^\alpha - \left(\frac{\sqrt{2}(k^\alpha)'}{1+k^\alpha}\right)ie_2^\alpha + 2\sqrt{2}e_3^\alpha. \quad (3.6)$$

Using Cartan equation (2.6)<sub>3</sub>, we have

$$e_3^\vartheta = i \int k^\vartheta \left[ 2\sqrt{2}k^\alpha e_1^\alpha + \frac{\sqrt{2}(k^\alpha)'}{1+k^\alpha}e_2^\alpha + 2\sqrt{2}ie_3^\alpha \right] ds \quad (3.7)$$

and

$$k^\vartheta = -\frac{(e_3^\vartheta)'}{e_2^\vartheta}i. \quad (3.8)$$

Substituting equations (3.6) and (3.7) into equation (3.8), we obtain

$$k^\vartheta = \frac{\left\{ i \int k^\vartheta \left[ 2\sqrt{2}k^\alpha e_1^\alpha + \frac{\sqrt{2}(k^\alpha)'}{1+k^\alpha}e_2^\alpha + 2\sqrt{2}ie_3^\alpha \right] ds \right\}'}{2\sqrt{2}k^\alpha e_1^\alpha + \frac{\sqrt{2}(k^\alpha)'}{1+k^\alpha}e_2^\alpha + 2\sqrt{2}ie_3^\alpha}i. \quad (3.9)$$

**Proposition 3.1** *If  $\vartheta$  a isotropic Smarandache curves in  $C^3$ , then  $k^\alpha = -1$ .*

*Proof* Using equation (3.4) and definition isotropic curves, it is seen straightforwardly.  $\square$

**Proposition 3.2** *Let  $\alpha = \alpha(s)$  be a unit speed regular isotropic curve in  $C^3$ , If  $\delta$  a isotropic cubic in  $C^3$ , then pseudo curvature of  $\alpha$  satisfies  $e_3^\vartheta = \text{constant}$  and  $e_2^\vartheta \neq 0$ .*

*Proof* It is seen straightforwardly from definition isotropic cubic.  $\square$

#### §4. Type-2 $e_1^\alpha e_3^\alpha$ -Isotropic Smarandache Curves

**Definition 4.1** *Let  $\alpha = \alpha(s)$  be a unit speed regular isotropic curve in  $C^3$  and  $\{e_1^\alpha, e_2^\alpha, e_3^\alpha\}$  be*

its moving Cartan frame. Type-2  $e_1^\alpha e_3^\alpha$ -isotropic Smarandache curves can be defined by

$$\delta(s^*) = \frac{i}{\sqrt{2}}(e_1^\alpha - e_3^\alpha). \quad (4.1)$$

Now, we can investigate Cartan invariants of type-2  $e_1^\alpha e_3^\alpha$ -isotropic Smarandache curves according to  $\alpha = \alpha(s)$ . Differentiating equation (4.1) with respect to pseudo arc length  $s$ , we obtain

$$\delta' = \frac{d\delta}{ds^*} \frac{ds^*}{ds} = -\frac{1}{\sqrt{2}}(k^\alpha - 1)e_2^\alpha \quad (4.2)$$

and

$$e_1^\delta \frac{ds^*}{ds} = -\frac{1}{\sqrt{2}}(k^\alpha - 1)e_2^\alpha$$

where

$$\frac{ds^*}{ds} = \frac{\sqrt{k^\alpha - 1}}{\sqrt{2}}. \quad (4.3)$$

The tangent isotropic vector of curve  $\delta$  can be expressed as follow

$$e_1^\delta = -\sqrt{k^\alpha - 1}e_2^\alpha \quad (4.4)$$

Differentiating equation (4.4) with respect to pseudo arc length  $s$ , we obtain

$$e_2^\delta = \sqrt{k^\alpha - 1}k^\alpha e_1^\alpha - \frac{i(k^\alpha)'}{2\sqrt{k^\alpha - 1}}e_2^\alpha + \sqrt{k^\alpha - 1}e_3^\alpha. \quad (4.5)$$

Using definition, binormal vector field and pseudo curvature of isotropic Smarandache curve  $\delta$  are respectively,

$$e_3^\delta = i \int k^\delta \left[ \sqrt{k^\alpha - 1}k^\alpha e_1^\alpha - \frac{i(k^\alpha)'}{2\sqrt{k^\alpha - 1}}e_2^\alpha + \sqrt{k^\alpha - 1}e_3^\alpha \right] ds \quad (4.6)$$

and

$$k^\delta = \frac{\left\{ -i \int k^\delta \left[ \sqrt{k^\alpha - 1}k^\alpha e_1^\alpha - \frac{i(k^\alpha)'}{2\sqrt{k^\alpha - 1}}e_2^\alpha + \sqrt{k^\alpha - 1}e_3^\alpha \right] ds \right\}'}{\sqrt{k^\alpha - 1}k^\alpha e_1^\alpha - \frac{i(k^\alpha)'}{2\sqrt{k^\alpha - 1}}e_2^\alpha + \sqrt{k^\alpha - 1}e_3^\alpha} i. \quad (4.7)$$

**Proposition 4.1** *If  $\delta$  a isotropic Smarandache curves in  $C^3$ , then  $k^\alpha = 1$ .*

*Proof* Using equation (4.4) and definition isotropic curves, it is seen straightforwardly.  $\square$

**Proposition 4.2** *Let  $\alpha = \alpha(s)$  be a unit speed regular isotropic curve in  $C^3$ , If  $\delta$  a isotropic cubic in  $C^3$ , then pseudo curvature of  $\alpha$  satisfies  $e_3^\delta = \text{constant}$  and  $e_2^\delta \neq 0$ .*

*Proof* It is seen straightforwardly from definition isotropic cubic.  $\square$

### §5. $e_1^\alpha e_2^\alpha e_3^\alpha$ -Isotropic Smarandache Curves

**Definition 5.1** Let  $\alpha = \alpha(s)$  be a unit speed regular isotropic curve in  $C^3$  and  $\{e_1^\alpha, e_2^\alpha, e_3^\alpha\}$  be its moving Cartan frame. Type-1  $e_1^\alpha e_3^\alpha$ -isotropic Smarandache curves can be defined by

$$\eta(s^*) = \frac{1}{\sqrt{3}}(e_1^\alpha + e_2^\alpha + e_3^\alpha). \quad (5.1)$$

Now, we can investigate Cartan invariants of  $e_1^\alpha e_2^\alpha e_3^\alpha$ -isotropic Smarandache curves according to  $\alpha = \alpha(s)$ . Differentiating equation (5.1) with respect to pseudo arc length  $s$ , we have

$$\eta' = \frac{d\eta}{ds^*} \frac{ds^*}{ds} = \frac{1}{\sqrt{3}} [ik^\alpha e_1^\alpha - i(k^\alpha + 1)e_2^\alpha + ie_3^\alpha] \quad (5.2)$$

and

$$\eta' = e_1^\eta \frac{ds^*}{ds} = \frac{1}{\sqrt{3}} [ik^\alpha e_1^\alpha - i(k^\alpha + 1)e_2^\alpha + ie_3^\alpha]$$

where

$$\frac{ds^*}{ds} = \frac{\sqrt{1+k^\alpha}}{\sqrt{3}}. \quad (5.3)$$

The tangent isotropic vector of curve  $\eta$  can be written as follow:

$$e_1^\eta = \frac{1}{\sqrt{1+k^\alpha}} [ik^\alpha e_1^\alpha - i(k^\alpha + 1)e_2^\alpha + ie_3^\alpha] \quad (5.4)$$

Differentiating equation (5.4) with respect to pseudo arc length  $s$ , we obtain

$$\begin{aligned} e_2^\eta = & \left\{ \left( \frac{-\sqrt{3}}{1+k^\alpha} \right) [i(k^\alpha)' + (k^\alpha + 1)k] - \left( \frac{-\sqrt{3}}{1+k^\alpha} \right)' ik^\alpha \right\} e_1^\alpha \\ & - \left\{ \left( \frac{\sqrt{3}}{1+k^\alpha} \right) [-2k^\alpha + (k^\alpha + 1)'] - \left( \frac{-\sqrt{3}}{1+k^\alpha} \right)' (k^\alpha + 1) \right\} e_2^\alpha \\ & - \left\{ \left( \frac{-\sqrt{3}}{1+k^\alpha} \right)' + \left( \frac{\sqrt{3}}{1+k^\alpha} \right) \right\} e_3^\alpha \end{aligned}$$

Using definition, binormal vector field and pseudo curvature of isotropic Smarandache curve  $\eta$  are respectively

$$\begin{aligned} e_3^\eta = & -i \int k^\eta \left\{ \left( \frac{-\sqrt{3}}{1+k^\alpha} \right) [(k^\alpha)' + (k^\alpha + 1)k^\alpha] - \left( \frac{-\sqrt{3}}{1+k^\alpha} \right)' ik^\alpha \right\} e_1^\alpha \\ & - \left\{ \left( \frac{\sqrt{3}}{1+k^\alpha} \right) [2k^\alpha + (k^\alpha + 1)'] - \left( \frac{-\sqrt{3}}{1+k^\alpha} \right)' (k^\alpha + 1) \right\} e_2^\alpha \\ & - \left\{ \left( \frac{\sqrt{3}}{1+k^\alpha} \right)' + \left( \frac{\sqrt{3}}{1+k^\alpha} \right) \right\} e_3^\alpha \} ds \end{aligned}$$

Let  $e_3^\eta = H(s)$  and  $e_2^\eta = G(s)$  in this case, we have

$$k^\eta = \frac{(H(s))'}{G(s)}. \quad (5.5)$$

**Proposition 5.1** If  $\eta$  a isotropic Smarandache curves in  $C^3$ , then  $k^\alpha \neq -1$ .

*Proof* Using equation (5.4) and definition isotropic curves, it is seen straightforwardly.  $\square$

**Proposition 5.2** Let  $\alpha = \alpha(s)$  be a unit speed regular isotropic curve in  $C^3$ , If  $\eta$  a isotropic cubic in  $C^3$ , then pseudo curvature of  $\alpha$  satisfies  $e_3^\eta = \text{constant}$  and  $e_2^\eta \neq 0$ .

*Proof* It is seen straightforwardly from definition isotropic cubic.  $\square$

## References

- [1] F. Şemin, *Differential Geometry I*, Istanbul University, Science Faculty Press, 1983.
- [2] U. Pekmen, On minimal space curves in the sense of Bertrand curves, *Univ. Beograd. Publ. Elektrotehn. Fak. Ser. Mat.* 10, 38, 1999.
- [3] S. Yilmaz and M. Turgut, Some Characterizations of Isotropic Curves in the Euclidean Space, *Int. J. Comput. Math. Sci.*, 2(2), 2008, 107-109.
- [4] F. Akbulut, *Vector Calculus*, Ege University Press, İzmir, 1981.
- [5] S. Yilmaz, Contributions to differential geometry of isotropic curves in the complex space, *J. Math. Anal. Appl.*, 374, 673680, 2011.
- [6] E. Altinisik, *Complex curves in  $R^4$* , Dissertation, Dokuz Eylül University, Izmir, 1997
- [7] M. Turgut, S. Yilmaz, Smarandache Curves in Minkowski SpaceTime, *International J. Math. Combin.* 2008; 3,: 51-55.
- [8] M. Turgut, Smarandache Breadth Pseudo Null Curves in Minkowski Space-Time, *International J. Math. Combin.*, 2009; 1: 46-49.
- [9] A.T. Ali, Special Smarandache Curves in The Euclidean Space, *Math. Cobin. Bookser*, 2010;2: 30-36.
- [10] M. Cetin, Y.Tuncer and M. K. Karacan, Smarandache Curves According to Bishop Frame in Euclidean 3-Space, *Gen. Math. Notes*, 2014; 20: 50-56.
- [11] K. Taskopru, M.Tosun, Smarandache Curves on  $S^2$ , *Bol. Soc. Paran. Mat.*, 2014; 32(1): 51-59
- [12] N. Bayrak, O. Bektaş and S. Yüce, Special Smarandache Curves in  $E_1^3$ , *Mathematical Physics. and* <http://arxiv.org/abs/1204.5656>.
- [13] A.T. Ali, R. Lopez, Slant helices in Minkowski space  $E_1^3$ , *J. Korean Math. Soc.*, 48, 159-167, 2011.
- [14] S. Izumiya, N. Takeuchi, New special curves and developable surfaces, *Turkish J. Math.*, 28(2), 531537, 2004.
- [15] L. Kula, Y. Yaylı, On Slant Helix and Its Spherical Indicatrix, *Appl. Math. Comput.*, 169 (1)(2005), 600-607.

## 2-Pseudo Neighbourly Irregular Intuitionistic Fuzzy Graphs

S.Ravi Narayanan

Department of Mathematics

Karpaga Vinayaga College of Engineering and Technology, Chennai, Tamil Nadu, India

S.Murugesan

PG and Research Department of Mathematics, Sri S.R.N.M. College, Sattur- 626 203, Tamil Nadu, India

E-mail: ravimathsdept@gmail.com, satturmuruges@gmail.com

**Abstract:** In this paper, 2-pseudo neighbourly irregular intuitionistic fuzzy graph, 2-pseudo neighbourly totally irregular intuitionistic fuzzy graph are introduced and compared through various examples. A necessary and sufficient condition under which they are equivalent is provided. 2- pseudo neighbourly irregularity on some intuitionistic fuzzy graphs whose underlying crisp graphs are a cycle  $C_n$ , a Bi-star graph  $B_{n,m}$ ,  $\text{Sub}(B_{n,m})$ , and a path  $P_n$  are studied.

**Key Words:** Degree of a vertex in an intuitionistic fuzzy graph,  $d_2$ -degree of a vertex in an intuitionistic fuzzy graph, total  $d_2$ -degree, pseudo degree, pseudo total degree,neighbourly irregular intuitionistic fuzzy graph.

**AMS(2010):** 05C12, 03E72, 05C72.

### §1. Introduction

The first definition of fuzzy graph was introduced by Kaufmann [9] in 1975, based on Zadeh's fuzzy relations in 1965 ([17]). Atanassov [4] introduced the concept of intuitionistic fuzzy (IF) relations and Intuitionistic Fuzzy Graphs (IFGs). Parvathi and Karunambigai [12] introduced the concept of IFG elaborately and analyzed its components. S. Ravi Narayanan and S. Murugesan [13] introduced Pseudo Regular Intuitionistic Fuzzy Graphs. A. Nagoor Gani, R. Jahir Hussain and S. Yahya Mohamed [11] introduced Neighbourly Irregular Intuitionistic Fuzzy Graphs. Articles [4, 11, 12, 13] motivated us to introduce 2- pseudo neighbourly irregular intuitionistic fuzzy graph, 2- pseudo neighbourly totally irregular intuitionistic fuzzy graph and analyze some of its properties.

In Section 2, we review some basic concepts and definitions. Section 3 deals with 2-pseudo neighbourly irregular intuitionistic fuzzy graphs and 2-pseudo neighbourly totally irregular intuitionistic fuzzy graphs. Comparative study between them is made and necessary and sufficient condition is provided. Section 4 deals with 2-pseudo neighbourly irregularity on cycle with some

---

<sup>1</sup>Received May 26, 2016, Accepted November 4, 2016.

specific membership function. Section 5 deals with 2-pseudo neighbourly irregularity on bi-star graph  $B_{n,m}$  with some specific membership function. Section 6 deals with 2-pseudo neighbourly irregularity on subdivision of bi-star graph with some specific membership function. Section 7 deals with 2-pseudo neighbourly irregularity on a path with some specific membership function.

Throughout this paper, the vertices takes the membership value  $A = (\mu_1, \gamma_1)$  and the edges takes the membership values  $B = (\mu_2, \gamma_2)$ .

## §2. Preliminaries

We present some known definitions related to fuzzy graphs and intuitionistic fuzzy graphs for ready reference to go through the work presented in this paper.

**Definition 2.1**([6]) *A fuzzy graph  $G : (\sigma, \mu)$  is a pair of functions  $(\sigma, \mu)$ , where  $\sigma : V \rightarrow [0,1]$  is a fuzzy subset of a non empty set  $V$  and  $\mu : V \times V \rightarrow [0, 1]$  is a symmetric fuzzy relation on  $\sigma$  such that for all  $u, v$  in  $V$ , the relation  $\mu(u, v) \leq \sigma(u) \wedge \sigma(v)$  is satisfied. A fuzzy graph  $G$  is called complete fuzzy graph if the relation  $\mu(u, v) = \sigma(u) \wedge \sigma(v)$  is satisfied.*

**Definition 2.2**([3]) *An intuitionistic fuzzy graph with underlying set  $V$  is defined to be a pair  $G = (V, E)$  where*

(1)  $V = \{v_1, v_2, v_3, \dots, v_n\}$  such that  $\mu_1 : V \rightarrow [0, 1]$  and  $\gamma_1 : V \rightarrow [0, 1]$  denote the degree of membership and non-membership of the element  $v_i \in V$ ,  $i = 1, 2, 3, \dots, n$ , such that  $0 \leq \mu_1(v_i) + \gamma_1(v_i) \leq 1$ ;

(2)  $E \subseteq V \times V$ , where  $\mu_2 : V \times V \rightarrow [0, 1]$  and  $\gamma_2 : V \times V \rightarrow [0, 1]$  are such that  $\mu_2(v_i, v_j) \leq \min\{\mu_1(v_i), \mu_1(v_j)\}$  and  $\gamma_2(v_i, v_j) \leq \max\{\gamma_1(v_i), \gamma_1(v_j)\}$  and  $0 \leq \mu_2(v_i, v_j) + \gamma_2(v_i, v_j) \leq 1$  for every  $(v_i, v_j) \in E$ ,  $i, j = 1, 2, \dots, n$ .

**Definition 2.3**([8]) *If  $v_i, v_j \in V \subseteq G$ , the  $\mu$ -strength of connectedness between two vertices  $v_i$  and  $v_j$  is defined as  $\mu_2^\infty(v_i, v_j) = \sup\{\mu_2^k(v_i, v_j) : k = 1, 2, \dots, n\}$  and  $\gamma$ -strength of connectedness between two vertices  $v_i$  and  $v_j$  is defined as  $\gamma_2^\infty(v_i, v_j) = \inf\{\gamma_2^k(v_i, v_j) : k = 1, 2, \dots, n\}$ .*

*If  $u$  and  $v$  are connected by means of paths of length  $k$  then  $\mu_2^k(u, v)$  is defined as  $\sup\{\mu_2(u, v_1) \wedge \mu_2(v_1, v_2) \wedge \dots \wedge \mu_2(v_{k-1}, v) : (u, v_1, v_2, \dots, v_{k-1}, v) \in V\}$  and  $\gamma_2^k(u, v)$  is defined as  $\inf\{\gamma_2(u, v_1) \wedge \gamma_2(v_1, v_2) \wedge \dots \wedge \gamma_2(v_{k-1}, v) : (u, v_1, v_2, \dots, v_{k-1}, v) \in V\}$ .*

**Definition 2.4**([8]) *Let  $G : (A, B)$  be an intuitionistic fuzzy graph on  $G^*(V, E)$ . Then the degree of a vertex  $v_i \in G$  is defined by  $d(v_i) = (d_{\mu_1}(v_i), d_{\gamma_1}(v_i))$ , where  $d_{\mu_1}(v_i) = \sum \mu_2(v_i, v_j)$  and  $d_{\gamma_1}(v_i) = \sum \gamma_2(v_i, v_j)$ , for  $(v_i, v_j) \in E$  and  $\mu_2(v_i, v_j) = 0$  and  $\gamma_2(v_i, v_j) = 0$  for  $(v_i, v_j) \notin E$ .*

**Definition 2.5**([8]) *Let  $G : (A, B)$  be an intuitionistic fuzzy graph on  $G^*(V, E)$ . Then the total degree of a vertex  $v_i \in G$  is defined by  $td(v_i) = (td_{\mu_1}(v_i), td_{\gamma_1}(v_i))$ , where  $td_{\mu_1}(v_i) = d_{\mu_1}(v_i) + \mu_1(v_i)$  and  $td_{\gamma_1}(v_i) = d_{\gamma_1}(v_i) + \gamma_1(v_i)$ .*

**Definition 2.6**([13]) *Let  $G : (A, B)$  be an intuitionistic fuzzy graph. The membership pseudo degree of a vertex  $u \in G$  is defined as  $d_{(a)}\mu_1(u) = \frac{t_\mu}{d_i}$  where  $t_\mu$  is the sum of membership degrees of vertices incident with vertex  $u$ . The non-membership pseudo degree of a vertex  $u \in G$  is*

defined as  $d_{(a)}\gamma_1(u) = \frac{t_\gamma}{d_i}$  where  $t_\gamma$  is the sum of non-membership degrees of vertices incident with vertex  $u$  and  $d_i$  is the total number of edges incident with the vertex  $u$ . The pseudo degree of a vertex  $u \in G$  is defined as  $d_{(a)}(u) = (d_{(a)}\mu_1(u), d_{(a)}\gamma_1(u))$ .

**Definition 2.7**([13]) Let  $G : (A, B)$  be an intuitionistic fuzzy graph. The pseudo total degree of a vertex  $u \in G$  is defined as  $td_{(a)}(u) = (td_{(a)}\mu_1(u), td_{(a)}\gamma_1(u))$  where  $td_{(a)}\mu_1(u) = d_{(a)}\mu_1(u) + \mu_1(u)$  and  $td_{(a)}\gamma_1(u) = d_{(a)}\gamma_1(u) + \gamma_1(u)$ . It can also be defined as  $td_{(a)}(u) = d_{(a)}(u) + A(u)$ .

**Definition 2.8**([13]) Let  $G : (A, B)$  be an intuitionistic fuzzy graph. The membership  $d_2$  - pseudo degree of a vertex  $u \in G$  is defined as  $d_{(a)(2)}\mu_1(u) = \frac{\sum d_{(2)}\mu_1(u)}{d_i}$ . The non-membership  $d_2$ -pseudo degree of a vertex  $u \in G$  is defined as  $d_{(a)(2)}\gamma_1(u) = \frac{\sum d_{(2)}\gamma_1(u)}{d_i}$  where  $d_i$  is the number of edges incident with the vertex  $u$ . The  $d_2$  - pseudo degree of a vertex  $u$  is defined as  $d_{(a)(2)}(u) = (d_{(a)(2)}\mu_1(u), d_{(a)(2)}\gamma_1(u))$ .

**Definition 2.9**([13]) Let  $G : (A, B)$  be an intuitionistic fuzzy graph. Then the  $d_2$ -pseudo total degree of a vertex  $u \in V$  is defined as  $td_{(a)(2)}(u) = (td_{(a)(2)}\mu_1(u), td_{(a)(2)}\gamma_1(u))$ , where  $td_{(a)(2)}\mu_1(u) = d_{(a)(2)}\mu_1(u) + \mu_1(u)$  and  $td_{(a)(2)}\gamma_1(u) = d_{(a)(2)}\gamma_1(u) + \gamma_1(u)$ . Also it can be defined as  $td_{(a)(2)}(u) = d_{(a)(2)}(u) + A(u)$  where  $A(u) = (\mu_1(u), \gamma_1(u))$ .

**Definition 2.10**([11]) Let  $G : (A, B)$  be an intuitionistic fuzzy graph. Then  $G$  is said to be neighbourly irregular intuitionistic fuzzy graph if every two adjacent vertices have distinct degrees.

**Definition 2.11**([14]) Let  $G : (A, B)$  be an intuitionistic fuzzy graph. If  $d_{(a)}(v) = (r_1, r_2)$  and  $d_{(a)(2)}(v) = (c_1, c_2)$ , then  $G$  is said to be  $((r_1, r_2), 2, (c_1, c_2))$ - pseudo regular intuitionistic fuzzy graph.

### §3. 2-Pseudo Neighbourly Irregular Intuitionistic Fuzzy Graphs

In this section, 2-pseudo neighbourly irregular and 2-pseudo neighbourly totally irregular intuitionistic fuzzy graphs are defined. A necessary and sufficient condition under which they are equivalent is provided.

**Definition 3.1** Let  $G : (A, B)$  be a connected intuitionistic fuzzy graph. Then  $G$  is said to be 2-pseudo neighbourly irregular intuitionistic fuzzy graph if every two adjacent vertices of  $G$  have distinct  $d_2$ -pseudo degrees.

**Example 3.2** Consider an intuitionistic fuzzy graph on  $G^* : (V, E)$ .

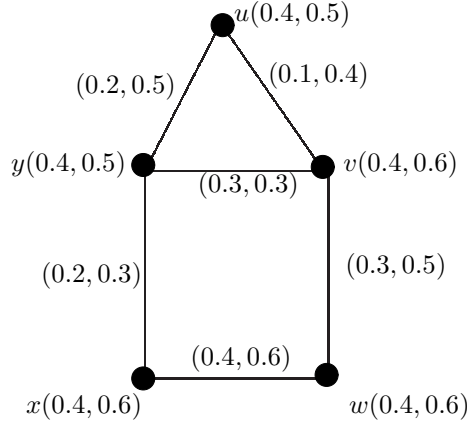

Figure 1

Here,  $d_{(a)(2)}(u) = (0.3, 0.55)$ ,  $d_{(a)(2)}(v) = (0.33, 0.83)$ ,  $d_{(a)(2)}(w) = (0.4, 0.8)$ ,  $d_{(a)(2)}(x) = (0.35, 0.75)$  and  $d_{(a)(2)}(y) = (0.37, 0.87)$ .

So, every two adjacent vertices have distinct  $d_2$ -pseudo degrees. Hence  $G$  is 2-pseudo neighbourly irregular intuitionistic fuzzy graph.

**Definition 3.3** If every two adjacent vertices of an intuitionistic fuzzy graph  $G : (A, B)$  have distinct  $d_2$  -pseudo total degrees, then  $G$  is said to be 2-pseudo neighbourly totally irregular intuitionistic fuzzy graph.

**Example 3.4** Consider an intuitionistic fuzzy graph on  $G^* : (V, E)$ .

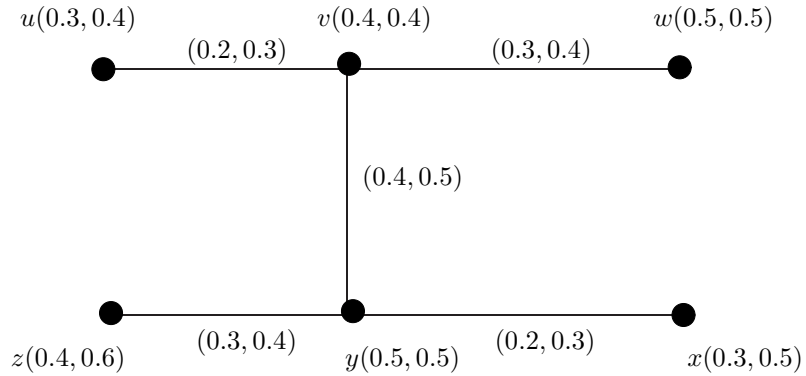

Figure 2

Here,  $td_{(a)(2)}(u) = (0.8, 1.4)$ ,  $td_{(a)(2)}(v) = (0.87, 1.13)$ ,  $td_{(a)(2)}(w) = (1, 1.5)$ ,  $td_{(a)(2)}(x) = (0.8, 1.5)$ ,  $td_{(a)(2)}(y) = (0.97, 1.43)$  and  $td_{(a)(2)}(z) = (0.9, 1.6)$ .

So, every two adjacent vertices have distinct  $d_2$ -pseudo total degrees. Hence  $G$  is 2-pseudo neighbourly totally irregular intuitionistic fuzzy graph.

**Remark 3.5** A 2-pseudo neighbourly irregular intuitionistic fuzzy graph need not be a 2-pseudo neighbourly totally irregular intuitionistic fuzzy graph.

**Remark 3.6** A 2-pseudo neighbourly totally irregular intuitionistic fuzzy graph need not be a 2-pseudo neighbourly irregular intuitionistic fuzzy graph.



**Proposition 3.7** *If the membership value of the adjacent vertices are distinct, then  $((r_1, r_2), 2, (c_1, c_2))$ -pseudo regular intuitionistic fuzzy graph is 2-pseudo neighbourly totally irregular intuitionistic fuzzy graph.*

*Proof* The proof is obvious.  $\square$

**Theorem 3.8** *Let  $G : (A, B)$  be an intuitionistic fuzzy graph on  $G^* : (V, E)$ . If  $G$  is a 2-pseudo neighbourly irregular intuitionistic fuzzy graph and  $A$  is a constant function, then  $G$  is a 2-pseudo neighbourly totally irregular intuitionistic fuzzy graph.*

*Proof* Let  $G : (A, B)$  be a 2-pseudo neighbourly irregular intuitionistic fuzzy graph. Then the  $d_2$ -pseudo degree of every two adjacent vertices are distinct. Let  $u$  and  $v$  be two adjacent vertices with distinct  $d_2$ -pseudo degrees. This implies that  $d_{(a)(2)}(u) = (k_1, k_2)$  and  $d_{(a)(2)}(v) = (k_3, k_4)$ , where  $k_1 \neq k_3$ ,  $k_2 \neq k_4$  and  $A(u) = A(v) = (c_1, c_2)$ , a constant where  $c_1, c_2 \in [0, 1]$ . Suppose  $td_{(a)(2)}(u) = td_{(a)(2)}(v) \Rightarrow d_{(a)(2)}(u) + A(u) = d_{(a)(2)}(v) + A(v) \Rightarrow (k_1, k_2) + (c_1, c_2) = (k_3, k_4) + (c_1, c_2) \Rightarrow (k_1, k_2) = (k_3, k_4)$ , which is a contradiction. So,  $td_{(a)(2)}(u) \neq td_{(a)(2)}(v)$ . Hence any two adjacent vertices  $u$  and  $v$  with distinct  $d_2$ -pseudo degrees have their  $d_2$ -pseudo total degrees distinct, provided  $A$  is a constant function. This is true for every pair of adjacent vertices in  $G$ . Hence  $G$  is 2-pseudo neighbourly totally irregular intuitionistic fuzzy graph.  $\square$

**Theorem 3.9** *Let  $G : (A, B)$  be an intuitionistic fuzzy graph on  $G^* : (V, E)$ . If  $G$  is a 2-pseudo neighbourly totally irregular intuitionistic fuzzy graph and  $A$  is a constant function, then  $G$  is a 2-pseudo neighbourly irregular intuitionistic fuzzy graph.*

*Proof* Let  $G : (A, B)$  be a 2-pseudo neighbourly totally irregular intuitionistic fuzzy graph. Then the  $d_2$ -pseudo total degree of every two adjacent vertices are distinct. Let  $u$  and  $v$  be two adjacent vertices with  $d_2$ -pseudo degrees  $(k_1, k_2)$  and  $(k_3, k_4)$ . Then  $d_{(a)(2)}(u) = (k_1, k_2)$  and  $d_{(a)(2)}(v) = (k_3, k_4)$ . Given that  $A(u) = A(v) = (c_1, c_2)$ , a constant where  $c_1, c_2 \in [0, 1]$  and  $td_{(a)(2)}(u) \neq td_{(a)(2)}(v)$ . Since,  $td_{(a)(2)}(u) \neq td_{(a)(2)}(v) \Rightarrow d_{(a)(2)}(u) + A(u) \neq d_{(a)(2)}(v) + A(v) \Rightarrow (k_1, k_2) + (c_1, c_2) \neq (k_3, k_4) + (c_1, c_2) \Rightarrow (k_1, k_2) \neq (k_3, k_4) \Rightarrow d_{(a)(2)}(u) \neq d_{(a)(2)}(v)$ . Hence any two adjacent vertices  $u$  and  $v$  with distinct  $d_2$ -pseudo total degrees have their  $d_2$ -pseudo degrees distinct, provided  $A$  is a constant function. This is true for every pair of adjacent vertices in  $G$ . Hence  $G$  is 2-pseudo neighbourly irregular intuitionistic fuzzy graph.  $\square$

**Remark 3.10** Let  $G : (A, B)$  be an intuitionistic fuzzy graph on  $G^* : (V, E)$ . Theorems 3.8 and 3.9 jointly yield the following result. If  $A$  is a constant function, then  $G$  is a 2-pseudo neighbourly totally irregular intuitionistic fuzzy graph if and only if  $G$  is a 2-pseudo neighbourly irregular intuitionistic fuzzy graph.

**Remark 3.11** Let  $G : (A, B)$  be an intuitionistic fuzzy graph on  $G^* : (V, E)$ . If  $G$  is both 2-pseudo neighbourly irregular intuitionistic fuzzy graph and  $G$  is a 2-pseudo neighbourly totally irregular intuitionistic fuzzy graph. Then  $A$  need not be a constant function.

#### §4. 2-Pseudo Neighbourly Irregular Intuitionistic Fuzzy Graph on a Cycle with Some Specific Membership Functions

In this section, Theorems 4.1 and 4.4 provide 2-pseudo neighbourly irregularity on intuitionistic

fuzzy graph  $G : (A, B)$  on a cycle  $G^* : (V, E)$ .

**Theorem 4.1** *Let  $G : (A, B)$  be an intuitionistic fuzzy graph on a cycle  $G^* : (V, E)$  of length  $n$ . If the values of the edges  $e_1, e_2, e_3, \dots, e_n$  are respectively  $(c_1, k_1), (c_2, k_2), (c_3, k_3), \dots, (c_n, k_n)$  such that  $c_i < c_{i+1}$  and  $k_i > k_{i+1}$ , for  $i = 1, 2, \dots, n - 1$ , then  $G$  is a 2-pseudo neighbourly irregular intuitionistic fuzzy graph.*

*Proof* Let  $G : (A, B)$  be an intuitionistic fuzzy graph on a cycle  $G^* : (V, E)$  of length  $n$ . Let  $e_1, e_2, e_3, \dots, e_n$  be the edges of the cycle of  $G^*$  in that order. Let the values of the edges  $e_1, e_2, e_3, \dots, e_n$  be  $(c_1, k_1), (c_2, k_2), (c_3, k_3), \dots, (c_n, k_n)$  such that  $c_i < c_{i+1}$  and  $k_i > k_{i+1}$  for  $i = 1, 2, \dots, n - 1$

$$\begin{aligned} d_{(2)}\mu_1(v_1) &= \{\mu_2(e_1) \wedge \mu_2(e_2)\} + \{\mu_2(e_n) \wedge \mu_2(e_{n-1})\} \\ &= \{c_1 \wedge c_2\} + \{c_n \wedge c_{n-1}\} \\ &= c_1 + c_{n-1}. \end{aligned}$$

$$\begin{aligned} d_{(2)}\mu_1(v_2) &= \{\mu_2(e_1) \wedge \mu_2(e_n)\} + \{\mu_2(e_2) \wedge \mu_2(e_3)\} \\ &= \{c_1 \wedge c_n\} + \{c_2 \wedge c_3\} \\ &= c_1 + c_2. \end{aligned}$$

For  $i = 3, 4, 5, \dots, n - 1$ ,

$$\begin{aligned} d_{(2)}\mu_1(v_i) &= \{\mu_2(e_{i-1}) \wedge \mu_2(e_{i-2})\} + \{\mu_2(e_{i+1}) \wedge \mu_2(e_i)\} \\ &= \{c_{i-1} \wedge c_{i-2}\} + \{c_i \wedge c_{i+1}\} \\ &= c_{i-2} + c_i. \end{aligned}$$

$$\begin{aligned} d_{(2)}\mu_1(v_n) &= \{\mu_2(e_1) \wedge \mu_2(e_n)\} + \{\mu_2(e_{n-1}) \wedge \mu_2(e_{n-2})\} \\ &= \{c_1 \wedge c_n\} + \{c_{n-1} \wedge c_{n-2}\} \\ &= c_1 + c_{n-2}. \end{aligned}$$

$$\begin{aligned} d_{(2)}\gamma_1(v_1) &= \{\gamma_2(e_1) \vee \gamma_2(e_2)\} + \{\gamma_2(e_n) \vee \gamma_2(e_{n-1})\} \\ &= \{k_1 \vee k_2\} + \{k_n \vee k_{n-1}\} \\ &= k_1 + k_{n-1}. \end{aligned}$$

$$\begin{aligned} d_{(2)}\gamma_1(v_2) &= \{\gamma_2(e_1) \vee \gamma_2(e_n)\} + \{\gamma_2(e_2) \vee \gamma_2(e_3)\} \\ &= \{k_1 \vee k_n\} + \{k_2 \vee k_3\} \\ &= k_1 + k_2. \end{aligned}$$

For  $i = 3, 4, 5, \dots, n-1$ ,

$$\begin{aligned} d_{(2)}\gamma_1(v_i) &= \{\gamma_2(e_{i-1}) \vee \gamma_2(e_{i-2})\} + \{\gamma_2(e_{i+1}) \vee \gamma_2(e_i)\} \\ &= \{k_{i-1} \vee k_{i-2}\} + \{k_i \vee k_{i+1}\} \\ &= k_{i-2} + k_i. \end{aligned}$$

$$\begin{aligned} d_{(2)}\gamma_1(v_n) &= \{\gamma_2(e_1) \vee \gamma_2(e_n)\} + \{\gamma_2(e_{n-1}) \vee \gamma_2(e_{n-2})\} \\ &= \{k_1 \wedge k_n\} + \{k_{n-1} \wedge k_{n-2}\} \\ &= k_1 + k_{n-2}. \end{aligned}$$

Every two adjacent vertices have distinct  $d_2$ -pseudo degrees. Hence  $G$  is a 2- pseudo neighbourly irregular intuitionistic fuzzy graph.  $\square$

**Remark 4.2** Even if the values of the edges  $e_1, e_2, e_3, \dots, e_n$  are respectively  $(c_1, k_1), (c_2, k_2), (c_3, k_3), \dots, (c_n, k_n)$  such that  $c_i < c_{i+1}$  and  $k_i > k_{i+1}$  for  $i = 1, 2, \dots, n-1$  then  $G$  need not be 2- pseudo neighbourly totally irregular intuitionistic fuzzy graph.

**Theorem 4.3** Let  $G : (A, B)$  be an intuitionistic fuzzy graph on a cycle  $G^* : (V, E)$  of length  $n$ . If the values of the edges  $e_1, e_2, e_3, \dots, e_n$  are respectively  $(c_1, k_1), (c_2, k_2), (c_3, k_3), \dots, (c_n, k_n)$  such that  $c_i > c_{i+1}$  and  $k_i < k_{i+1}$ , for  $i = 1, 2, \dots, n-1$ , then  $G$  is a 2-pseudo neighbourly irregular intuitionistic fuzzy graph.

*Proof* Let  $G : (A, B)$  be an intuitionistic fuzzy graph on  $G^* : (V, E)$  of length  $n$ . Let  $e_1, e_2, e_3, \dots, e_n$  be the edges of the cycle  $G^*$  in that order. Let the values of the edges  $e_1, e_2, e_3, \dots, e_n$  be respectively  $(c_1, k_1), (c_2, k_2), (c_3, k_3), \dots, (c_n, k_n)$  such that  $c_i > c_{i+1}$  and  $k_i < k_{i+1}$  for  $i = 1, 2, \dots, n-1$ ,

$$\begin{aligned} d_{(2)}\mu_1(v_1) &= \{\mu_2(e_1) \wedge \mu_2(e_2)\} + \{\mu_2(e_n) \wedge \mu_2(e_{n-1})\} \\ &= \{c_1 \wedge c_2\} + \{c_n \wedge c_{n-1}\} \\ &= c_2 + c_n. \end{aligned}$$

$$\begin{aligned} d_{(2)}\mu_1(v_2) &= \{\mu_2(e_1) \wedge \mu_2(e_n)\} + \{\mu_2(e_2) \wedge \mu_2(e_3)\} \\ &= \{c_1 \wedge c_n\} + \{c_2 \wedge c_3\} \\ &= c_n + c_3. \end{aligned}$$

For  $(3 \leq i \leq n-1)$ ,

$$\begin{aligned} d_{(2)}\mu_1(v_i) &= \{\mu_2(e_{i-1}) \wedge \mu_2(e_{i-2})\} + \{\mu_2(e_{i+1}) \wedge \mu_2(e_i)\} \\ &= \{c_{i-1} \wedge c_{i-2}\} + \{c_i \wedge c_{i+1}\} \\ &= c_{i-1} + c_{i+1}. \end{aligned}$$

$$\begin{aligned}
d_{(2)}\mu_1(v_n) &= \{\mu_2(e_1) \wedge \mu_2(e_n)\} + \{\mu_2(e_{n-1}) \wedge \mu_2(e_{n-2})\} \\
&= \{c_1 \wedge c_n\} + \{c_{n-1} \wedge c_{n-2}\} \\
&= c_n + c_{n-1}.
\end{aligned}$$

Now

$$\begin{aligned}
d_{(2)}\gamma_1(v_1) &= \{\gamma_2(e_1) \vee \gamma_2(e_2)\} + \{\gamma_2(e_n) \vee \gamma_2(e_{n-1})\} \\
&= \{k_1 \vee k_2\} + \{k_n \vee k_{n-1}\} \\
&= k_2 + k_n. \\
d_{(2)}\gamma_1(v_2) &= \{\gamma_2(e_1) \vee \gamma_2(e_n)\} + \{\gamma_2(e_2) \vee \gamma_2(e_3)\} \\
&= \{k_1 \vee k_n\} + \{k_2 \vee k_3\} \\
&= k_n + k_3.
\end{aligned}$$

For  $3 \leq i \leq n-1$ ,

$$\begin{aligned}
d_{(2)}\gamma_1(v_i) &= \{\gamma_2(e_{i-1}) \vee \gamma_2(e_{i-2})\} + \{\gamma_2(e_{i+1}) \vee \gamma_2(e_i)\} \\
&= \{k_{i-1} \vee k_{i-2}\} + \{k_i \vee k_{i+1}\} \\
&= k_{i-1} + k_{i+1}. \\
d_{(2)}\gamma_1(v_n) &= \{\gamma_2(e_1) \vee \gamma_2(e_n)\} + \{\gamma_2(e_{n-1}) \vee \gamma_2(e_{n-2})\} \\
&= \{k_1 \vee k_n\} + \{k_{n-1} \vee k_{n-2}\} \\
&= k_n + k_{n-1}.
\end{aligned}$$

Here, Every two adjacent vertices have distinct  $d_2$ - pseudo degrees. Hence  $G$  is 2-pseudo neighbourly irregular intuitionistic fuzzy graph.  $\square$

**Remark 4.4** Even if the values of the edges  $e_1, e_2, e_3, \dots, e_n$  are respectively  $(c_1, k_1), (c_2, k_2), (c_3, k_3), \dots, (c_n, k_n)$  such that  $c_i > c_{i+1}$  and  $k_i < k_{i+1}$ , for  $i = 1, 2, \dots, n-1$ , then then  $G$  need not be 2-pseudo neighbourly totally irregular intuitionistic fuzzy graph.

**Remark 4.5** Let  $G : (A, B)$  be an intuitionistic fuzzy graph on a cycle  $G^* : (V, E)$  of length  $n$ . If the values of the edges  $e_1, e_2, e_3, \dots, e_n$  are respectively  $(c_1, k_1), (c_2, k_2), (c_3, k_3), \dots, (c_n, k_n)$  are all distinct, then  $G$  need not be 2-pseudo neighbourly irregular intuitionistic fuzzy graph.

## §5. 2-Pseudo Neighbourly Irregular Intuitionistic Fuzzy Graph on a Bi-star $B_{n,m}(m \neq n)$ with Specific Membership Functions

In this section, Theorems 5.1 and 5.6 provide 2-pseudo neighbourly irregularity on intuitionistic fuzzy graph  $G : (A, B)$  on  $G^* : (V, E)$  which is a Bistar  $B_{n,m}(m \neq n)$ .

**Theorem 5.1** *Let  $G : (A, B)$  be an intuitionistic fuzzy graph on  $G^* : (V, E)$  which is a Bi-star  $B_{n,m}(m \neq n)$ . If  $B$  is a constant function, then  $G$  is 2-pseudo neighbourly irregular intuitionistic*

fuzzy graph.

*Proof* Let  $v_1, v_2, v_3, \dots, v_n$  be the vertices adjacent to the vertex  $x$  and  $u_1, u_2, u_3, \dots, u_m$  be the vertices adjacent to the vertex  $y$  and  $xy$  is the middle edge of  $K_2$ . Since  $B$  is a constant function, then  $B(uv) = (c_1, c_2)$ , a constant for all  $uv \in E$ . So,  $d_{(2)}(v_i) = n(c_1, c_2)$ , ( $1 \leq i \leq n-1$ ),  $d_{(2)}(x) = m(c_1, c_2)$ ,  $d_{(2)}(y) = n(c_1, c_2)$  and  $d_{(2)}(u_i) = m(c_1, c_2)$ , ( $1 \leq i \leq m$ ). Then,  $d_{(a)(2)}(v_i) = m(c_1, c_2)$ , ( $1 \leq i \leq n-1$ ),  $d_{(a)(2)}(x) = n(c_1, c_2)$ ,  $d_{(a)(2)}(y) = m(c_1, c_2)$  and  $d_{(a)(2)}(u_i) = n(c_1, c_2)$ , ( $1 \leq i \leq m$ ). Hence  $d_{(a)(2)}(v_i) \neq d_{(a)(2)}(x)$ , ( $1 \leq i \leq n$ ) and  $d_{(a)(2)}(x) \neq d_{(a)(2)}(y)$  and  $d_{(a)(2)}(u_i) \neq d_{(a)(2)}(y)$ , ( $1 \leq i \leq m$ ). Hence  $G$  is 2-pseudo neighbourly irregular intuitionistic fuzzy graph.  $\square$

**Remark 5.2** Even if  $B$  is a constant function, then  $G$  need not be 2-pseudo neighbourly totally irregular intuitionistic fuzzy graph.

**Remark 5.3** Converse of Theorem 5.1 need not be true.

**Theorem 5.4** Let  $G : (A, B)$  be an intuitionistic fuzzy graph on  $G^* : (V, E)$  which is a Bi-star  $B_{n,m}$  ( $m \neq n$ ). If the pendant edges have the same membership values less than or equal to membership value of the middle edge and same non-membership values greater than or equal to non-membership value of the middle edge, then  $G$  is a 2-pseudo neighbourly irregular intuitionistic fuzzy graph.

*Proof* Let  $v_1, v_2, v_3, \dots, v_n$  be the vertices adjacent to the vertex  $x$  and  $u_1, u_2, u_3, \dots, u_m$  be the vertices adjacent to the vertex  $y$  and  $xy$  is the middle edge of  $K_2$ . If the pendant edges have the same membership value then

$$\mu_2(e_i) = \begin{cases} c_1, & \text{if } e_i \text{ is an pendant edge.} \\ c_2, & \text{if } e_i \text{ is an middle edge.} \end{cases} \quad \gamma_2(e_i) = \begin{cases} k_1, & \text{if } e_i \text{ is an pendant edge.} \\ k_2, & \text{if } e_i \text{ is an middle edge.} \end{cases}$$

If  $c_1 = c_2$  and  $k_1 = k_2$  then  $B$  is a constant function. By Theorem 5.1,  $G$  is a 2-pseudo neighbourly irregular intuitionistic fuzzy graph.

If  $c_1 < c_2$ , and  $k_1 > k_2$ , then  $d_{(2)}(v_i) = n(c_1, k_1)$ , ( $1 \leq i \leq n$ ),  $d_{(2)}(x) = m(c_1, k_1)$ ,  $d_{(2)}(y) = n(c_1, k_1)$ , and  $d_{(2)}(u_i) = m(c_1, k_1)$ , ( $1 \leq i \leq m$ ).

Also,  $d_{(a)(2)}(v_i) = m(c_1, k_1)$ , ( $1 \leq i \leq n$ ),  $d_{(a)(2)}(x) = n(c_1, k_1)$ ,  $d_{(a)(2)}(y) = m(c_1, k_1)$ , and  $d_{(a)(2)}(u_i) = n(c_1, k_1)$ , ( $1 \leq i \leq m$ ).

Hence  $d_{(a)(2)}(v_i) \neq d_{(a)(2)}(x)$ , ( $1 \leq i \leq n$ ),  $d_{(a)(2)}(x) \neq d_{(a)(2)}(y)$ ,  $d_{(a)(2)}(u_i) \neq d_{(a)(2)}(y)$ , ( $1 \leq i \leq m$ ) and  $G$  is a 2-pseudo neighbourly irregular intuitionistic fuzzy graph.  $\square$

**Remark 5.5** Even if the pendant edges have the same membership values less than or equal to membership value of the middle edge and same non-membership values greater than or equal to membership value of the middle edge, then  $G$  need not be 2-pseudo neighbourly totally irregular intuitionistic fuzzy graph.

### §6. 2-Pseudo Neighbourly Irregular Intuitionistic Fuzzy Graph on $\text{Sub}(B_{n,m})$ with Specific Membership Functions

In this section, Theorem 6.1 provides a condition for 2-pseudo neighbourly irregularity on intuitionistic fuzzy graph  $G : (A, B)$  on  $G^* : (V, E)$ ,  $\text{Sub}(B_{n,m})$ ,  $n, m \geq 3$ .

**Theorem 6.1** *Let  $G : (A, B)$  be an intuitionistic fuzzy graph on  $G^* : (V, E)$  which is a  $\text{Sub}(B_{n,m})$ ,  $n, m \geq 3$ . If  $B$  is a constant function, then  $G$  is 2-pseudo neighbourly irregular intuitionistic fuzzy graph.*

*Proof* Let  $v_1, v_2, v_3, \dots, v_n$  be the vertices adjacent to the vertex  $x$  and  $u_1, u_2, u_3, \dots, u_m$  be the vertices adjacent to the vertex  $y$  and  $xy$  is the middle edge of  $K_2$ . Subdivide each edge of  $B_{n,m}$ .

Then the additional edges are  $xw_i, w_i v_i$  ( $1 \leq i \leq n$ ) and  $yt_i, t_i u_i$  ( $1 \leq i \leq m$ ) and two more edges  $xs, sy$ .

If  $B$  is a constant function say  $B(uv) = (c_1, c_2)$ , for  $uv \in E$ .

**Case 1.** If  $n \neq m$ , then  $d_{(2)}(v_i) = (c_1, c_2)$ , ( $1 \leq i \leq n$ ),  $d_{(2)}(w_i) = n(c_1, c_2)$ , ( $1 \leq i \leq n$ ),  $d_{(2)}(x) = (n+1)(c_1, c_2)$ ,  $d_{(2)}(s) = (m+n)(c_1, c_2)$ ,  $d_{(2)}(y) = (m+1)(c_1, c_2)$ ,  $d_{(2)}(t_i) = m(c_1, c_2)$ , ( $1 \leq i \leq m$ ), and  $d_{(2)}(u_i) = (c_1, c_2)$ , ( $1 \leq i \leq m$ ).

Hence we have,  $d_{(a)(2)}(v_i) \neq d_{(a)(2)}(w_i)$ , ( $1 \leq i \leq n$ ) and  $d_{(a)(2)}(w_i) \neq d_{(a)(2)}(x)$ , ( $1 \leq i \leq n$ ),  $d_{(a)(2)}(x) \neq d_{(a)(2)}(s)$ ,  $d_{(a)(2)}(s) \neq d_{(a)(2)}(y)$ ,  $d_{(a)(2)}(t_i) \neq d_{(a)(2)}(y)$ , ( $1 \leq i \leq m$ ), and  $d_{(a)(2)}(t_i) \neq d_{(a)(2)}(u_i)$ , ( $1 \leq i \leq m$ ).

Hence  $G$  is a 2-pseudo neighbourly irregular intuitionistic fuzzy graph.

**Case 2.** If  $n = m$ , then  $d_{(2)}(v_i) = (c_1, c_2)$ , ( $1 \leq i \leq n$ ),  $d_{(2)}(w_i) = n(c_1, c_2)$ , ( $1 \leq i \leq n$ ),  $d_{(2)}(x) = (n+1)(c_1, c_2)$ ,  $d_{(2)}(s) = (2n)(c_1, c_2)$ ,  $d_{(2)}(y) = (n+1)(c_1, c_2)$ ,  $d_{(2)}(t_i) = n(c_1, c_2)$ , ( $1 \leq i \leq n$ ), and  $d_{(2)}(u_i) = (c_1, c_2)$ , ( $1 \leq i \leq n$ ).

Hence we have,  $d_{(a)(2)}(v_i) \neq d_{(a)(2)}(w_i)$ , ( $1 \leq i \leq n$ ),  $d_{(a)(2)}(w_i) \neq d_{(a)(2)}(x)$ , ( $1 \leq i \leq n$ ),  $d_{(a)(2)}(x) \neq d_{(a)(2)}(s)$ ,  $d_{(a)(2)}(s) \neq d_{(a)(2)}(y)$ ,  $d_{(a)(2)}(t_i) \neq d_{(a)(2)}(y)$ , ( $1 \leq i \leq m$ ),  $d_{(a)(2)}(t_i) \neq d_{(a)(2)}(u_i)$ , ( $1 \leq i \leq m$ ).

Hence  $G$  is a 2-pseudo neighbourly irregular intuitionistic fuzzy graph.  $\square$

**Remark 6.2** Even if  $B$  is a constant function, then  $G$  need not be 2-pseudo neighbourly totally irregular intuitionistic fuzzy graph.

**Remark 6.3** Converse of the Theorem 6.1 need not be true.

### §7. 2-Pseudo Neighbourly Irregular Intuitionistic Fuzzy Graph on a Path of $n$ Vertices with Specific Membership Functions

In this section, Theorems 7.1 and 7.4 provides a condition for 2-pseudo neighbourly irregularity on intuitionistic fuzzy graph  $G : (A, B)$  on a path  $G^* : (V, E)$  on  $n$  vertices.

**Theorem 7.1** *Let  $G : (A, B)$  be an intuitionistic fuzzy graph on a path  $G^* : (V, E)$  on  $n$  vertices.*

If the membership values of the edges  $e_1, e_2, e_3, \dots, e_{n-1}$  are respectively  $c_1, c_2, c_3, \dots, c_{n-1}$  such that  $c_1 < c_2 < c_3 < \dots < c_{n-1}$ , and non-membership values of the edges  $e_1, e_2, e_3, \dots, e_{n-1}$  are respectively  $k_1, k_2, k_3, \dots, k_{n-1}$  such that  $k_1 > k_2 > k_3 > \dots > k_{n-1}$ , then  $G$  is a 2-pseudo neighbourly irregular intuitionistic fuzzy graph.

*Proof* Let  $G : (A, B)$  be an intuitionistic fuzzy graph on a path  $G^* : (V, E)$  on  $n$  vertices. Let  $e_1, e_2, e_3, \dots, e_{n-1}$  be the edges of the path  $G^*$  in that order. Let membership value of the edges  $e_1, e_2, e_3, \dots, e_{n-1}$  be respectively  $c_1, c_2, c_3, \dots, c_{n-1}$  such that  $c_1 < c_2 < c_3, \dots, < c_{n-1}$  and non-membership values of the edges  $e_1, e_2, e_3, \dots, e_{n-1}$  are respectively  $k_1, k_2, k_3, \dots, k_{n-1}$  such that  $k_1 > k_2 > k_3 > \dots > k_{n-1}$ .

$$d_{(2)}(v_1) = \{(\mu_2(e_1) \wedge \mu_2(e_2), \gamma_2(e_1) \vee \gamma_2(e_2))\} = \{c_1 \wedge c_2, k_1 \vee k_2\} = (c_1, k_1).$$

$$d_{(2)}(v_2) = \{(\mu_2(e_2) \wedge \mu_2(e_3), \gamma_2(e_2) \vee \gamma_3(e_2))\} = \{c_2 \wedge c_3, k_2 \vee k_3\} = (c_2, k_2).$$

For  $3 \leq i \leq n-2$ ,

$$\begin{aligned} d_{(2)}(v_i) &= \{\{\mu_2(e_{i-1}) \wedge \mu_2(e_{i-2})\} + \{\mu_2(e_i) \wedge \mu_2(e_{i+1})\}, \{\gamma_2(e_{i-1}) \wedge \gamma_2(e_{i-2})\} \\ &\quad + \{\gamma_2(e_i) \wedge \gamma_2(e_{i+1})\}\} = (c_{i-2} + c_i, k_{i-2} + k_i). \end{aligned}$$

$$\begin{aligned} d_{(2)}(v_{n-1}) &= \{\mu_2(e_{n-3}) \wedge \mu_2(e_{n-2})\}, \{\gamma_2(e_{n-3}) \wedge \gamma_2(e_{n-2})\} \\ &= \{c_{n-3} \wedge c_{n-2}, k_{n-3} \wedge k_{n-2}\} = (c_{n-3}, k_{n-3}). \end{aligned}$$

$$\begin{aligned} d_{(2)}(v_n) &= \{\mu_2(e_{n-1}) \wedge \mu_2(e_{n-2})\}, \{\gamma_2(e_{n-1}) \wedge \gamma_2(e_{n-2})\} \\ &= \{c_{n-1} \wedge c_{n-2}, k_{n-1} \wedge k_{n-2}\} = (c_{n-2}, k_{n-2}). \end{aligned}$$

So, every two adjacent vertices have distinct  $d_2$ - pseudo degrees. Hence  $G$  is a 2-pseudo neighbourly irregular intuitionistic fuzzy graph.  $\square$

**Remark 7.2** Even if the membership values of the edges  $e_1, e_2, e_3, \dots, e_{n-1}$  are respectively  $c_1, c_2, c_3, \dots, c_{n-1}$  such that  $c_1 < c_2 < c_3 < \dots < c_{n-1}$  and non-membership values of the edges  $e_1, e_2, e_3, \dots, e_{n-1}$  are respectively  $k_1, k_2, k_3, \dots, k_{n-1}$  such that  $k_1 > k_2 > k_3 > \dots > k_{n-1}$ . then  $G$  need not be 2-pseudo neighbourly totally irregular intuitionistic fuzzy graph.

**Theorem 7.3** Let  $G : (A, B)$  be an intuitionistic fuzzy graph on  $G^* : (V, E)$ , a path on  $n$  vertices. If the membership values of the edges  $e_1, e_2, e_3, \dots, e_{n-1}$  are respectively  $c_1, c_2, c_3, \dots, c_{n-1}$  such that  $c_1 > c_2 > c_3 > \dots > c_{n-1}$  and non-membership values of the edges  $e_1, e_2, e_3, \dots, e_{n-1}$  are respectively  $k_1, k_2, k_3, \dots, k_{n-1}$  such that  $k_1 < k_2 < k_3 < \dots < k_{n-1}$ . then  $G$  is a 2-pseudo neighbourly irregular intuitionistic fuzzy graph.

*Proof* Let  $G : (A, B)$  be an intuitionistic fuzzy graph on  $G^* : (V, E)$  is a path on  $n$  vertices. Let  $e_1, e_2, e_3, \dots, e_{n-1}$  be the edges of the path  $G^*$  in that order. Let membership values of the edges  $e_1, e_2, e_3, \dots, e_{n-1}$  are respectively  $c_1, c_2, c_3, \dots, c_{n-1}$  such that  $c_1 > c_2 > c_3 > \dots > c_{n-1}$  and non-membership values of the edges  $e_1, e_2, e_3, \dots, e_{n-1}$  are respectively  $k_1, k_2, k_3, \dots, k_{n-1}$

such that  $k_1 < k_2 < k_3 < \dots < k_{n-1}$ .

$$\begin{aligned} d_{(2)}(v_1) &= \{(\mu_2(e_1) \wedge \mu_2(e_2), \gamma_2(e_1) \wedge \gamma_2(e_2))\} = \{c_1 \wedge c_2, k_1 \vee k_2\} = (c_2, k_2). \\ d_{(2)}(v_2) &= \{(\mu_2(e_2) \wedge \mu_2(e_3), \gamma_2(e_2) \wedge \gamma_2(e_3))\} = \{c_2 \wedge c_3, k_2 \vee k_3\} = (c_3, k_3). \end{aligned}$$

For  $3 \leq i \leq n-2$ ,

$$\begin{aligned} d_{(2)}(v_i) &= \{\mu_2(e_{i-1}) \wedge \mu_2(e_{i-2})\} + \{\mu_2(e_i) \wedge \mu_2(e_{i+1})\} + \{\gamma_2(e_{i-1}) \wedge \gamma_2(e_{i-2})\} \\ &\quad + \{\gamma_2(e_i) \wedge \gamma_2(e_{i+1})\} = (c_{i-1} + c_{i+1}, k_{i-1} + k_{i+1}) \\ d_{(2)}(v_{n-1}) &= \{\mu_2(e_{n-3}) \wedge \mu_2(e_{n-2}), \gamma_2(e_{n-3}) \wedge \gamma_2(e_{n-2})\} = \{c_{n-3} \wedge c_{n-2}, k_{n-3} \wedge k_{n-2}\} \\ &= (c_{n-2}, k_{n-2}). \\ d_{(2)}(v_n) &= \{\mu_2(e_{n-1}) \wedge \mu_2(e_{n-2}), \gamma_2(e_{n-1}) \wedge \gamma_2(e_{n-2})\} = \{c_{n-1} \wedge c_{n-2}, k_{n-1} \wedge k_{n-2}\} \\ &= (c_{n-1}, k_{n-1}). \end{aligned}$$

Every two adjacent vertices have distinct  $d_2$ -pseudo degrees. Hence  $G$  is a 2-pseudo neighbourly irregular intuitionistic fuzzy graph.  $\square$

**Remark 7.4** Even if the membership values of the edges  $e_1, e_2, e_3, \dots, e_{n-1}$  are respectively  $c_1, c_2, c_3, \dots, c_{n-1}$  such that  $c_1 > c_2 > c_3 > \dots > c_{n-1}$  and non-membership values of the edges  $e_1, e_2, e_3, \dots, e_{n-1}$  are respectively  $k_1, k_2, k_3, \dots, k_{n-1}$  such that  $k_1 < k_2 < k_3 < \dots < k_{n-1}$ . then  $G$  need not be 2-pseudo neighbourly totally irregular intuitionistic fuzzy graph.

## References

- [1] Akram. M, Dudek. W, Regular intuitionistic Fuzzy graphs, *Neural Computing and Application*, 1007/s00521-011-0772-6.
- [2] Akram. M, Davvaz. B, Strong intuitionistic Fuzzy graphs, *Filomat* 26:1 (2012),177-196.
- [3] Atanassov. K.T., *Intuitionistic Fuzzy Sets: Theory, Applications*, Studies in fuzziness and soft computing, Heidelberg,New York, Physica-Verl., 1999.
- [4] Atanassov. K.T., Pasi,R.Yager. G, Atanassov. V, Intuitionistic Fuzzy graph interpretations of multi-person multi-criteria decision making, *EUSFLAT Conf.*, 2003,177-182.
- [5] Bhattacharya. P, Some remarks on Fuzzy graphs, *Pattern Recognition Lett*, 6(1987), 297-302.
- [6] John N.Moderson and Premchand S. Nair, *Fuzzy graphs and Fuzzy Hypergraphs* Physica verlag, Heidelberg(2000).
- [7] Karunambigai. M.G., Parvathi. R and Buvanewari. P, Constant intuitionistic Fuzzy graphs, *NIFS*, 17 (2011), 1, 37-47.
- [8] Karunambigai. M.G., Sivasankar. S and Palanivel. K, Some properties of regular intuitionistic Fuzzy graph, *International Journal of Mathematics and Computation*, Vol.26, Issue No.4(2015).
- [9] Kaufmann. A., *Introduction to the Theory of Fuzzy Subsets*, Vol. 1, Academic Press, New York, 1975.



- [10] Nagoor Gani.A and Radha. K, On regular Fuzzy graphs, *Journal of Physical Sciences*, 12(2008) 33-40.
- [11] Nagor Gani. A., Jahir Hussain. R., and Yahya Mohamed. S., Irregular intuitionistic Fuzzy graphs, *IOSR Journal of Mathematics*, Vol.9, No.6(2014), 47-51.
- [12] Parvathi. R and Karunambigai. M.G., Intuitionistic Fuzzy graphs, *Journal of Computational Intelligence: Theory and Applications* (2006), 139-150.
- [13] Ravi Narayanan. S., and Murugesan. S.,  $(2, (c_1, c_2))$ -Pseudo regular intuitionistic Fuzzy graphs, *International Journal of Fuzzy Mathematical Archieve*, Vol.10, No.2, (2016), 131-137.
- [14] Ravi Narayanan. S., and Murugesan. S.,  $((r_1, r_2), 2, (c_1, c_2))$ - *Pseudo Regular Intuitionistic Fuzzy Graphs* (Communicated).
- [15] Rosenfeld. A., Fuzzy graphs, in: L.A. Zadeh and K.S. Fu, M. Shimura(EDs) *Fuzzy sets and their applications*, Academic Press, Newyork 77-95, 1975.
- [16] Zadeh. L.A., fuzzy sets, *Information and Control*, 8 (1965), 338-353.

## A Generalization of the Alexander Polynomial

İsmet Altıntaş

(Faculty of Arts and Sciences, Department of Mathematics, Sakarya University, Sakarya, 54187, Turkey)

Kemal Taşköprü

(Faculty of Arts and Sciences, Department of Mathematics, Bilecik Şeyh Edebali University, Bilecik, 11000, Turkey)

E-mail: ialtintas@sakarya.edu.tr, kemal.taskopru@bilecik.edu.tr

**Abstract:** In this paper, we present a generalization of two variables of the Alexander polynomial for a given oriented knot diagram. We define the Alexander polynomial of two variables by an easy method which will be achieved as a result of the interpretation of the crossing point as a particle with input-output spins in the mathematical physics. The classical Alexander polynomial is the case of one of the variables to be equal to 1 in the Alexander polynomial of two variables.

**Key Words:** Knot polynomials, Alexander polynomial, ambient isotopy.

**AMS(2010):** 57M25, 57M50, 57M10.

### §1. Introduction

A knot polynomial is a knot invariant in the form of a polynomial whose coefficients encode some of the properties of a given knot. The Alexander polynomial is the first knot polynomial. It was introduced by J. W. Alexander in 1928 ([1]).

There are several ways to calculate the Alexander polynomial. One of them is the procedure given by Alexander in his paper [1]. This procedure is briefly as follows: Given an oriented diagram of the knot with  $n$  crossings. There are  $n + 2$  regions bounded by the knot diagram. The Alexander polynomial is calculated by using a matrix of size  $n \times (n + 2)$ . The rows of the matrix correspond to crossings, and the columns to the regions. Another one is to calculate from the Seifert matrix ([2]). The Alexander polynomial can also be calculated by using the free derivative defined by Fox [3,4].

Other knot polynomials were not found until almost 60 years later. In the 1960s, J.Conway came up with a skein relation for a version of the Alexander polynomial, usually referred to as the AlexanderConway polynomial [5]. The significance of this skein relation was not realized until the early 1980s, when V. Jones discovered the Jones polynomial [6,7]. This led to the discovery of more knot polynomials, such as the so-called Homfly polynomial [8]. The Homfly polynomial is a generalization of the AlexanderConway polynomial and the Jones polynomial. Soon after Jones' discovery, Louis Kauffman noticed the Jones polynomial could be computed

---

<sup>1</sup>Received February 24, 2016, Accepted November 5, 2016.

by means of a state-sum model, which involved the bracket polynomial, an invariant of framed knots [9-13]. This opened up avenues of research linking knot theory and statistical mechanics.

In recent years, the Alexander polynomial has been shown to be related to Floer homology. The graded Euler characteristic of the knot Floer homology of Ozsváth and Szabó is the Alexander polynomial [14,15].

In this paper, we work on a generalization of two variables of the Alexander polynomial. We define the Alexander polynomial of two variables by an easy method. In the method, the Alexander polynomial of two variables is calculated by using a matrix of size  $n \times n$ . The rows of the matrix correspond to crossings of the oriented diagram of the knot with  $n$  crossings, and the columns to the arcs. The classical Alexander polynomial is the case of one of the variables to be equal to 1 in the Alexander polynomial of two variables.

**§2. Alexander Polynomial of Two Variables**

A link  $K$  of  $k$  components is a subset of  $\mathbb{R}^3 \subset \mathbb{R}^3 \cup \{\infty\} = S^3$ , consisting of  $k$  disjoint piecewise simple closed curves; a knot is a link with one component. In fact, two knots (or links) in  $\mathbb{R}^3$  can be deformed continuously one into the other if and only if any diagram of one knot can be transformed into a diagram for the knot via a sequence of the Reidmeister moves formed in Figure 1. The equivalence relation on diagrams that is generated by all the Reidmeister moves is called ambient isotopy. In the study, the word knot will be used instead knot and link.

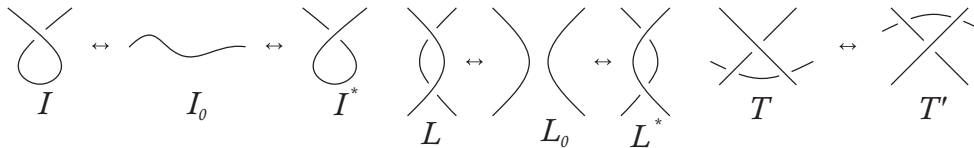

**Figure 1**

The first Reidmeister move:  $I \leftrightarrow I_0$  or  $I^* \leftrightarrow I_0$ ; The second Reidmeister move:  $L \leftrightarrow L_0$  or  $L^* \leftrightarrow L_0$  and the third Reidmeister move:  $T \leftrightarrow T'$ .

Let  $K$  be an oriented knot diagram with  $n$  crossings. Three arcs of the curve of the oriented diagram  $K$  encounters at a crossing. One of these arcs is overpass arc and the other two are underpass arcs that follow one another at the crossing point. Let  $c_i$  denote the  $i$ th crossing of the oriented diagram  $K$ ,  $i = 1, 2, \dots, n$ . We assume that the arcs  $s_i, s_j$  and  $s_k$  are encounter at the crossing  $c_i$ , see Figure 2.

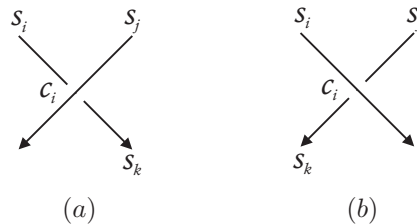

**Figure 2** Crossings with positive sign (a) and negative sign (b)

In mathematical physics if we interpret the crossing point as a particle with incoming spins  $s_i, s_j$  and outgoing spins  $s_j, s_k$  for the crossing in Figure 2a, then an associated mathematical expression to the crossing point can be regarded as the probability amplitude for this particular combination of spins in and out [13]. We can make a similar comment for the crossing in Figure 2b, For now it is convenient to consider only the spins. The conservation of spin suggests the rule that

$$s_i + s_j = s_j + s_k.$$

If  $x$  and  $y$  are algebraic variables, then

$$xs_i + ys_j - xs_j - ys_k = xs_i + (y - x)s_j - ys_k = 0$$

is a assigned equation to the crossing in Figure 2a. With the same thought, we can assign an equation to the crossing in Figure B. We say the above equation, the crossing equation.

By assigning a crossing equation for each crossing of the oriented diagram  $K$  we have a homogeneous system of  $n$  equations in  $n$  unknowns, and call diagram equation.

Since there are three unknowns (arcs) in a crossing equation, we get zero the coefficient of  $(n - 3)$  arcs that are not in this crossing equation. Thus, we obtain a coefficients matrix  $\mathbf{M}$  of size  $n \times n$  of the diagram equation. It is easy to see that the determinant,  $|\mathbf{M}|$ , of the coefficients matrix  $\mathbf{M}$  is zero.

We may then regarded the matrix  $\mathbf{M}$  as having entries in the ring  $\mathbb{Z}[x, x^{-1}, y, y^{-1}]$  along with its subring  $\mathbb{Z}[x, y]$  has the property that any finite set of elements has a greatest common divider. Any integer domain with these properties is called a greatest common divider. Determinants of the minors of size  $(n - 1) \times (n - 1)$  of the matrix  $\mathbf{M}$  are equal with multiplying  $\mp x^k y^l, k, l \in \mathbb{Z}$  that has the greatest common divider.

**Definition 2.1** *We will call the Alexander polynomial of two variables that is the greatest common divider of determinants of minors of size  $(n - 1) \times (n - 1)$  of the matrix  $\mathbf{M}$  and we'll denote it by  $\nabla(x, y)$ .*

If  $\nabla_{K_1}(x, y)$  and  $\nabla_{K_2}(x, y)$  are polynomials that are equal with such a factor, we write  $\nabla_{K_1}(x, y) \doteq \nabla_{K_2}(x, y)$ . Any one of the minors of size  $(n - 1) \times (n - 1)$  of  $\mathbf{M}$  can be taken to be a presentation matrix for  $\nabla(x, y)$  and its determinant can be taken to be  $\nabla(x, y)$  with multiplying by  $\mp x^k y^l, k, l \in \mathbb{Z}$ , see [4,16].

**Example 2.2** We now calculate the Alexander polynomial of two variables of the trefoil knot as an example. Let  $K$  be the right-hand diagram trefoil knot drawn in Figure 3. The diagram equation of the knot  $K$  is as follows:

$$\begin{aligned} xs_3 + ys_2 - xs_2 - ys_1 &= -ys_1 + (y - x)s_2 + xs_3 = 0 \\ xs_2 + ys_1 - xs_1 - ys_3 &= (y - x)s_1 + xs_2 - ys_3 = 0 \\ xs_1 + ys_3 - xs_3 - ys_2 &= xs_1 - ys_2 + (y - x)s_3 = 0 \end{aligned}$$

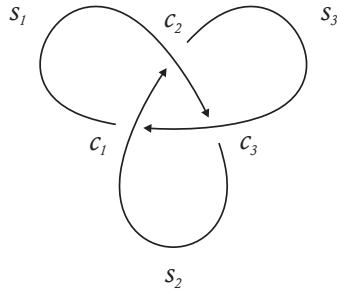

**Figure 3** The right-hand trefoil knot.

The coefficients matrix  $\mathbf{M}_K$  of size  $3 \times 3$  of this diagram equation is

$$\mathbf{M}_K = \begin{bmatrix} -y & y - x & x \\ y - x & x & -y \\ x & -y & y - x \end{bmatrix}.$$

The determinant,  $|\mathbf{M}_k|$  of the coefficients matrix  $\mathbf{M}_K$  is zero. Hence, any one of the minors of size  $2 \times 2$  of the matrix  $\mathbf{M}_K$ , for instance,  $\nabla_{11}$  is a presentation matrix and its determinant is  $|\nabla_{11}| = -x^2 + xy - y^2$ . Thus, the Alexander polynomial of two variables for the knot  $K$ ;  $\nabla_K(x, y) = x^2 - xy + y^2$ .

We have  $\nabla_K(x, 1) = x^2 - x + 1$  for  $y = 1$  (or  $\nabla_K(1, y) = 1 - y + y^2$  for  $x = 1$ ). It is the classical Alexander polynomial of the trefoil knot.

The following theorem gives that the Alexander polynomial of two variables is an invariant of the knot.

**Theorem 2.3** *If  $K$  is an oriented knot diagram, then the Alexander polynomial of two variables,  $\nabla_K(x, y)$ , of the knot  $K$  is an invariant of ambient isotopy.*

*Proof* In order to prove that the Alexander polynomial is an invariant of ambient isotopy, we must investigate the behavior of  $\nabla_K(x, y)$  under the Reidemeister moves given in Figure 1. Here, we shall investigate the behavior of  $\nabla_K(x, y)$  under the diagrams given in Figure 4.

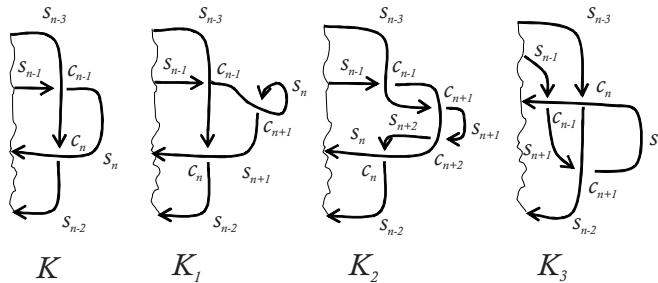

**Figure 4**

Diagrams for the proof of Theorem 2.3. For the first Reidemeister move:  $K \leftrightarrow K_1$ ; for the second Reidemeister move:  $K \leftrightarrow K_2$ ; for the third Reidemeister move:  $K \leftrightarrow K_3$ .

Let  $K$  be the oriented knot diagram with  $n$  crossings given in Figure 4. The diagram equation of the knot  $K$  is as follows:

$$\begin{array}{ccccccc} \dots & & & \dots & & & \dots \\ xs_{n-1} + ys_{n-3} - xs_{n-3} - ys_n & = & (y-x)s_{n-3} + xs_{n-1} - ys_n & = & 0 \\ xs_{n-3} + ys_n - xs_n - ys_{n-2} & = & xs_{n-3} - ys_{n-2} + (y-x)s_n & = & 0 \end{array}$$

The coefficients matrix  $\mathbf{M}_K$  of size  $n \times n$  of this diagram equation is

$$\mathbf{M}_K = \begin{bmatrix} \vdots & \vdots & \vdots & \vdots & \vdots \\ \dots & y-x & 0 & x & -y \\ \dots & x & -y & 0 & y-x \end{bmatrix}.$$

Thus, any one of the minors of size  $(n-1) \times (n-1)$  of the matrix  $\mathbf{M}_K$ , for instance,  $\nabla_{11}$  is a presentation matrix and its determinant  $|\nabla_{11}| = \nabla_K(x, y)$  with multiplying by  $\mp x^k y^l$ ,  $k, l \in \mathbb{Z}$ .

### Case 1. The behavior of $\nabla_K(x, y)$ under the first Reidemeister move

The diagram equation of the diagram  $K_1$  with  $(n+1)$  crossings given in Figure 4 is as follows:

$$\begin{array}{ccccccc} \dots & & & \dots & & & \dots \\ xs_{n-1} + ys_{n-3} - xs_{n-3} - ys_n & = & (y-x)s_{n-3} + xs_{n-1} - ys_n & = & 0 \\ xs_{n-3} + ys_{n+1} - xs_{n+1} - ys_{n-2} & = & xs_{n-3} - ys_{n-2} + (y-x)s_{n+1} & = & 0 \\ xs_n + ys_n - xs_{n+1} - ys_n & = & xs_n - xs_{n+1} & = & 0 \end{array}$$

Hence, we have the following coefficients matrix  $\mathbf{M}_{K_1}$  of size  $(n-1) \times (n-1)$  of the diagram equation.

$$\begin{aligned} \mathbf{M}_{K_1} &= \begin{bmatrix} \vdots & \vdots & \vdots & \vdots & \vdots & \vdots \\ \dots & y-x & 0 & x & -y & 0 \\ \dots & x & -y & 0 & 0 & y-x \\ \dots & 0 & 0 & 0 & x & -x \end{bmatrix} \\ &= \begin{bmatrix} \vdots & \vdots & \vdots & \vdots & \vdots & \vdots \\ \dots & y-x & 0 & x & -y & 0 \\ \dots & x & -y & 0 & y-x & y-x \\ \dots & 0 & 0 & 0 & 0 & -x \end{bmatrix}. \end{aligned}$$

Since  $|\mathbf{M}_{K_1}| = -x|\mathbf{M}_K| = 0$ , the minors of size  $(n-1) \times (n-1)$  of  $\mathbf{M}_{K_1}$  are equal the corresponding minors size  $(n-1) \times (n-1)$  of  $\mathbf{M}_K$  and hence,  $\nabla_K(x, y) \doteq \nabla_{K_1}(x, y)$ . In that

case  $\nabla_K(x, y)$  is unchanged under the first Reidemeister move.

**Case 2. The behavior of  $\nabla_K(x, y)$  under the second Reidemeister move**

We obtain the following diagram equation from the diagram  $K_2$  with  $(n + 2)$  crossings given in Figure 4.

$$\begin{array}{rcl}
 \dots & & \dots & & \dots \\
 xs_{n-1} + ys_{n-3} - xs_{n-3} - ys_n & = & (y-x)s_{n-3} + xs_{n-1} - ys_n & = & 0 \\
 xs_{n-3} + ys_n - xs_n - ys_{n-2} & = & xs_{n-3} - ys_{n-2} + (y-x)s_n & = & 0 \\
 xs_n + ys_{n-2} - xs_{n+1} - ys_n & = & ys_{n-2} + (x-y)s_n - xs_{n+1} & = & 0 \\
 xs_{n+1} + ys_n - xs_n - ys_{n+2} & = & (y-x)s_n + xs_{n+1} - ys_{n+2} & = & 0
 \end{array}$$

The coefficients matrix  $\mathbf{M}_{K_2}$  of size  $(n + 2) \times (n + 2)$  of the diagram equation of  $K_2$  here is as follows.

$$\mathbf{M}_{K_2} = \begin{bmatrix} \vdots & \vdots & \vdots & \vdots & \vdots & \vdots & \vdots \\ \dots & y-x & 0 & x & -y & 0 & 0 \\ \dots & x & -y & 0 & y-x & 0 & 0 \\ \dots & 0 & y & 0 & x-y & -x & 0 \\ \dots & 0 & 0 & 0 & y-x & x & -y \end{bmatrix} \\
 = \begin{bmatrix} \vdots & \vdots & \vdots & \vdots & \vdots & \vdots & \vdots \\ \dots & y-x & 0 & x & -y & 0 & 0 \\ \dots & x & -y & 0 & y-x & 0 & 0 \\ \dots & 0 & y & 0 & x-y & -x & 0 \\ \dots & 0 & y & 0 & 0 & 0 & -y \end{bmatrix}.$$

Since  $|\mathbf{M}_{K_2}| = xy|\mathbf{M}_K| = 0$ , the minors of size  $(n - 1) \times (n - 1)$  of  $\mathbf{M}_{K_2}$  are equal the corresponding minors size  $(n - 1) \times (n - 1)$  of  $\mathbf{M}_K$  and  $\nabla_K(x, y) \doteq \nabla_{K_2}(x, y)$ . Thus  $\nabla_K(x, y)$  is unchanged under the second Reidemeister move.

**Case 3. The behavior of  $\nabla_K(x, y)$  under the third Reidemeister move**

We have the following diagram equation from the diagram  $K_3$  with  $(n + 1)$  crossings given in Figure 4.

$$\begin{array}{rcl}
 \dots & & \dots & & \dots \\
 xs_{n-1} + ys_n - xs_n - ys_{n+1} & = & xs_{n-1} + (y-x)s_n - ys_{n+1} & = & 0 \\
 xs_{n-3} + ys_n - xs_n - ys_{n-2} & = & xs_{n-3} - ys_{n-2} + (y-x)s_n & = & 0 \\
 xs_{n+1} + ys_{n-2} - xs_{n-2} - ys_n & = & (y-x)s_{n-2} - ys_n + xs_{n+1} & = & 0
 \end{array}$$

The coefficients matrix  $\mathbf{M}_{K_3}$  of size  $(n + 1) \times (n + 1)$  of the diagram equation of  $K_3$  here

is as follows.

$$\mathbf{M}_{K_3} = \begin{bmatrix} \vdots & \vdots & \vdots & \vdots & \vdots & \vdots \\ \dots & 0 & 0 & x & y-x & -y \\ \dots & x & -y & 0 & y-x & 0 \\ \dots & 0 & y-x & 0 & -y & x \end{bmatrix}$$

$$= \begin{bmatrix} \vdots & \vdots & \vdots & \vdots & \vdots & \vdots \\ \dots & y-x & 0 & x & -y & x-y \\ \dots & x & -y & 0 & y-x & 0 \\ \dots & 0 & 0 & 0 & 0 & x \end{bmatrix}.$$

Since  $|\mathbf{M}_{K_3}| = x|\mathbf{M}_K| = 0$ , the minors of size  $(n-1) \times (n-1)$  of  $\mathbf{M}_{K_3}$  are equal the corresponding minors size  $(n-1) \times (n-1)$  of  $\mathbf{M}_K$  and  $\nabla_K(x, y) \doteq \nabla_{K_3}(x, y)$ . So  $\nabla_K(x, y)$  is unchanged under the third Reidemeister move. Thus proof is completed.  $\square$

It is easy to see that, in present of the first and the second Reidemeister moves, the diagram  $K_3$  in Figure 4 is equivalent to the third Reidemeister move, see Figure 5.

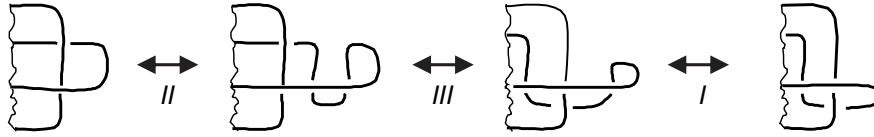

**Figure 5** Equivalence of  $K$  to  $K_3$  under the third Reidemeister move.

There are different variants, depending on orientation, of the diagrams in Figure 4. Theorem 2.1 can also be proved in the same way for these variants of the diagrams. All possible variants of the diagrams used in the proof of Theorem 2.1 is drawn in Appendix.

### Appendix

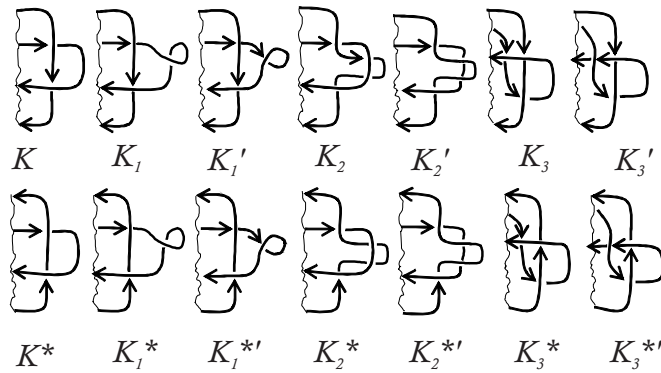

**Figure 6**



## References

- [1] J.W. Alexander, Topological invariants of knots and links, *Trans. Amer. Math. Soc.*, Vol:30, No.2, (1928), 275-306.
- [2] K. Murasugi, *Knot Theory and its Applications*, translated by Kurpito, B., Birkhause, Boston, 1996.
- [3] R.H. Fox, Free differential calculus I: Derivation in the free group ring, *Ann. of Math. Ser. 2.*, Vol:57, No.3, (1953), 547-560.
- [4] R.H. Crowell and R.H. Fox, *Introduction to Knot Theory*, Graduate Texts in Mathematics 57 Springer-Verlag, 1977.
- [5] W.B. Lickorish, *Raymond An Introduction to Knot Theory*, Graduate Texts in Mathematics, Springer-Verlag, 1997.
- [6] V.F.R. Jones, A new knot polynomial and Von Neuman algebras, *Notices. Amer. Math. Soc.*, Vol:33, No.2, (1986), 219-225.
- [7] V.F.R. Jones, Hecke algebra representations of braid groups and link polynomial, *Ann. Math.*, Vol:126, No.2, (1987), 335-388.
- [8] P. Freyd, D. Yetter, J. Hoste, W.B. Lickorish and A. Ocneau, A new polynomial invariant of knots and links, *Bul. Amer. Math. Soc.*, Vol:12, No.2, (1985), 239-246.
- [9] L.H. Kauffman, State models and the Jones polynomial, *Topology*, Vol:26, No.3, (1987), 395-407.
- [10] L.H. Kauffman, New invariants in the theory of knots, *Amer. Math. Monthly*, Vol:95, No.3, (1988), 195-242.
- [11] L.H. Kauffman, An invariant of regular isotopy, *Trans. Amer. Math. Soc.*, Vol:318, (1990), 417-471.
- [12] L.H. Kauffman, *On Knots*, Princeton University Press, Princeton, New Jersey, 1987.
- [13] L.H. Kauffman, *Knot and Physics*, World Scientific, 1991, (second edition 1993).
- [14] P. Ozvath and Z. Szabo, Heegard Floer homology and alternating knots, *Geometry and Topology*, Vol:7, (2003), 225-254.
- [15] P. Ozvath and Z. Szabo, Holomorphic disks and knot invariants, *Advances in Mathematics*, Vol:186, No.1, (2004), 58-116.
- [16] D. Rolfsen, *Knots and Links*, Publish or Perish, Berkeley, CA, 1976.

## Smarandache Curves of a Spacelike Curve According to the Bishop Frame of Type-2

Yasin Ünlütürk

Department of Mathematics, Kırklareli University, 39100 Kırklareli, Turkey

Süha Yılmaz

Dokuz Eylül University, Buca Faculty of Education

Department of Elementary Mathematics Education, 35150, Buca-Izmir, Turkey

E-mail: yasinunluturk@klu.edu.tr, suha.yilmaz@deu.edu.tr

**Abstract:** In this study, we introduce new Smarandache curves of a spacelike curve according to the Bishop frame of type-2 in  $E_1^3$ . Also, Smarandache breadth curves are defined according to this frame in Minkowski 3-space. A third order vectorial differential equation of position vector of Smarandache breadth curves has been obtained in Minkowski 3-space.

**Key Words:** Smarandache curves, the Bishop frame of type-2, Smarandache breadth curves, Minkowski 3-space.

**AMS(2010):** 53A05, 53B25, 53B30

### §1. Introduction

Bishop frame extended to study canal and tubular surfaces [1]. Rotating camera orientations relative to a stable forward-facing frame can be added by various techniques such as that of Hanson and Ma [2]. This special frame also extended to height functions on a space curve [3].

The construction of the Bishop frame is due to L. R. Bishop and the advantages of Bishop frame, and comparisons of Bishop frame with the Frenet frame in Euclidean 3-space were given by Bishop [4] and Hanson [5]. That is why he defined this frame that curvature may vanish at some points on the curve. That is, second derivative of the curve may be zero. In this situation, an alternative frame is needed for non continuously differentiable curves on which Bishop (parallel transport frame) frame is well defined and constructed in Euclidean and its ambient spaces [6,7,8].

A regular curve in Euclidean 3-space, whose position vector is composed of Frenet frame vectors on another regular curve, is called a Smarandache curve. M. Turgut and S. Yılmaz have defined a special case of such curves and call it Smarandache  $TB_2$  curves in the space  $E_1^4$  ([9]) and Turgut also studied Smarandache breadth of pseudo null curves in  $E_1^4$  ([10]). A.T.Ali has introduced some special Smarandache curves in the Euclidean space [11]. Moreover, special

---

<sup>1</sup>Received April 3, 2016, Accepted November 6, 2016.

Smarandache curves have been investigated by using Bishop frame in Euclidean space [12]. Special Smarandache curves according to Sabban frame have been studied by [13]. Besides, some special Smarandache curves have been obtained in  $E_1^3$  by [14].

Curves of constant breadth were introduced by L.Euler [15]. Some geometric properties of plane curves of constant breadth were given in [16]. And, in another work [17], these properties were studied in the Euclidean 3-space  $E^3$ . Moreover, M Fujivara [18] had obtained a problem to determine whether there exist space curve of constant breadth or not, and he defined breadth for space curves on a surface of constant breadth. In [19], these kind curves were studied in four dimensional Euclidean space  $E^4$ . In [20], Yılmaz introduced a new version of Bishop frame in  $E_1^3$  and called it *Bishop frame of type-2* of regular curves by using common vector field as the binormal vector of Serret-Frenet frame. Also, some characterizations of spacelike curves were given according to the same frame by Yılmaz and Ünlütürk [21]. A regular curve more than 2 breadths in Minkowski 3-space is called a Smarandache breadth curve. In the light of this definition, we study special cases of Smarandache curves according to the new frame in  $E_1^3$ . We investigate position vector of simple closed spacelike curves and give some characterizations in case of constant breadth according to type-2 Bishop frame in  $E_1^3$ . Thus, we extend this classical topic in  $E^3$  into spacelike curves of constant breadth in  $E_1^3$ , see [22] for details.

In this study, we introduce new Smarandache curves of a spacelike curve according to the Bishop frame of type-2 in  $E_1^3$ . Also, Smarandache breadth curves are defined according to this frame in Minkowski 3-space. A third order vectorial differential equation of position vector of Smarandache breadth curves has been obtained in Minkowski 3-space.

## §2. Preliminaries

To meet the requirements in the next sections, here, the basic elements of the theory of curves in the Minkowski 3-space  $E_1^3$  are briefly presented. There exists a vast literature on the subject including several monographs, for example [23,24].

The three dimensional Minkowski space  $E_1^3$  is a real vector space  $R^3$  endowed with the standard flat Lorentzian metric given by

$$\langle , \rangle_L = -dx_1^2 + dx_2^2 + dx_3^2,$$

where  $(x_1, x_2, x_3)$  is a rectangular coordinate system of  $E_1^3$ . This metric is an indefinite one.

Let  $u = (u_1, u_2, u_3)$  and  $v = (v_1, v_2, v_3)$  be arbitrary vectors in  $E_1^3$ , the Lorentzian cross product of  $u$  and  $v$  is defined as

$$u \times v = -\det \begin{bmatrix} -i & j & k \\ u_1 & u_2 & u_3 \\ v_1 & v_2 & v_3 \end{bmatrix}.$$

Recall that a vector  $v \in E_1^3$  has one of three Lorentzian characters: it is a spacelike vector if  $\langle v, v \rangle > 0$  or  $v = 0$ ; timelike  $\langle v, v \rangle < 0$  and null (lightlike)  $\langle v, v \rangle = 0$  for  $v \neq 0$ . Similarly, an

arbitrary curve  $\delta = \delta(s)$  in  $E_1^3$  can locally be spacelike, timelike or null (lightlike) if its velocity vector  $\alpha'$  are ,respectively, spacelike, timelike or null (lightlike), for every  $s \in I \subset \mathbb{R}$ . The pseudo-norm of an arbitrary vector  $a \in E_1^3$  is given by  $\|a\| = \sqrt{|\langle a, a \rangle|}$ . The curve  $\alpha = \alpha(s)$  is called a unit speed curve if its velocity vector  $\alpha'$  is unit one i.e.,  $\|\alpha'\| = 1$ . For vectors  $v, w \in E_1^3$ , they are said to be orthogonal each other if and only if  $\langle v, w \rangle = 0$ . Denote by  $\{T, N, B\}$  the moving Serret-Frenet frame along the curve  $\alpha = \alpha(s)$  in the space  $E_1^3$ .

For an arbitrary spacelike curve  $\alpha = \alpha(s)$  in  $E_1^3$ , the Serret-Frenet formulae are given as follows

$$\begin{bmatrix} T' \\ N' \\ B' \end{bmatrix} = \begin{bmatrix} 0 & \kappa & 0 \\ \gamma\kappa & 0 & \tau \\ 0 & \tau & 0 \end{bmatrix} \cdot \begin{bmatrix} T \\ N \\ B \end{bmatrix}, \quad (2.1)$$

where  $\gamma = \mp 1$ , and the functions  $\kappa$  and  $\tau$  are, respectively, the first and second (torsion) curvature.  $T(s) = \alpha'(s), N(s) = \frac{T'(s)}{\kappa(s)}, B(s) = T(s) \times N(s)$  and  $\tau(s) = \frac{\det(\alpha', \alpha'', \alpha''')}{\kappa^2(s)}$ .

If  $\gamma = -1$ , then  $\alpha(s)$  is a spacelike curve with spacelike principal normal  $N$  and timelike binormal  $B$ , its Serret-Frenet invariants are given as

$$\kappa(s) = \sqrt{\langle T'(s), T'(s) \rangle} \text{ and } \tau(s) = -\langle N'(s), B(s) \rangle.$$

If  $\gamma = 1$ , then  $\alpha(s)$  is a spacelike curve with timelike principal normal  $N$  and spacelike binormal  $B$ , also we obtain its Serret-Frenet invariants as

$$\kappa(s) = \sqrt{-\langle T'(s), T'(s) \rangle} \text{ and } \tau(s) = \langle N'(s), B(s) \rangle.$$

The Lorentzian sphere  $S_1^2$  of radius  $r > 0$  and with the center in the origin of the space  $E_1^3$  is defined by

$$S_1^2(r) = \{p = (p_1, p_2, p_3) \in E_1^3 : \langle p, p \rangle = r^2\}.$$

**Theorem 2.1** *Let  $\alpha = \alpha(s)$  be a spacelike unit speed curve with a spacelike principal normal. If  $\{\Omega_1, \Omega_2, B\}$  is an adapted frame, then we have*

$$\begin{bmatrix} \Omega'_1 \\ \Omega'_2 \\ B' \end{bmatrix} = \begin{bmatrix} 0 & 0 & \xi_1 \\ 0 & 0 & -\xi_2 \\ -\xi_1 & -\xi_2 & 0 \end{bmatrix} \cdot \begin{bmatrix} \Omega_1 \\ \Omega_2 \\ B \end{bmatrix} \quad (2.2)$$

**Theorem 2.2** *Let  $\{T, N, B\}$  and  $\{\Omega_1, \Omega_2, B\}$  be Frenet and Bishop frames, respectively. There exists a relation between them as*

$$\begin{bmatrix} T \\ N \\ B \end{bmatrix} = \begin{bmatrix} \sinh \theta(s) & \cosh \theta(s) & 0 \\ \cosh \theta(s) & \sinh \theta(s) & 0 \\ 0 & 0 & 1 \end{bmatrix} \cdot \begin{bmatrix} \Omega_1 \\ \Omega_2 \\ B \end{bmatrix}, \quad (2.3)$$

where  $\theta$  is the angle between the vectors  $N$  and  $\Omega_1$ .

$$\xi_1 = \tau(s) \cosh \theta(s), \xi_2 = \tau(s) \sinh \theta(s).$$

The frame  $\{\Omega_1, \Omega_2, B\}$  is properly oriented, and  $\tau$  and  $\theta(s) = \int_0^s \kappa(s) ds$  are polar coordinates for the curve  $\alpha = \alpha(s)$ . We shall call the set  $\{\Omega_1, \Omega_2, B, \xi_1, \xi_2\}$  as type-2 Bishop invariants of the curve  $\alpha = \alpha(s)$  in  $E_1^3$ .

### §3. Smarandache Curves of a Spacelike Curve

In this section, we will characterize all types of Smarandache curves of spacelike curve  $\alpha = \alpha(s)$  according to type-2 Bishop frame in Minkowski 3-space  $E_1^3$ .

#### 3.1 $\Omega_1\Omega_2$ -Smarandache Curves

**Definition 3.1** Let  $\alpha = \alpha(s)$  be a unit speed regular curve in  $E_1^3$  and  $\{\Omega_1^\alpha, \Omega_2^\alpha, B_\alpha\}$  be its moving Bishop frame.  $\Omega_1^\alpha\Omega_2^\alpha$ -Smarandache curves are defined by

$$\beta(s^*) = \frac{1}{\sqrt{2}}(\Omega_1^\alpha + \Omega_2^\alpha). \quad (3.1)$$

Now we can investigate Bishop invariants of  $\Omega_1^\alpha\Omega_2^\alpha$ -Smarandache curves of the curve  $\alpha = \alpha(s)$ . Differentiating (3.1) with respect to  $s$  gives

$$\dot{\beta} = \frac{d\beta}{ds} \cdot \frac{ds^*}{ds} = \frac{1}{\sqrt{2}}(\xi_1^\alpha - \xi_2^\alpha)B_\alpha, \quad (3.2)$$

and

$$T_\beta \cdot \frac{ds^*}{ds} = \frac{1}{\sqrt{2}}(\xi_1^\alpha - \xi_2^\alpha)B_\alpha,$$

where

$$\frac{ds^*}{ds} = \frac{1}{\sqrt{2}}|\xi_1^\alpha - \xi_2^\alpha|. \quad (3.3)$$

The tangent vector of the curve  $\beta$  can be written as follows

$$T_\beta = \beta_\alpha. \quad (3.4)$$

Differentiating (3.4) with respect to  $s$ , we obtain

$$\frac{dT_\beta}{ds^*} \cdot \frac{ds^*}{ds} = -(\xi_1^\alpha \Omega_1^\alpha + \xi_2^\alpha \Omega_2^\alpha). \quad (3.5)$$

Substituting (3.3) into (3.5) gives

$$T'_\beta = -\frac{\sqrt{2}}{|\xi_1^\alpha - \xi_2^\alpha|}(\xi_1^\alpha \Omega_1^\alpha + \xi_2^\alpha \Omega_2^\alpha).$$

Then the first curvature and the principal normal vector field of  $\beta$  are, respectively, computed as

$$\|T'_\beta\| = \kappa_\beta = \frac{\sqrt{2}}{|\xi_1^\alpha - \xi_2^\alpha|} \sqrt{-(\xi_1^\alpha)^2 + (\xi_2^\alpha)^2},$$

and

$$N_\beta = \frac{-1}{\sqrt{-(\xi_1^\alpha)^2 + (\xi_2^\alpha)^2}} (\xi_1^\alpha \Omega_1^\alpha + \xi_2^\alpha \Omega_2^\alpha).$$

On the other hand, we express

$$B_\beta = \frac{-1}{\sqrt{-(\xi_1^\alpha)^2 + (\xi_2^\alpha)^2}} \begin{vmatrix} -\Omega_1^\alpha & \Omega_2^\alpha & \beta_\alpha \\ 0 & 0 & 1 \\ \xi_1^\alpha & \xi_2^\alpha & 0 \end{vmatrix},$$

So the binormal vector of  $\beta$  is computed as follows

$$B_\beta = \frac{-1}{\sqrt{-(\xi_1^\alpha)^2 + (\xi_2^\alpha)^2}} (\xi_2^\alpha \Omega_1^\alpha + \xi_1^\alpha \Omega_2^\alpha).$$

Differentiating (3.2) with respect to  $s$  in order to calculate the torsion of the curve  $\beta$ , we obtain

$$\ddot{\beta} = \frac{1}{\sqrt{2}} [-(\xi_1^\alpha + \xi_2^\alpha) \xi_1^\alpha \Omega_1^\alpha - (\xi_1^\alpha + \xi_2^\alpha) \xi_2^\alpha \Omega_2^\alpha + (\dot{\xi}_1^\alpha + \dot{\xi}_2^\alpha) B_\alpha],$$

and similarly

$$\begin{aligned} \ddot{\beta} &= \frac{1}{\sqrt{2}} [(-3\xi_1^\alpha \dot{\xi}_1^\alpha - 2\xi_1^\alpha \dot{\xi}_2^\alpha - \dot{\xi}_1^\alpha \xi_2^\alpha - \xi_1^\alpha \dot{\xi}_1^\alpha) \Omega_1^\alpha \\ &\quad + (-2\dot{\xi}_1^\alpha \xi_2^\alpha - 2(\dot{\xi}_2^\alpha)^2 - \xi_1^\alpha \dot{\xi}_2^\alpha - \xi_2^\alpha \dot{\xi}_2^\alpha) \Omega_2^\alpha \\ &\quad + (\ddot{\xi}_1^\alpha + \ddot{\xi}_2^\alpha - (\xi_1^\alpha)^3 - (\xi_1^\alpha)^2 \xi_2^\alpha - \xi_1^\alpha (\xi_2^\alpha)^2 + (\xi_2^\alpha)^2) B_\alpha]. \end{aligned}$$

The torsion of the curve  $\beta$  is found

$$\tau_\beta = \frac{1}{4\sqrt{2}} \frac{(\xi_1^\alpha - \xi_2^\alpha)^2}{(\xi_1^\alpha)^2 + (\xi_2^\alpha)^2} [(\xi_1^\alpha + \xi_2^\alpha) K_2(s) - (\xi_1^\alpha + \xi_2^\alpha) \xi_2^\alpha K_1(s)],$$

where

$$\begin{aligned} K_1(s) &= -3\xi_1^\alpha \dot{\xi}_1^\alpha - 2\xi_1^\alpha \dot{\xi}_2^\alpha - \dot{\xi}_1^\alpha \xi_2^\alpha - \xi_1^\alpha \dot{\xi}_1^\alpha, \\ K_2(s) &= -2\dot{\xi}_1^\alpha \xi_2^\alpha - 2(\dot{\xi}_2^\alpha)^2 - \xi_1^\alpha \dot{\xi}_2^\alpha - \xi_2^\alpha \dot{\xi}_2^\alpha, \\ K_3(s) &= \ddot{\xi}_1^\alpha + \ddot{\xi}_2^\alpha - (\xi_1^\alpha)^3 - (\xi_1^\alpha)^2 \xi_2^\alpha - \xi_1^\alpha (\xi_2^\alpha)^2 + (\xi_2^\alpha)^2. \end{aligned}$$

### 3.2 $\Omega_1 B$ -Smarandache Curves

**Definition 3.2** Let  $\alpha = \alpha(s)$  be a unit speed regular curve in  $E_1^3$  and  $\{\Omega_1^\alpha, \Omega_2^\alpha, B_\alpha\}$  be its moving Bishop frame.  $\Omega_1 B$ -Smarandache curves are defined by

$$\beta(s^*) = \frac{1}{\sqrt{2}} (\Omega_1^\alpha + B_\alpha). \quad (3.6)$$

Now we can investigate Bishop invariants of  $\Pi_1^\alpha B_\alpha$ -Smarandache curves of the curve  $\alpha = \alpha(s)$ . Differentiating (3.6) with respect to  $s$ , we have

$$\dot{\beta} = \frac{d\beta}{ds} \cdot \frac{ds^*}{ds} = \frac{1}{\sqrt{2}}(\xi_1^\alpha B_\alpha - \xi_1^\alpha \Omega_1^\alpha - \xi_2^\alpha \Omega_2^\alpha), \quad (3.7)$$

and

$$T_\beta \cdot \frac{ds^*}{ds} = \frac{1}{\sqrt{2}}(\xi_1^\alpha B_\alpha - \xi_1^\alpha \Omega_1^\alpha - \xi_2^\alpha \Omega_2^\alpha),$$

where

$$\frac{ds^*}{ds} = \frac{\xi_2^\alpha}{2}. \quad (3.8)$$

The tangent vector of the curve  $\beta$  can be written as follows

$$T_\beta = \frac{\sqrt{2}}{\xi_2^\alpha}(-\xi_1^\alpha \Omega_1^\alpha - \xi_2^\alpha \Omega_2^\alpha + \xi_1^\alpha B_\alpha). \quad (3.9)$$

Differentiating (3.9) with respect to  $s$  gives

$$\frac{dT_\beta}{ds^*} \cdot \frac{ds^*}{ds} = \frac{\xi_2^\alpha}{\sqrt{2}}(L_1(s)\Omega_1^\alpha + L_2(s)\Omega_2^\alpha + L_3(s)B_\alpha), \quad (3.10)$$

where

$$L_1(s) = -\xi_1^\alpha - (\xi_1^\alpha)^2 + \frac{\xi_1^\alpha \dot{\xi}_2^\alpha}{\xi_2^\alpha}, \quad L_2(s) = \xi_1^\alpha \xi_2^\alpha,$$

$$L_3(s) = -(\xi_1^\alpha)^2 + (\xi_2^\alpha)^2 + \dot{\xi}_1^\alpha - \frac{\xi_1^\alpha \dot{\xi}_2^\alpha}{\xi_2^\alpha}.$$

Substituting (3.8) into (3.10) gives

$$T'_\beta = \frac{2\sqrt{2}}{(\xi_2^\alpha)^2}(L_1(s)\Omega_1^\alpha + L_2(s)\Omega_2^\alpha + L_3(s)B_\alpha),$$

then the first curvature and the principal normal vector field of  $\beta$  are, respectively,

$$\|T'_\beta\| = \kappa_\beta = \frac{2\sqrt{2}}{(\xi_2^\alpha)^2} \sqrt{L_1^2(s) + L_2^2(s) - L_3^2(s)},$$

and

$$N_\beta = \frac{-1}{\sqrt{L_1^2(s) + L_2^2(s) - L_3^2(s)}}(L_1(s)\Omega_1^\alpha + L_2(s)\Omega_2^\alpha + L_3(s)B_\alpha).$$

On the other hand, we have

$$B_\beta = \frac{\sqrt{2}}{\xi_2^\alpha \sqrt{L_1^2(s) + L_2^2(s) - L_3^2(s)}} [(\xi_1^\alpha L_2(s) + \xi_2^\alpha L_3(s))\Omega_1^\alpha + (\xi_1^\alpha L_1(s) + \xi_1^\alpha L_3(s))\Omega_2^\alpha + (\xi_2^\alpha L_1(s) - \xi_1^\alpha L_2(s))B_\alpha].$$

Differentiating (3.7) with respect to  $s$  in order to calculate the torsion of the curve  $\beta$ , we

find

$$\ddot{\beta} = \frac{1}{\sqrt{2}} [ -((\xi_1^\alpha)^2 + \dot{\xi}_1^\alpha) \Omega_1^\alpha + (-\xi_1^\alpha \dot{\xi}_2^\alpha - \dot{\xi}_2^\alpha) \Omega_2^\alpha - (\ddot{\xi}_1^\alpha - (\xi_1^\alpha)^2 + (\xi_2^\alpha)^2) B_\alpha ],$$

and similarly

$$\begin{aligned} \ddot{\beta} = \frac{1}{\sqrt{2}} [ & (-2\xi_1^\alpha \dot{\xi}_1^\alpha - \ddot{\xi}_1^\alpha) \Omega_1^\alpha + (-\dot{\xi}_1^\alpha \dot{\xi}_2^\alpha - \ddot{\xi}_2^\alpha - \xi_1^\alpha \ddot{\xi}_2^\alpha) \Omega_2^\alpha \\ & + (-(\xi_1^\alpha)^3 - \xi_1^\alpha \dot{\xi}_1^\alpha + \xi_1^\alpha \dot{\xi}_2^\alpha \xi_2^\alpha - \xi_2^\alpha \dot{\xi}_2^\alpha) B_\alpha ]. \end{aligned}$$

The torsion of the curve  $\beta$  is

$$\tau_\beta = \frac{(\xi_2^\alpha)^4}{16\sqrt{2}} [ -\xi_1^\alpha M_1(s) - \xi_2^\alpha M_2(s) - \xi_1^\alpha M_3(s) ],$$

where

$$\begin{aligned} M_1(s) &= -3\xi_1^\alpha \dot{\xi}_1^\alpha - 2\xi_1^\alpha \dot{\xi}_2^\alpha - \dot{\xi}_1^\alpha \xi_2^\alpha - \xi_1^\alpha \dot{\xi}_1^\alpha, \\ M_2(s) &= -2\dot{\xi}_1^\alpha \xi_2^\alpha - 2(\dot{\xi}_2^\alpha)^2 - \xi_1^\alpha \dot{\xi}_2^\alpha - \xi_2^\alpha \dot{\xi}_2^\alpha, \\ M_3(s) &= \ddot{\xi}_1^\alpha + \ddot{\xi}_2^\alpha - (\xi_1^\alpha)^3 - (\xi_1^\alpha)^2 \xi_2^\alpha - \xi_1^\alpha (\xi_2^\alpha)^2 + (\xi_2^\alpha)^2. \end{aligned}$$

### 3.3 $\Omega_2 B$ -Smarandache Curves

**Definition 3.3** Let  $\alpha = \alpha(s)$  be a unit speed regular curve in  $E_1^3$  and  $\{\Omega_1^\alpha, \Omega_2^\alpha, B_\alpha\}$  be its moving Bishop frame.  $\Omega_2^\alpha B$ -Smarandache curves are defined by

$$\beta(s^*) = \frac{1}{\sqrt{2}} (\Omega_2^\alpha + B_\alpha). \quad (3.11)$$

Now we can investigate Bishop invariants of  $\Omega_1^\alpha B_\alpha$ -Smarandache curves of the curve  $\alpha = \alpha(s)$ . Differentiating (3.11) with respect to  $s$ , we have

$$\dot{\beta} = \frac{d\beta}{ds} \cdot \frac{ds^*}{ds} = \frac{1}{\sqrt{2}} (-\xi_2^\alpha B_\alpha - \xi_1^\alpha \Omega_1^\alpha - \xi_2^\alpha \Omega_2^\alpha), \quad (3.12)$$

and

$$T_\beta \cdot \frac{ds^*}{ds} = \frac{1}{\sqrt{2}} (-\xi_1^\alpha \Omega_1^\alpha - \xi_2^\alpha \Omega_2^\alpha - \xi_2^\alpha B_\alpha),$$

where

$$\frac{ds^*}{ds} = \sqrt{\frac{2(\xi_2^\alpha)^2 - (\xi_1^\alpha)^2}{2}}. \quad (3.13)$$

The tangent vector of the curve  $\beta$  can be written as follows

$$T_\beta = \frac{-\xi_1^\alpha \Omega_1^\alpha - \xi_2^\alpha \Omega_2^\alpha - \xi_2^\alpha B_\alpha}{\sqrt{2(\xi_2^\alpha)^2 - (\xi_1^\alpha)^2}}. \quad (3.14)$$

Differentiating (3.14) with respect to  $s$  gives

$$\frac{dT_\beta}{ds^*} \cdot \frac{ds^*}{ds} = (N_1(s) \Omega_1^\alpha + N_2(s) \Omega_2^\alpha + N_3(s) B_\alpha), \quad (3.15)$$



where

$$\begin{aligned} N_1(s) &= \frac{1}{2}(4\xi_2^\alpha \dot{\xi}_2^\alpha - 2\xi_1^\alpha \dot{\xi}_1^\alpha)(2(\xi_2^\alpha)^2 - (\xi_1^\alpha)^2)^{-\frac{3}{2}} \xi_1^\alpha \\ &\quad - (2(\xi_2^\alpha)^2 - (\xi_1^\alpha)^2)^{-\frac{1}{2}} \dot{\xi}_1^\alpha + (2(\xi_2^\alpha)^2 - (\xi_1^\alpha)^2)^{-\frac{1}{2}} \xi_1^\alpha \dot{\xi}_2^\alpha, \\ N_2(s) &= \frac{1}{2}(4\xi_2^\alpha \dot{\xi}_2^\alpha - 2\xi_1^\alpha \dot{\xi}_1^\alpha)(2(\xi_2^\alpha)^2 - (\xi_1^\alpha)^2)^{-\frac{3}{2}} \xi_1^\alpha \\ &\quad - (2(\xi_2^\alpha)^2 - (\xi_1^\alpha)^2)^{-\frac{1}{2}} \dot{\xi}_1^\alpha + (2(\xi_2^\alpha)^2 - (\xi_1^\alpha)^2)(\xi_2^\alpha)^2, \\ N_3(s) &= \frac{1}{2}(4\xi_2^\alpha \dot{\xi}_2^\alpha - 2\xi_1^\alpha \dot{\xi}_1^\alpha)(2(\xi_2^\alpha)^2 - (\xi_1^\alpha)^2)^{-\frac{3}{2}} \\ &\quad - (2(\xi_2^\alpha)^2 - (\xi_1^\alpha)^2)^{-\frac{1}{2}} ((\xi_2^\alpha)^2 - (\xi_1^\alpha)^2 - \dot{\xi}_2^\alpha). \end{aligned}$$

Substituting (3.13) into (3.15) gives

$$T'_\beta = \sqrt{\frac{2}{2(\xi_2^\alpha)^2 - (\xi_1^\alpha)^2}} (N_1(s)\Omega_1^\alpha + N_2(s)\Omega_2^\alpha + N_3(s)B_\alpha),$$

then the first curvature and the principal normal vector field of  $\beta$  are, respectively, found as follows

$$\kappa_\beta = \|T'_\beta\| = \sqrt{\frac{2}{2(\xi_2^\alpha)^2 - (\xi_1^\alpha)^2}} \sqrt{N_1^2(s) + N_2^2(s) + N_3^2(s)},$$

and

$$N_\beta = \frac{-1}{\sqrt{N_1^2(s) + N_2^2(s) + N_3^2(s)}} (N_1(s)\Omega_1^\alpha + N_2(s)\Omega_2^\alpha + L_3(s)B_\alpha). \quad (3.16)$$

On the other hand, we have

$$\begin{aligned} B_\beta &= \frac{1}{\sqrt{2(\xi_2^\alpha)^2 - (\xi_1^\alpha)^2} \sqrt{N_1^2(s) + N_2^2(s) + N_3^2(s)}} [(-\xi_2^\alpha N_3(s) + \xi_2^\alpha N_2(s))\Omega_1^\alpha \\ &\quad + (-\xi_2^\alpha N_3(s) + \xi_2^\alpha N_1(s))\Omega_2^\alpha + (\xi_1^\alpha N_2 - \xi_2^\alpha N_1(s))B_\alpha]. \end{aligned} \quad (3.17)$$

Differentiating (3.12) with respect to  $s$  in order to calculate the torsion of the curve  $\beta$ , we obtain

$$\ddot{\beta} = \frac{1}{\sqrt{2}} [(\xi_2^\alpha \xi_1^\alpha + \dot{\xi}_1^\alpha)\Omega_1^\alpha + ((\xi_2^\alpha)^2 - \dot{\xi}_2^\alpha)\Omega_2^\alpha + (-\dot{\xi}_2^\alpha + \xi_2^\alpha - (\xi_1^\alpha)^2)B_\alpha],$$

and similarly

$$\begin{aligned} \ddot{\beta} &= \frac{1}{\sqrt{2}} [(2\dot{\xi}_2^\alpha \xi_1^\alpha + \xi_2^\alpha \dot{\xi}_1^\alpha - \ddot{\xi}_1^\alpha - \xi_2^\alpha \xi_1^\alpha + (\xi_1^\alpha)^3)\Omega_1^\alpha \\ &\quad + (3\xi_2^\alpha \dot{\xi}_2^\alpha - \ddot{\xi}_2^\alpha - (\xi_2^\alpha)^2 - (\xi_1^\alpha)^2 \xi_2^\alpha)\Omega_2^\alpha \\ &\quad + ((\xi_1^\alpha)^2 \xi_2^\alpha - (\xi_2^\alpha)^3 + \xi_2^\alpha \dot{\xi}_2^\alpha - \ddot{\xi}_2^\alpha + \dot{\xi}_2^\alpha - 3\xi_1^\alpha \dot{\xi}_1^\alpha)B_\alpha]. \end{aligned}$$

The torsion of the curve  $\beta$  is

$$\begin{aligned} \tau_\beta &= \frac{2(\xi_2^\alpha)^2 - (\xi_1^\alpha)^2}{4\sqrt{2}} \{ [P_3(s)((\xi_2^\alpha)^2 - \dot{\xi}_2^\alpha) - P_2(s)(-\dot{\xi}_2^\alpha + \xi_2^\alpha - (\xi_1^\alpha)^2)] \xi_1^\alpha \\ &\quad + [P_3(s)(\xi_2^\alpha \xi_1^\alpha - \dot{\xi}_1^\alpha) - P_1(s)(-\dot{\xi}_2^\alpha + \xi_2^\alpha - (\xi_1^\alpha)^2)] \xi_2^\alpha \\ &\quad + [P_2(s)(\xi_2^\alpha \xi_1^\alpha - \dot{\xi}_1^\alpha) - P_1(s)((\xi_2^\alpha)^2 - \dot{\xi}_2^\alpha)] \xi_3^\alpha \}, \end{aligned}$$

where

$$\begin{aligned} P_1(s) &= 2\dot{\xi}_2^\alpha \xi_1^\alpha + \xi_2^\alpha \dot{\xi}_1^\alpha - \ddot{\xi}_1^\alpha - \xi_1^\alpha \dot{\xi}_1^\alpha + \xi_1^\alpha \xi_2^\alpha + (\xi_1^\alpha)^3, \\ P_2(s) &= 3\dot{\xi}_2^\alpha \xi_2^\alpha - \ddot{\xi}_2^\alpha - (\xi_2^\alpha)^2 - (\xi_1^\alpha)^2 \xi_2^\alpha, \\ P_3(s) &= (\xi_1^\alpha)^2 \xi_2^\alpha - (\xi_2^\alpha)^3 + \xi_2^\alpha \dot{\xi}_2^\alpha - \ddot{\xi}_2^\alpha + \dot{\xi}_2^\alpha - 3\dot{\xi}_1^\alpha \xi_1^\alpha. \end{aligned}$$

### 3.4 $\Omega_1\Omega_2B$ -Smarandache Curves

**Definition 3.4** Let  $\alpha = \alpha(s)$  be a unit speed regular curve in  $E_1^3$  and  $\{\Omega_1^\alpha, \Omega_2^\alpha, B_\alpha\}$  be its moving Bishop frame.  $\Omega_1^\alpha\Omega_2^\alpha B$ -Smarandache curves are defined by

$$\beta(s^*) = \frac{1}{\sqrt{3}}(\Omega_1^\alpha + \Omega_2^\alpha + B_\alpha). \quad (3.18)$$

Now we can investigate Bishop invariants of  $\Omega_1^\alpha\Omega_2^\alpha B$ -Smarandache curves of the curve  $\alpha = \alpha(s)$ . Differentiating (3.18) with respect to  $s$ , we have

$$\dot{\beta} = \frac{d\beta}{ds} \cdot \frac{ds^*}{ds} = \frac{1}{\sqrt{3}}(-\xi_1^\alpha \Omega_1^\alpha - \xi_2^\alpha \Omega_2^\alpha + (\xi_1^\alpha - \xi_2^\alpha) B_\alpha), \quad (3.19)$$

and

$$T_\beta \cdot \frac{ds^*}{ds} = \frac{1}{\sqrt{3}}(-\xi_1^\alpha \Omega_1^\alpha - \xi_2^\alpha \Omega_2^\alpha + (\xi_1^\alpha - \xi_2^\alpha) B_\alpha),$$

where

$$\frac{ds^*}{ds} = \sqrt{\frac{(\xi_1^\alpha - \xi_2^\alpha)^2 + (\xi_2^\alpha)^2 - (\xi_1^\alpha)^2}{3}}. \quad (3.20)$$

The tangent vector of the curve  $\beta$  is found as follows

$$T_\beta = \frac{1}{\sqrt{(\xi_1^\alpha - \xi_2^\alpha)^2 + (\xi_2^\alpha)^2 - (\xi_1^\alpha)^2}}(-\xi_1^\alpha \Omega_1^\alpha - \xi_2^\alpha \Omega_2^\alpha + (\xi_1^\alpha - \xi_2^\alpha) B_\alpha). \quad (3.21)$$

Differentiating (3.21) with respect to  $s$ , we find

$$\begin{aligned} \frac{dT_\beta}{ds^*} \cdot \frac{ds^*}{ds} &= [-Q(s)\dot{\xi}_1^\alpha - Q(s)(\xi_1^\alpha)^2 + Q(s)\xi_1^\alpha \xi_2^\alpha - Q'(s)\xi_1^\alpha] \Omega_1^\alpha \\ &\quad + [-Q(s)\dot{\xi}_2^\alpha - Q(s)\xi_1^\alpha \xi_2^\alpha + Q(s)(\xi_2^\alpha)^2 - Q'(s)\xi_2^\alpha] \Omega_2^\alpha \\ &\quad + [Q(s)(\xi_1^\alpha - \xi_2^\alpha)' - Q(s)(\xi_1^\alpha)^2 + Q'(s)(\xi_1^\alpha - \xi_2^\alpha)] B_\alpha, \end{aligned} \quad (3.22)$$

where

$$Q(s) = \frac{1}{\sqrt{(\xi_1^\alpha - \xi_2^\alpha)^2 + (\xi_2^\alpha)^2 - (\xi_1^\alpha)^2}}.$$

Substituting (3.20) into (3.22) by using (3.23) gives

$$T'_\beta = \frac{\sqrt{3}}{K(s)}(M_1(s)\Omega_1^\alpha + M_2(s)\Omega_2^\alpha + M_3(s)B_\alpha),$$

where

$$\begin{aligned}
R_1(s) &= -Q(s)\dot{\xi}_1^\alpha - Q(s)(\xi_1^\alpha)^2 + Q(s)\xi_1^\alpha\xi_2^\alpha - Q'(s)\xi_1^\alpha, \\
R_2(s) &= -Q(s)\dot{\xi}_2^\alpha - Q(s)\xi_1^\alpha\xi_2^\alpha + Q(s)(\xi_2^\alpha)^2 - Q'(s)\xi_2^\alpha, \\
R_3(s) &= Q(s)(\xi_1^\alpha - \xi_2^\alpha)' - Q(s)(\xi_1^\alpha)^2 + Q'(s)(\xi_1^\alpha - \xi_2^\alpha).
\end{aligned} \tag{3.23}$$

Then the first curvature and the principal normal vector field of  $\beta$  are, respectively, obtained as follows

$$\kappa_\beta = \left\| T'_\beta \right\| = \frac{\sqrt{3}}{K(s)} \sqrt{-R_1^2(s) + R_2^2(s) + R_3^2(s)},$$

and

$$\begin{aligned}
B_\beta &= \frac{-1}{K(s)\sqrt{-R_1^2(s) + R_2^2(s) + R_3^2(s)}} [(M_2(\xi_1^\alpha - \xi_2^\alpha) + M_3\xi_2^\alpha)\Omega_1^\alpha \\
&\quad + (M_1(\xi_1^\alpha - \xi_2^\alpha) + M_3\xi_2^\alpha)\Omega_2^\alpha + (\xi_2^\alpha M_1(s) - \xi_1^\alpha M_2(s))B_\alpha].
\end{aligned} \tag{3.24}$$

Differentiating (3.19) with respect to  $s$  in order to calculate the torsion of the curve  $\beta$ , we obtain

$$\begin{aligned}
\dot{\beta} &= \frac{1}{\sqrt{3}} [(-\dot{\xi}_1^\alpha - (\xi_1^\alpha)^2 + \xi_1^\alpha\xi_2^\alpha)\Omega_1^\alpha \\
&\quad + (-\dot{\xi}_2^\alpha + (\xi_2^\alpha)^2 - \xi_1^\alpha\xi_2^\alpha + (\xi_2^\alpha)^2)\Omega_2^\alpha + (\dot{\xi}_1^\alpha - \dot{\xi}_2^\alpha - (\xi_1^\alpha)^2)B_\alpha],
\end{aligned}$$

and similarly

$$\begin{aligned}
\ddot{\beta} &= \frac{1}{\sqrt{3}} [(-\ddot{\xi}_1^\alpha - 2\xi_1^\alpha\dot{\xi}_1^\alpha + \dot{\xi}_1^\alpha\xi_2^\alpha + \xi_1^\alpha\dot{\xi}_2^\alpha)\Omega_1^\alpha \\
&\quad + (-\ddot{\xi}_2^\alpha + 4\xi_2^\alpha\dot{\xi}_2^\alpha - \dot{\xi}_1^\alpha\xi_2^\alpha - 2\xi_1^\alpha\dot{\xi}_2^\alpha)\Omega_2^\alpha \\
&\quad + (\xi_2^\alpha\dot{\xi}_2^\alpha + \xi_1^\alpha(\xi_2^\alpha)^2 - (\xi_1^\alpha)^2 - (\xi_1^\alpha)^3 + (\xi_1^\alpha)^2\xi_2^\alpha)B_\alpha].
\end{aligned}$$

The torsion of the curve  $\beta$  is

$$\begin{aligned}
\tau_\beta &= \frac{1}{9 - M_1^2(s) + M_2^2(s) + M_3^2(s)} \{ [Q_3(s)(-\dot{\xi}_2^\alpha + 2(\xi_2^\alpha)^2 - \xi_1^\alpha\xi_2^\alpha) \\
&\quad - Q_2(s)(\xi_1^\alpha - \dot{\xi}_2^\alpha - \xi_1^\alpha\xi_2^\alpha)]\xi_1^\alpha + [Q_3(s)(-\dot{\xi}_1^\alpha - (\xi_1^\alpha)^2 + \xi_1^\alpha\xi_2^\alpha) \\
&\quad - Q_1(s)(-\dot{\xi}_2^\alpha + 2(\xi_2^\alpha)^2 - \xi_1^\alpha\xi_2^\alpha)]\xi_2^\alpha - [Q_2(s)(-\xi_1^\alpha - (\xi_1^\alpha)^2 + \xi_1^\alpha\xi_2^\alpha) \\
&\quad - Q_1(s)(-\xi_2^\alpha + 2(\xi_2^\alpha)^2 - \xi_1^\alpha\xi_2^\alpha)](\xi_1^\alpha - \xi_2^\alpha) \},
\end{aligned}$$

where

$$\begin{aligned}
Q_1(s) &= -\dot{\xi}_1^\alpha - (\xi_1^\alpha)^2 + \xi_1^\alpha\xi_2^\alpha, \\
Q_2(s) &= -\dot{\xi}_1^\alpha\xi_2^\alpha + 2\xi_2^\alpha\dot{\xi}_2^\alpha - \ddot{\xi}_2^\alpha, \\
Q_3(s) &= \xi_1^\alpha(\xi_2^\alpha)^2 - (\xi_1^\alpha)^2 - (\xi_1^\alpha)^3 + (\xi_1^\alpha)^2\xi_2^\alpha + \xi_2^\alpha\dot{\xi}_2^\alpha.
\end{aligned}$$

### 3.5 Example

**Example 3.1** Next, let us consider the following unit speed curve  $w = w(s)$  in  $E_1^3$  as follows

$$w(s) = (s, \sqrt{2} \ln(\sec h(s)), \sqrt{2} \arctan(\sinh(s))). \tag{3.25}$$

It is rendered in Figure 1, as follows

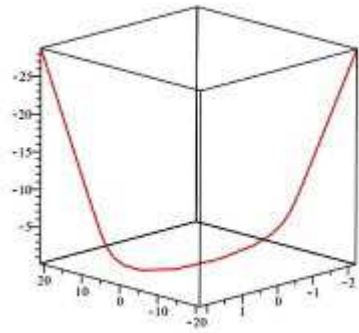

**Figure 1**

The curvature function and Serret-Frenet frame of the curve  $w(s)$  is expressed as

$$\begin{aligned} T &= (1, -\sqrt{2} \tanh(s), \sqrt{2} \operatorname{sech}(s)), \\ N &= (0, -\operatorname{sech}(s), -\tanh(s)), \\ B &= (\sqrt{2}, -\tanh(s), \operatorname{sech}(s)), \end{aligned} \quad (3.26)$$

and

$$\kappa = \sqrt{2} \operatorname{sech}(s), \theta = \sqrt{2} \int_0^s \operatorname{sech}(s) ds = \sqrt{2} \arctan(\sinh(s)). \quad (3.27)$$

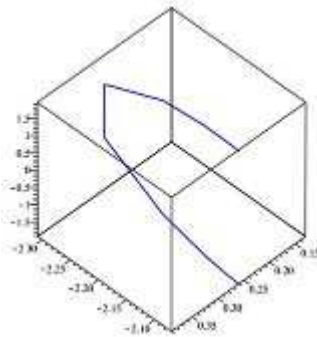

**Figure 2**  $\Omega_1\Omega_2$ -Smarandache curve

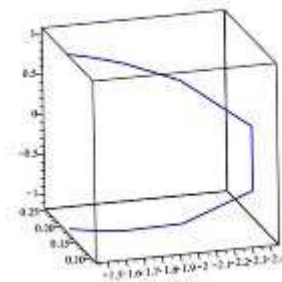

**Figure 3**  $\Omega_1B$ -Smarandache curve

Also the Bishop frame is computed as

$$\begin{aligned} \Omega_1 &= (-\sinh \theta, -\sqrt{2} \sinh \theta \tanh(s) - \cosh \theta \operatorname{sech}(s), \\ &\quad -\sqrt{2} \sinh \theta \operatorname{sech}(s) - \cosh \theta \tanh(s)), \end{aligned} \quad (3.28)$$

$$\begin{aligned} \Omega_2 &= (\cosh \theta, -\sqrt{2} \cosh \theta \tanh(s) + \sinh \theta \operatorname{sech}(s), \\ &\quad \sqrt{2} \cosh \theta \operatorname{sech}(s) - \sinh \theta \tanh(s)), \end{aligned} \quad (3.29)$$

$$B = (\sqrt{2}, -\tanh(s), \operatorname{sech}(s)). \quad (3.30)$$

Let us see the graphs which belong to all versions of Smarandache curves according to the Bishop frame in  $E_1^3$ .

The parametrizations and plottings of  $\Omega_1\Omega_2, \Omega_1B, \Omega_2B$  and  $\Omega_1\Omega_2B$ – Smarandache curves are, respectively, given in Figures 2-5.

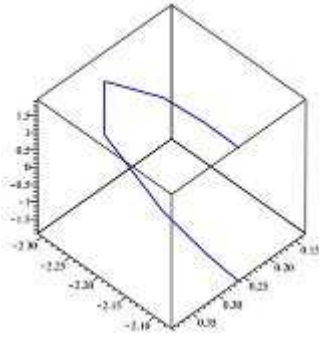

Figure 4  $\Omega_2B$ -Smarandache curve

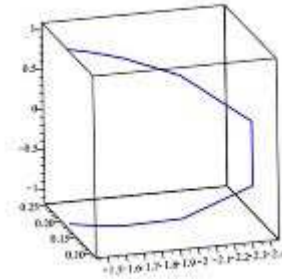

Figure 5  $\Omega_1\Omega_2B$ -Smarandache curve

#### §4. Smarandache Breadth Curves According to the Bishop Frame of Type-2 in $E_1^3$

A regular curve more than 2 breadths in Minkowski 3-space is called a Smarandache breadth curve.

Let  $\alpha = \alpha(s)$  be a Smarandache breadth curve, and also suppose that  $\alpha = \alpha(s)$  is a simple closed curve in  $E_1^3$ . This curve will be denoted by  $(C)$ . The normal plane at every point  $P$  on the curve meets the curve at a single point  $Q$  other than  $P$ . We call the point  $Q$  as the opposite point of  $P$

We consider a curve  $\alpha^* = \alpha^*(s^*)$ , in the class  $\Gamma$ , which has parallel tangents  $\zeta$  and  $\zeta^*$  at opposite directions at the opposite points  $\alpha$  and  $\alpha^*$  of the curve. A simple closed curve having parallel tangents in opposite directions at opposite points can be represented with respect to Bishop frame by the equation

$$\alpha^*(s^*) = \alpha(s) + \lambda\Omega_1 + \mu\Omega_2 + \eta B, \quad (4.1)$$

where  $\lambda(s), \mu(s)$  and  $\eta(s)$  are arbitrary functions,  $\alpha$  and  $\alpha^*$  are opposite points.

Differentiating both sides of (4.1) and considering Bishop equations, we have

$$\begin{aligned} \frac{d\alpha^*}{ds} = \Omega_1^* \frac{ds^*}{ds} &= \left( \frac{d\lambda}{ds} - \eta\xi_1 + 1 \right) \Omega_1 + \left( \frac{d\mu}{ds} - \eta\xi_2 \right) \Omega_2 \\ &+ \left( \frac{d\eta}{ds} + \lambda\xi_1 - \mu\xi_2 \right) B. \end{aligned} \quad (4.2)$$

Since  $\Omega_1^* = -\Omega_1$ , rewriting (4.2) we obtain respectively

$$\frac{d\lambda}{ds} = \eta\xi_1 - 1 - \frac{ds^*}{ds}, \quad \frac{d\mu}{ds} = \eta\xi_2, \quad \frac{d\eta}{ds} = -\lambda\xi_1 + \mu\xi_2. \quad (4.3)$$

If we call  $\theta$  as the angle between the tangent of the curve  $(C)$  at the point  $\alpha(s)$  with a given direction and consider  $\frac{d\theta}{ds} = \tau$ , (4.3) turns into the following form:

$$\frac{d\lambda}{d\theta} = \eta\frac{\xi_1}{\tau} - \frac{1}{\tau}\left(1 + \frac{ds^*}{ds}\right), \quad \frac{d\mu}{d\theta} = \eta\frac{\xi_2}{\tau}, \quad \frac{d\eta}{d\theta} = -\frac{\lambda}{\tau}\xi_1 + \frac{\mu}{\tau}\xi_2, \quad (4.4)$$

where  $\frac{ds^*}{ds} = \frac{ds^*}{d\theta} \cdot \frac{d\theta}{ds} = \frac{1}{\tau} \frac{ds^*}{d\theta}$ ,  $1 + \frac{ds^*}{ds} = f(\theta)$ ,  $\tau \neq 0$ .

Using system (4.4), we have the following vectorial differential equation with respect to  $\lambda$  as follows

$$\begin{aligned} & \frac{d^3\lambda}{d\theta^3} + \left\{ \frac{\tau^2}{\xi_1^2\xi_2} f(\theta) - \left( \frac{\xi_1\xi_2}{\tau^3} \left( \frac{\xi_1}{\tau} \right)' \right) \frac{\tau}{\xi_1} \right\} \frac{d^2\lambda}{d\theta^2} + \left\{ \left( \frac{\xi_1}{\tau} \right)^2 \right. \\ & + \left[ \frac{\xi_1}{\tau^2} \left( \frac{\xi_1}{\tau} \right)' \right] (1-\lambda) \left( \frac{\tau}{\xi_1} \right)' - \left[ \frac{\xi_1\xi_2}{\tau^3} \left( \frac{\xi_1}{\tau} \right)' \right] \left( \frac{\tau}{\xi_1} \right) \\ & - \left[ \frac{\xi_1\xi_2}{\tau^3} \left( \frac{\xi_1}{\tau} \right)' \right] - \left[ \frac{\xi_2^2}{\tau^3} \left( \frac{\xi_1}{\tau} \right)' \right] + \left[ \frac{1}{\xi_1} \left( \frac{\tau}{\xi_2} \right) \left( \frac{\tau}{\xi_2} \right)' f(\theta) \right] \right\} \frac{d\lambda}{d\theta} \\ & + \left\{ \left[ \frac{\xi_1\xi_2}{\tau^3} \left( \frac{\xi_1}{\tau} \right)' \right] \left( \frac{\tau^2}{\xi_1\xi_2} \right) \left( \frac{\tau}{\xi_1} \right)' \right\} \left( \frac{d\lambda}{d\theta} \right)^2 + \left\{ \frac{1}{\xi_1} + \frac{\tau}{\xi_1} \right\} \frac{d\lambda}{d\theta} \frac{d^2\lambda}{d\theta^2} \\ & + \left\{ \left( \frac{\xi_1}{\tau} \right)^2 + \left[ \frac{\xi_1\xi_2}{\tau^3} \left( \frac{\xi_1}{\tau} \right)' \right] \frac{1}{\xi_1} f(\theta) + \left( \frac{\xi_1}{\xi_2} - 1 \right) \frac{1}{\xi_1} f(\theta) \right\} \lambda \\ & + \left\{ \left[ \left( \frac{\xi_1}{\tau} \right)^2 + \frac{1}{\xi_1} f(\theta) \right] \left[ \frac{\xi_1\xi_2}{\tau^3} \left( \frac{\xi_1}{\tau} \right)' \right] \left[ \frac{\tau}{\xi_2} \left( \frac{1}{\xi_1} \right)' f(\theta) + \frac{\tau}{\xi_1\xi_2} f'(\theta) + \frac{\xi_1}{\xi_2} \right] \right\} \\ & + \left\{ \frac{\xi_1\xi_2}{\tau^3} \left( \frac{\xi_1}{\tau} \right)' \left[ \left( \frac{1}{\xi_1} \right)' f(\theta) - \left( \frac{1}{\xi_1} \right) f'(\theta) + \frac{\xi_2}{\xi_1} \frac{1}{\tau} f(\theta) \right] \right. \\ & \left. + \left( \frac{1}{\tau} \right)' f(\theta) + \frac{1}{\tau} f'(\theta) \right\} = 0. \end{aligned} \quad (4.5)$$

The equation (4.5) is a characterization for  $\alpha^*$ . If the distance between opposite points of  $(C)$  and  $(C^*)$  is constant, then we can write that

$$\|\alpha^* - \alpha\| = -\lambda^2 + \mu^2 + \eta^2 = l^2 = \text{const.}, \quad (4.6)$$

hence, we write

$$-\lambda \frac{d\lambda}{d\theta} + \mu \frac{d\mu}{d\theta} + \eta \frac{d\eta}{d\theta} = 0. \quad (4.7)$$

Considering the system (4.4) together with (4.7), we obtain

$$\lambda f(\theta) = \eta \left( \frac{\xi_1}{\tau} - \tau \eta \xi_2 - \xi_1 \right). \quad (4.8)$$

From system (4.4) we have

$$\eta = \frac{\tau}{\xi_1} \frac{d\lambda}{d\theta} + \frac{1}{\xi_1} f(\theta). \quad (4.9)$$

Substituting (4.9) into (4.8) gives

$$\lambda f(\theta) = \left(\tau \frac{d\lambda}{d\theta} + f(\theta)\right) \left(\frac{\xi_1}{\tau} - \tau\eta\xi_2 - \xi_1\right)$$

or

$$\tau \frac{d\lambda}{d\theta} + f(\theta) = \frac{\lambda f(\theta)}{G(\theta)}, \quad (4.10)$$

where  $G(\theta) = \frac{\xi_1}{\tau} - \tau\eta\xi_2 - \xi_1, \tau \neq 0$ .

Thus we find

$$\lambda = \int_0^\theta \frac{f(\theta)}{\tau} \left(\frac{\lambda}{G(\lambda)} - 1\right) d\theta, \quad (4.11)$$

and also from (4.4)<sub>2</sub>, (4.9) and (4.4)<sub>1</sub> we obtain

$$\mu = \int_0^\theta \left(\frac{d\lambda}{d\theta} + \frac{f(\theta)}{\tau}\right) \xi_2 d\theta. \quad (4.12)$$

and

$$\eta = \int_0^\theta \left[\frac{\tau}{\xi_1} \left(\frac{d\lambda}{d\theta} + \frac{f(\theta)}{\tau^2}\right)\right] d\theta. \quad (4.13)$$

## References

- [1] Karacan MK, Bükçü B (2008), An alternative moving frame for a tubular surface around a spacelike curve with a spacelike normal in Minkowski 3-space, *Rend Circ Mat Palermo*, 57 (2):193-201
- [2] Hanson AJ, Ma H (1995), Quaternion frame approach to streamline visualization, *IEEE T Vis Comput Gr.*, 1(2): 164-174.
- [3] Liu H., Pei D (2013), Singularities of a space curve according to the relatively parallel adapted frame and its visualization, *Math Probl Eng. Art*, ID 512020, 12 pp.
- [4] Bishop LR(1975), There is more than one way to frame a curve, *Am. Math. Mon.*, 82: 246-251.
- [5] Hanson AJ (2005), *Visualizing Quaternions*, Morgan Kaufmann, San Francisco.
- [6] Bükçü B, Karacan MK (2009), The slant helices according to bishop frame of the spacelike curve in Lorentzian space, *J. Interdiscipl. Math.*, 12(5):691-700.
- [7] Özdemir M, Ergin AA (2008), Parallel frames of non-lightlike curves, *Mo. J. Math. Sci.*, 20(2):127-137.
- [8] Yılmaz S (2010), Bishop spherical images of a spacelike curve in Minkowski 3-space, *Int. J. Phys. Sci.*, 5(6):898-905.
- [9] Turgut M, Yılmaz S (2008), Smarandache curves in Minkowski space-time, *Int. J. Math. Comb.*, 3:51-55.
- [10] Turgut (2009), Smarandache breadth pseudo null curves in Minkowski space-time, *Int. J. Math. Comb.*, 1:46-49.
- [11] Ali AT (2010), Special Smarandache curves in the Euclidean space, *Int. J. Math. Comb.*, 2:30-36.

- [12] Çetin M, Tuncer Y, Karacan MK (2014), Smarandache curves according to Bishop frame in Euclidean 3-space, *General Mathematical Notes*, 20:50-56.
- [13] Taşköprü K, Tosun M (2014), Smarandache curves on  $S^2$ , *Bol. Soc. Paran. Math.*, 32(1):51-59.
- [14] Bayrak N, Bektaş Ö, Yüce S (2012), Special Smarandache curves in  $E_1^3$ , *arXiv: 1204.566v1 [math.HO]*
- [15] Euler L (1870), De curvis triangularibus, *Acta Acad. Petropol.*, 3-30.
- [16] Köse Ö (1984), Some properties of ovals and curves of constant width in a plane, *Doğa Turk. J. Math.*, (8) 2:119-126.
- [17] Köse Ö (1986), On space curves of constant breadth, *Doğa Turk. J. Math.*, (10)1:11-14.
- [18] Fujivara M (1914), On space curves of constant breadth, *Tohoku Math. J.*, 5:179-184.
- [19] Yılmaz S, Turgut M (2010), A new version of Bishop frame and an application to spherical images, *J. Math. Anal Appl.*, 371:764-776.
- [20] Yılmaz S (2015), A new version of Bishop frame & application to spherical images of spacelike curve in Minkowski 3-Space  $E_1^3$ , *Prespacetime Journal*, (6)12:1414-1425.
- [21] Yılmaz S, Ünlütürk Y (2015), A note on spacelike curves according to type-2 Bishop frame in Minkowski 3-space  $E_1^3$ , *Int. Jour. Pure Appl. Math.*, 103(2):321-332.
- [22] Mağden A, Köse Ö (1997), On the curves of constant breadth, *Turk. J. Math.*, 21(3):227-284.
- [23] Lopez R (2010), Differential geometry of curves and surfaces in Lorentz-Minkowski space, *Int. Elect. Jour. Geom.*, 3(2):67-101.
- [24] O'Neill B (1983), *Semi-Riemannian Geometry with Applications to Relativity*, Academic Press, New York.



## Characterization of Locally Dually Flat Special Finsler $(\alpha, \beta)$ - Metrics

Brijesh Kumar Tripathi

(Department of Mathematics, L.E. College Morbi(Gujarat) 363642, India)

K.B. Pandey

(Department of Mathematics, K.N.I.T. ,Sultanpur (U.P.) 228118, India)

E-mail: brijeshkumartripathi4@gmail.com, kunjbiharipandey05@gmail.com

**Abstract:** The concept of locally dually flat Finsler metrics originate from information geometry. As we know,  $(\alpha, \beta)$  - metrics defined by a Riemannian metric  $\alpha$  and a 1-form  $\beta$ , represent an important class of Finsler metrics .In the year 2014, S. K. Narasimhamurthy ,A.R. Kavyashree and Y. K. Mallikarjun obtained characterization of locally first approximate Matsumoto metric [1].In continuation of the paper we study and characterize locally dually flat for a special Finsler  $(\alpha, \beta)$  metric  $F = \alpha + \beta + \frac{\beta^2}{\alpha} + \frac{\beta^3}{\alpha^2}$  with isotropic S-curvature, which is not Riemannian.

**Key Words:** Finsler metric, Riemannian metric;one form metric, S-curvature, locally dually flat metric, locally Minkowskian metric.

**AMS(2010):** 53C60, 53B40

### §1. Introduction

The notion of dually flat metric was first introduced by S. I. Amari and H. Nagaoka, while studying the information geometry on Riemannian spaces [2]. Later, Z. Shen extended the notion of dually flatness to Finsler metrics [7]. Dually flat Finsler metrics form a special important class of Finsler metrics in Finsler information geometry, which play a very important role in studying flat Finsler information structures ([4], [5], [6], [7], and [11]). In 2009, the authors of [4] classified the locally dual flat Randers metrics with almost isotropic flag curvature. Recently, Q. Xia worked on the dual flatness of Finsler metrics of isotropic flag curvature as well as scalar flag curvature ([10], [11]). Also, Q. Xia studied and gave a characterization of locally dually flat  $(\alpha, \beta)$ -metrics on an  $n$ -dimensional manifold  $M$  ( $n \geq 3$ ) [9]. Further in 2014, the authors of [1] discuss characterization of locally dually flat first approximate Matsumoto metric.

The first example of non-Riemannian dually flat metrics is the Funk metric given by ([4],

---

<sup>1</sup>Received June 13, 2016, Accepted November 8, 2016.

[7]):

$$F = \frac{\sqrt{(1 - |x|^2|y|^2) + \langle x, y \rangle^2}}{1 - |x|^2} \pm \frac{\langle x, y \rangle}{1 - |x|^2}$$

This metric is defined on the unit ball  $B^n(\mu) \subseteq R^n$  and is a Randers metric with constant flag curvature  $K = \frac{-1}{4}$ . This is the only known example of locally dually flat metric with non-zero constant flag curvature up to now.

In this paper, we study and characterize locally dually flat Finsler metric with isotropic S-curvature, which is not Riemannian.

## §2. Preliminaries

Let  $M$  be an  $n$ -dimensional smooth manifold. We denote by  $TM$  the tangent bundle of  $M$  and by  $(x, y) = (x^i, y^j)$  the local coordinates on the tangent bundle  $TM$ . A Finsler manifold  $(M, F)$  is a smooth manifold equipped with a function  $F : TM \rightarrow [0, \infty)$ , which has the following properties:

- Regularity:  $F$  is smooth in  $TM \setminus \{0\}$ ;
- Positive homogeneity:  $F(x, \lambda y) = \lambda F(x, y), \forall \lambda > 0$ ;
- Strong convexity: the Hessian matrix of  $F^2, g_{ij}(x, y) = \frac{1}{2} \frac{\partial^2 F^2(x, y)}{\partial x^i \partial y^j}$  is positive definite on  $TM \setminus \{0\}$ .

We call  $F$  and the tensor  $g_{ij}$  the Finsler metric and the fundamental tensor of  $M$ , respectively.

For a Finsler metric  $F = F(x, y)$ , its geodesic curves are characterized by the system of differential equations  $\ddot{c}^i + 2G^i(\dot{c}) = 0$ , where the local functions  $G^i = G^i(x, y)$  are called the spray coefficients and given by

$$G^i = \frac{g^{ij}}{4} \{ [F^2]_{x^k y^l} y^k - [F^2]_{x^l} \}, \forall y \in T_x M.$$

**Definition 2.1** A Finsler metric  $F = F(x, y)$  on a manifold  $M$  is said to be locally dually flat if at any point there is a standard coordinate system  $(x^i, y^i)$  in  $TM$  which satisfies

$$[F^2]_{x^k y^l} y^k = 2[F^2]_{x^l}$$

In this case, the system of coordinates  $(x^i)$  is called an adapted local coordinate system. It is easy to see that every locally Minkowskian metric is locally dually flat. But the converse is not generally true [4].

**Definition 2.2** A Finsler metric is said to be locally projectively flat if at any point there is a local coordinate system in which the geodesics are straight lines as point sets. It is known that a Finsler metric  $F(x, y)$  on an open domain  $U \subset R^n$  is locally projectively flat if and only if its

geodesic coefficients  $G^i$  are of the form

$$G^i = Py^i$$

where  $P : TU = UXR^n \rightarrow R$  is positively homogeneous of degree one,  $P(x, \lambda y) = \lambda P(x, y), \forall \lambda > 0$ . We call  $P(x, y)$  the projective factor of  $F(x, y)$ .

**Lemma 2.1**([4]) *Let  $F = F(x, y)$  be a Finsler metric on an open subset  $U \subset R^n$ . Then  $F$  is locally flat and projectively flat on  $U$  if and only if  $F_{x^k} = CF_{y^k}$ , where  $C$  is a constant.*

The S-curvature is a scalar function on TM, which was introduced by Z. Shen to study volume comparison in Riemann-Finsler geometry [3]. The S-curvature measures the average rate of change of  $(T_x M, F_x = F|_{T_x M})$  in the direction  $y \in T_x M$ . It is known that  $S = 0$  for Berwald metrics.

**Definition 2.3** *A Finsler metric  $F$  on an  $n$ -dimensional manifold  $M$  is said to have isotropic S-curvature if  $S = (n + 1)c(x)F$ , for some scalar function  $c$  on  $M$ .*

For a Finsler metric  $F$  on an  $n$ -dimensional manifold  $M$ , the Busemann-Hausdorff volume form  $dV_F = \sigma_F(x)dx^1 \cdots dx^n$  is defined by

$$\sigma_F = \frac{Vol B^n(1)}{Vol(y^i \in R^n | F(x, y^i \frac{\partial}{\partial x^i})|_x < 1)}$$

Here Vol denotes the Euclidean volumes and  $B^n(1)$  denotes the unit ball in  $R^n$ . Then the S-curvature is defined by

$$S(y) = \frac{\partial G^i}{\partial y^i}(x, y) - y^i \frac{\partial (In \sigma_F)}{\partial x^i}$$

where

$$y = y^i \frac{\partial (In \sigma_F)}{(\partial x^i)}|_x \in T_x M [8].$$

For an  $(\alpha, \beta)$ -metric, one can write  $F = \alpha\phi(s)$ , where  $s = \frac{\beta}{\alpha}$  and  $\phi = \phi(s)$  is a  $C^\infty$  function on the interval  $(-b_0, b_0)$  with certain regularity properties,  $\alpha = \sqrt{(a_{ij}y^i y^j)}$  is a Riemannian metric and  $\beta = b_i(x)y^i$  is a 1-form on  $M$ .

We further denote

$$b_{i|j}\theta^j = db_i - b_j\theta_i^j,$$

where  $\theta^i = dx^i$  and  $\theta_j^i = \Gamma_{ik}^j dx^k$  denotes the coefficients of the Levi-Civita connection form of  $\alpha$ .

Let

$$r_{ij} = \frac{1}{2}(b_{i|j} + b_{j|i}), s_{ij} = \frac{1}{2}(b_{i|j} - b_{j|i}).$$

Clearly,  $\beta$  is closed if and only if  $s_{ij} = 0$ . An  $(\alpha, \beta)$ -metric is said to be trivial if  $r_{ij} = s_{ij} = 0$ . We put

$$\begin{aligned} r_{i0} &= r_{ij}y^j, r_{00} = r_{ij}y^i y^j, r_j = r_{ij}b^i, \\ s_{i0} &= s_{ij}y^j, s_j = s_{ij}b^i, s_0 = s_j b^i. \end{aligned}$$

By direct computation, we can obtain a formula for the mean Cartan torsion of an  $(\alpha, \beta)$ -metric as follow:

$$I_i = -\frac{\phi(\phi - s\phi')}{2\Delta\phi\alpha^2}(\alpha b_i - sy_i).$$

Clearly, an  $(\alpha, \beta)$  -metric  $F = \alpha\phi(s)$ ,  $s = \frac{\beta}{\alpha}$  is Riemannian if and only if  $\phi = 0$ . Hence, we further we assume that  $\phi \neq 0$ .

**Theorem 2.2**([9]) *Let  $F = \alpha\phi(s)$ ,  $s = \frac{\beta}{\alpha}$  be an  $(\alpha, \beta)$ -metric on an  $n$ -dimensional manifold  $M^n$  ( $n \geq 3$ ), where  $\alpha = \sqrt{(a_{ij}y^i y^j)}$  is a Riemannian metric and  $\beta = b_i(x)y^i \neq 0$ . is an 1-form on  $M$ . Suppose that  $F$  is not Riemannian and  $\phi'(s) \neq 0$ . Then  $F$  is locally dually flat on  $M$  if and only if  $(\alpha, \beta)$  and  $\phi = \phi(s)$  satisfy*

- (1)  $s_{10} = \frac{1}{3}(\beta\theta_l - \theta b_l)$ ;
- (2)  $r_{00} = \frac{2}{3}\theta\beta + \left[\tau + \frac{2}{3}(b^2\tau - \theta_l b^l)\right]\alpha^2 + \frac{1}{3}(3k_2 - 2 - 3k_3 b^2)\tau\beta^2$ ;
- (3)  $G'_\alpha = \frac{1}{3}[2\theta + (3k_1 - 2)\tau\beta]y^l + \frac{1}{3}(\theta^l \tau b^l)\alpha^2 + \frac{1}{2}k_3\tau\beta^2 b^1$ ;
- (4)  $\tau[s(k_2 - k_3 s^2)(\phi\phi' - s\phi'^2 - s\phi\phi'') - (\phi'^2 + \phi\phi'') + k_1\phi(\phi - s\phi')] = 0$ .

where  $\tau = \tau(x)$  is a scalar function,  $\theta = \theta_i(x)y^i$  is an 1-form on  $M$ ,  $\theta^l = a^{lm}\theta_m$

$$k_1 = \Pi(0), k_2 = \frac{\Pi'(0)}{Q(0)}, k_3 = \frac{1}{6Q^2(0)}[3Q''(0)\Pi'(0) - 6\Pi^2(0) - Q(0)\Pi'''(0)].$$

and

$$Q = \frac{\phi'}{(\phi - s\phi')}, \quad \Pi = \frac{(\phi'^2 + \phi\phi'')}{(\phi(\phi - s\phi'))}.$$

In [4], Cheng-Shen studied the class of  $(\alpha, \beta)$ -metrics of non-Randers type  $\phi \neq t_1\sqrt{1 + t_2 s^2} + t_3 s$ . with isotropic S-curvature and obtained the following.

**Theorem 2.3**([3]) *Let  $F = \alpha\phi(s)$ ,  $s = \frac{\beta}{\alpha}$  be a non-Riemannian  $(\alpha, \beta)$ -metric on a manifold and  $b = \|\beta_x\|_\alpha$ . Suppose that  $\phi \neq t_1\sqrt{1 + t_2 s^2} + t_3 s$  for any constants  $t_1 > 0, t_2$  and  $t_3$ . Then  $F$  is of isotropic S-curvature  $S = (n + 1)cF$  if and only if one of the following assertions holds*

- (1)  $\beta$  Satisfies

$$r_{ij} = \varepsilon(b^2 a_{ij} - b_i b_j), s_j = 0, \quad (2.1)$$

where  $\varepsilon = \varepsilon(x)$  is a scalar function, and  $c = c(x)$  satisfies

$$\Phi = -2(n + 1)k \frac{\phi\Delta^2}{(b^2 - s^2)}, \quad (2.2)$$

where  $k$  is a real constant. In this case,  $S = (n + 1)cF$  with  $c = k\varepsilon$ ;

- (2)  $\beta$  satisfies

$$r_{ij} = 0, s_{ij} = 0. \quad (2.3)$$

In this case,  $S = 0$ , regardless of the choice of a particular  $\phi$ .

### §3. Characterization of Locally Dually Flat Finsler $(\alpha, \beta)$ Metric

**Theorem 3.1** *Let  $F = \alpha + \beta + \frac{\beta^2}{\alpha} + \frac{\beta^3}{\alpha^2}$  be a special Finsler  $(\alpha, \beta)$  metric on a manifold  $M$  of dimension  $n \geq 3$ . Then the necessary and sufficient conditions for  $F$  to be locally dually flat on  $M$  are the following:*

- (1)  $s_{10} = \frac{1}{3}(\beta\theta_l - \theta b_l)$ ;
- (2)  $r_{00} = \frac{2}{3}\theta\beta + \left[ \tau + \frac{2}{3}(b^2\tau - \theta_l b^l) \right] \alpha^2 + \frac{1}{3}(25 - 30b^2)\tau\beta^2$ ;
- (3)  $G^l_\alpha = \frac{1}{3}[2\theta + 25\tau\beta]y^l + \frac{1}{3}(\theta^l\tau b^l)\alpha^2 + 5\tau\beta^2 b^l$ ;

where  $\tau = \tau(x)$  is a scalar function,  $\theta = \theta_k y^k$  is an 1-form on  $M$ .

*Proof* For a Finsler metric  $F = \alpha + \beta + \frac{\beta^2}{\alpha} + \frac{\beta^3}{\alpha^2}$  we obtain  $k_1 = 3, k_2 = 9, k_3 = 10$ , and

$$\phi = 1 + s + s^2 + s^3, \phi' = 1 + 2s + 3s^2, \phi'' = 2 + 6s, \phi''' = 6,$$

$$\begin{aligned} \Pi &= \frac{3 + 12s + 18s^2 + 20s^3 + 13s^4}{1 + s - 2s^3 - 3s^4 - 3s^5 - 2s^6}, \\ \Pi(0) &= 3, \quad \Pi'(0) = 9, \quad \Pi''(0) = 18, \quad \Pi'''(0) = 102. \\ Q &= \frac{1 + 2s + 3s^2}{1 - s^2 - 2s^3}, \quad Q' = \frac{2 + 8s + 8s^2 + 8s^3 + 6s^4}{(-1 + s^2 + 2s^3)^2}, \\ Q'' &= \frac{-8(1 + 8s + 9s^2 + 15s^3 + 9s^4 + 6s^5 + 3s^6)}{(-1 + s^2 + 2s^3)^3}, \\ Q(0) &= 1, \quad Q'(0) = 2, \quad Q''(0) = 8, \quad Q'''(0) = 24. \end{aligned}$$

By using the above values in Lemma 2.1, we get

$$[s(k_2 - k_3 s^2)(\phi\phi' - s\phi'^2 - s\phi\phi'') - (\phi'^2 + \phi\phi'') + k_1\phi(\phi - s\phi')] = 0 \quad \text{and} \quad \tau = 0.$$

Then, finally, by substituting  $k_1, k_2$  and  $k_3$  in Lemma 2.1, we infer the claim.

Now, let  $\phi = \phi(s)$  be a positive  $C^\infty$  function on  $(-b_0, b_0)$ . For a number  $b \in [0, b_0]$ , let

$$\Phi = -(Q - sQ')(n\Delta + 1 + sQ) - (b^2 - s^2)(1 + sQ)Q'', \quad (3.1)$$

where  $\Delta = 1 + sQ + (b^2 - s^2)Q'$ . This implies that

$$\Delta = \frac{\phi[1 - 3s^2 - 8s^3 + 2b^2(6 + 2s)]}{(-1 + s^2 + 2s^3)^2}.$$

Then, the equation (3.1) can be written as follows:

$$\Phi = -(Q - sQ')(n + 1)\Delta + (b^2 - s^2)\{(Q - sQ')Q' - (1 + sQ)Q''\}.$$

By using Theorem 2.3, now we will consider a locally dually flat  $(\alpha, \beta)$ -metric with isotropic

S-curvature.

**Theorem 3.2** *Let  $F = \alpha + \beta + \frac{\beta^2}{\alpha} + \frac{\beta^3}{\alpha^2}$  be a locally dually flat non-Randers type  $(\alpha, \beta)$ -metric on a manifold  $M$  of dimension  $n \geq 3$ . Suppose that  $F$  is of isotropic  $S$  curvature  $S = (n+1)cF$ , where  $c = c(x)$  a scalar function is on  $M$ . Then  $F$  is a locally projectively flat in adapted coordinate system and  $G^i = 0$ .*

*Proof* Let  $G^i = G^i(x, y)$  and  $\overline{G}_\alpha^i = \overline{G}_\alpha^i(x, y)$  denote the coefficients of  $F$  and  $\alpha$  respectively, in the same coordinate system. By definition, we have

$$G^i = G_\alpha^i + Py^i + Q^i, \quad (3.2)$$

where

$$P = \alpha^{-1}\Theta - 2Q\alpha s_o + r_{00}, \quad (3.3)$$

$$Q^i = \alpha Q s_o^i + \psi - 2Q\alpha s_o + r_{00}b^i, \quad (3.4)$$

$$\Theta = \frac{\phi\phi' - s(\phi\phi'' + \phi'\phi')}{2\phi((\phi - s\phi') + (b^2 - s^2)\phi'')} = \frac{-1 + s + 12s^2 + 20s^3 + 21s^4 + 3s^5}{2\phi[-1 + 2s^2 + 3s^3 - 2b^2(1 + 2s)]}$$

$$\psi = \frac{1}{2} \frac{\phi''}{((\phi - s\phi') + (b^2 - s^2)\phi'')} = \frac{1 + 3s}{1 - 3s^2 - 8s^3 + b^2(2 + 6s)}$$

First, we suppose that case (i) of Theorem 2.3 holds. It is remarkable that, for a special Finsler  $(\alpha, \beta)$  metric, we have

$$\Delta = \frac{\phi[1 - 3s^2 - 8s^3 + 2b^2(6 + 2s)]}{(-1 + s^2 + 2s^3)^2}$$

It follows that  $(-1 + s^2 + 2s^3)^2\Delta$  is a polynomial in  $s$  of degree 3. On the other hand we have

$$\phi\Delta^2 = \frac{\phi^2[1 - 3s^2 - 8s^3 + 2b^2(6 + 2s)]^2}{(-1 + s^2 + 2s^3)^4}. \quad (3.5)$$

Hence, if case (2) of Theorem (2.3) holds, then substituting (3.5) we obtain that

$$(b^2 - s^2)(-1 + s^2 + 2s^3)^4\Phi = -2(n+1)k\phi^2[1 - 3s^2 - 8s^3 + 2b^2(6 + 2s)]^2. \quad (3.6)$$

It follows that  $(b^2 - s^2)(-1 + s^2 + 2s^3)^4\Phi$  is not a polynomial in  $s$  (if  $k = 0$ , then by considering the Cartan torsion equation, we get a contradiction). Then, we put

$$\phi\Delta^2 = \frac{\overline{\Delta}}{(-1 + s^2 + 2s^3)^4},$$

where

$$\overline{\Delta} = \phi^2[1 - 3s^2 - 8s^3 + 2b^2(6 + 2s)]^2.$$

By assumption,  $F$  is a non-Randers type metric. Thus  $\overline{\Delta}$  is not a polynomial in  $s$ , and then

$(b^2 - s^2)(-1 + s^2 + 2s^3)^4\Phi$  is not a polynomial in  $s$ . Now, let us consider another form of  $\Phi$

$$\Phi = -(Q - sQ')(n+1)\Delta + (b^2 - s^2)\{(Q - sQ')Q' - (1 + sQ)Q''\},$$

where

$$Q - sQ' = \frac{(1 - 6s^2 - 12s^3 - 15s^4 - 12s^5)}{(-1 + s^2 + 2s^3)^2}.$$

Then,

$$\begin{aligned} \Phi &= \frac{-1}{(-1 + s^2 + 2s^3)^4} \{ \Phi[1 - 15s^2 - 38s^3 - 81s^4 - 108s^5 - 33s^6 - 6s^7 \\ &\quad + n(-1 - 9s^2 - 20s^3 + 3s^4 + 72s^5 + 141s^6 + 156s^7 + 96s^8) \\ &\quad + 2b^2(4(1 + 3s + 9s^2 + 15s^3 + 9s^4 + 6s^5 + 3s^6) \\ &\quad - n(-1 - 3s + 6s^2 + 30s^3 + 51s^4 + 57s^5 + 36s^6))] \}. \end{aligned} \quad (3.7)$$

From equations (3.6) and (3.7), the relation  $(b^2 - s^2)(-1 + s^2 + 2s^3)^4\Phi$  is a polynomial in  $s$  and  $b$  of degree 8 and 4 respectively. The coefficient of  $s^8$  is not equal to zero. Hence it is impossible that  $\Phi = 0$ . Therefore, we can conclude that equation (2.2) does not hold. So, the case (ii) of Theorem 2.3 holds. In this case, we have

$$r_{00} = 0, s_j = 0.$$

In Theorem 3.1(2), by taking  $r_{00} = 0$ , we obtain (3.8)

$$\left[ \tau + \frac{2}{3}(b^2\tau - \theta_l b^l) \right] \alpha^2 = \frac{1}{3}\beta[-2\Theta - (25 + 30b^2)\beta\tau]. \quad (3.8)$$

Since  $\alpha^2$  is an irreducible polynomial of  $y^i$ , equation (3.8) reduces to the following

$$\tau + \frac{2}{3}(b^2\tau - b_m\theta^m) = 0, \quad (3.9)$$

$$\frac{2}{3}\theta + \frac{1}{3}(25 + 30b^2)\beta\tau = 0, \quad (3.10)$$

where

$$\theta = -\frac{1}{2}(25 + 30b^2)\beta\tau. \quad (3.11)$$

Then, Theorem 3.1(1) yields

$$s_0 = -\frac{1}{3(b^2\tau - \beta b_m\theta^m)}$$

This implies

$$(b^2\tau - \beta b_m\theta^m) = 0$$

From (3.8), (3.9) and (3.11), we obtain

$$\theta = -\frac{1}{2}(25 + 30b^2)\beta\tau. \quad (3.12)$$

From equations (3.9) and (3.12), it follows that  $\tau = 0$  and substituting  $\tau = 0$  in equation (3.12), we get  $\theta = 0$ . Thus finally (1), (2) and (3) reduce to the following

$$s_{ij} = 0, \quad G_{\alpha}^l = 0, \quad r_{00} = 0.$$

Since  $s_0 = r_{00} = 0$ , then equations (3.3) and (3.4) reduce to

$$P = 0 \quad \text{and} \quad Q^i = 0.$$

Then the relation (3.2) becomes  $G_{\alpha}^l = 0$ , which completes the proof.  $\square$

**Theorem 3.3** *Let  $F = \alpha + \beta + \frac{\beta^2}{\alpha} + \frac{\beta^3}{\alpha^2}$  be a non-Riemannian metric on  $n$ -dimensional  $n \geq 3$  manifold  $M$ . Then  $F$  is locally dually flat with isotropic  $S$ -curvature. Moreover,  $S = (n + 1)CF$  if and only if the structure is locally Minkowskian.*

*Proof* From Theorem 3.2 we have that  $F = \alpha + \beta + \frac{\beta^2}{\alpha} + \frac{\beta^3}{\alpha^2}$  is dually flat and projectively flat in any adapted coordinate system. By Lemma 2.1, we infer

$$F_{x^k} = CF_{y^k}.$$

Hence the spray coefficients  $G^i = Py^i$  are given by  $P = \frac{1}{2}CF$ . Since  $G^i = 0$ , then  $P = 0$ , and hence  $C = 0$ . This implies that  $F_{x^k}$  and then  $F$  is a locally Minkowskian metric in the adapted coordinate system.  $\square$

#### §4. Conclusions

The authors S. I. Amari and H. Nagaoka ([2]) introduced the notion of dually flat Riemannian metrics, while studying information geometry on Riemannian manifolds. Information geometry emerged from investigating the geometrical structure of a family of probability distributions and was successfully applied to various areas, including statistical inference, control system theorem and multi-terminal information theorem. As known, Finsler geometry is just Riemannian geometry without the quadratic restriction. Therefore, it is natural to extend the construction of locally dually flat metrics to Finsler geometry. In Finsler geometry, Z. Shen [7] extended the notion of locally dually flat metric in Finsler information geometry, which plays a very important role in studying many applications in Finsler information structures. In this article, we study and characterize the locally dually flat a special  $(\alpha, \beta)$  metric  $F = \alpha + \beta + \frac{\beta^2}{\alpha} + \frac{\beta^3}{\alpha^2}$  with isotropic  $S$ -curvature which is not Riemannian.

#### References

- [1] S.K.Narasimhamurthy, A.R.Kavyashree and Y.K.Mallikarjun : Characterization of locally dually flat first approximate Matsumoto metric, *Balkan Journal of Geometry and Its Applications*, Vol.19. No.1 (80 -87) 2014.



- [2] S. I. Amari and H., *Methods of Information Geometry*, Oxford University Press, AMS Translations of Math. Monographs 191, (2000).
- [3] S. Bacsó, X. Cheng and Z. Shen : Curvature properties of  $(\alpha, \beta)$ -metrics, in: *Finsler Geometry, Sapporo 2005 - In Memory of Makoto Matsumoto*, Ed. S. Sabau and H. Shimada, *Adv. Stud. Pure Math.*, 48, Math. Soc. Japan, 2007, 73-110.
- [4] X. Cheng, Z. Shen and Y. Zhou, on a class of locally dually flat Finsler metrics, *J. Math.* 21, 11(2005), 1-13.
- [5] X.Cheng and Y. Tian : Locally dually flat Finsler metrics with special curvature properties, *J. Di.Geom. Appl.*, 29, Supplement 1, August 2011, S98-S106.
- [6] S. K. Narasimhamurthy, A. R. Kavyashree and M. Y. Kumbar: On a class of weakly Berwald  $(\alpha, \beta)$ -Metrics of scalar flag curvature, *Int. J. Math. Res.*, 5 (2013), 97-108.
- [7] Z. Shen, Riemann-Finsler geometry with applications to information geometry, *J. Chin. Ann.Math.*, 27B (1) (2006), 73-94.
- [8] Z.Shen, Volume comparison and its applications in Riemann-Finsler geometry, *J. Adv. in Math.*, 128 (1997), 306-328.
- [9] Q. Xia, On locally dually flag  $(\alpha, \beta)$ -metrics, *J.0 Di. Geom. Appl.*, 29 (2) (2011), 233-243.
- [10] Q. Xia: On a class of locally dually at Finsler metrics of isotropic flag curvature, *J. Publ. Math. Debrecen.*, 78 (1) (2011), 169-190.
- [11] Q. Xia: On a class of locally dually flat Finsler metrics of scalar flag curvature, *J. Publ. Math.Debrecen*, in press.

# Gröbner-Shirshov Bases Theory for the Right Ideals of Left-Commutative Algebras

Yu Li

(Department of Mathematics, Huizhou University, Huizhou 516007, P. R. China)

E-mail: liyu820615@126.com

**Abstract:** In this paper, we establish a Composition-Diamond lemma for the right ideals of free left-commutative algebras. As an application, we prove that the membership problems for the right ideals of free left-commutative algebras are decidable.

**Key Words:** Basis, Gröbner-Shirshov basis, left-commutative algebras.

**AMS(2010):** 16S15, 17A50

## §1. Introduction

Gröbner bases and Gröbner-Shirshov bases were invented independently by A.I. Shirshov for ideals of free (commutative, anti-commutative) non-associative algebras [33, 35] (see also [9, 10]), free Lie algebras [34, 35] and implicitly free associative algebras [34, 35] (see also [3, 4]), by H. Hironaka [30] for ideals of the power series algebras (both formal and convergent), and by B. Buchberger [20] for ideals of the polynomial algebras.

Gröbner bases and Gröbner-Shirshov bases theories have been proved to be very useful in different branches of mathematics, including commutative algebra and combinatorial algebra, see, for example, the books [1, 19, 21, 22, 26, 28], the papers [2, 3, 4], and the surveys [5, 6, 14, 16, 17, 18].

Up to now, different versions of Composition-Diamond lemma are known for the following classes of algebras apart those mentioned above: Lie  $p$ -algebras [32], associative conformal algebras [15], modules [25, 31] (see also [24]), right-symmetric algebras [8], dialgebras [11], associative algebras with multiple operators [13], matabelian Lie algebras [23], Rota-Baxter algebras [7], semirings [12], integro-differential algebras [29], and so on.

Let  $k$  be a field,  $A$  a non-associative algebra over  $k$ . We call  $A$  a left-commutative algebra over  $k$ , if  $A$  satisfies the following identity:  $x(yz) = y(xz)$ ,  $x, y, z \in A$ . The variety of Novikov algebras and the variety of dual Leibniz algebras are subvarieties of the variety of left-commutative algebras. Free left-commutative algebras were firstly studied by A. Dzhu-

---

<sup>1</sup>Supported by the NNSF of China No.11401246, 11426112 and 11501237, the NSF of Guangdong Province No.2014A030310087, 2014A030310119 and 2016A030310099, the Foundation for Distinguished Young Teachers in Higher Education of Guangdong No.YQ2015155, and the Research Fund for the Doctoral Program of Huizhou University No.C513.0210, C513.0209.

<sup>2</sup>Received April 27, 2016, Accepted November 10, 2016.

madil'daev and C. Löfwall [27]. They constructed a monomial basis for free left-commutative algebras. In this paper, we establish Gröbner-Shirshov bases theory for the right ideals of left-commutative algebras. Using this theory, we prove the decidability of the membership problems for the right ideals of free left-commutative algebras.

## §2. Free Left-Commutative Algebras

Let  $X$  be a well ordered set. Each letter  $x_i \in X$  is called a non-associative word of degree 1. Suppose that  $u$  is a non-associative word of degree  $m$  and  $v$  is a non-associative word of degree  $n$ . Then  $(uv)$  is called a non-associative word of degree  $m + n$ . Denote by  $d(u)$  the degree of the non-associative word  $u$ .

Let  $u, v \in X^{**}$  be non-associative words. Then we say that  $u > v$  if  $d(u) > d(v)$ . If  $d(u) = d(v) \geq 2$  and  $u = (u_1u_2), v = (v_1v_2)$ , then we say that  $u > v$  if either  $u_2 > v_2$  or  $u_2 = v_2$  and  $u_1 > v_1$ . This ordering is called non-associative degree inverse lexicographic ordering. Unless otherwise stated, the non-associative degree inverse lexicographic ordering is used throughout this paper.

**Definition 2.1** *Each letter  $x_i \in X$  is called a regular word of degree 1. Suppose that  $u = (vw)$  is a non-associative word of degree  $m, m > 1$ . Then  $u = (vw)$  is called a regular word of degree  $m$  if it satisfies the following conditions:*

- (S1) *both  $v$  and  $w$  are regular words, and*
- (S2) *if  $w = (w_1w_2)$ , then  $v \geq w_1$ .*

Let  $k$  be a field,  $N(X)$  the set of all regular words on  $X$ ,  $kN(X)$  the  $k$ -linear space spanned by  $N(X)$ . Let  $u, v \in N(X)$ . Then we define a product  $u \cdot v$  on  $kN(X)$  by the following way: if  $v = x_i \in X$ , then  $u \cdot v := (ux_i)$ ; if  $v = (v_1v_2)$  and  $u \geq v_1$ , then  $u \cdot v := (u(v_1v_2))$ ; if  $v = (v_1v_2)$  and  $u < v_1$ , then  $u \cdot v := (v_1(u \cdot v_2))$ .

**Theorem 2.2**([27]) *Let  $LC(X)$  be the free left-commutative algebra generated by  $X$ . Then the algebra  $kN(X)$  is isomorphic to  $LC(X)$ .*

According to Theorem 2.2, each non-zero element  $f$  in  $LC(X)$  can be uniquely presented as

$$f = \alpha_1 u_1 + \alpha_2 u_2 + \dots + \alpha_m u_m,$$

where  $\alpha_i \in k$ ,  $u_i \in N(X)$  for all  $i$ ,  $\alpha_1 \neq 0$ ,  $u_1 > u_2 > \dots > u_m$ . Here, the regular word  $u_1$  is called the leading term of  $f$ , denoted by  $\bar{f}$  and  $\alpha_1$  the leading coefficient of  $f$ , denoted by  $\alpha_{\bar{f}}$ . If  $\alpha_{\bar{f}} = 1$ , then  $f$  is called a monic polynomial.

For every  $f \in LC(X)$  denote by  $L_f$  the operator of left multiplication by  $f$  acting on  $LC(X)$ , i.e.,  $L_f(g) = fg$  for all  $g \in LC(X)$ . In particular, if  $f_1, f_2, \dots, f_m, g \in LC(X)$ , then  $L_{f_m} \dots L_{f_2} L_{f_1}(g) = (f_m(\dots(f_2(f_1g))\dots))$ .

**Lemma 2.3**([27]) *Let  $u \in N(X)$  be a regular word. Then  $u$  can be uniquely presented as*

$$u = L_{u_n} \dots L_{u_1}(x_i),$$

where  $x_i \in X$ ,  $u_n \geq \dots \geq u_1, u_j \in N(X), 1 \leq j \leq n, n \geq 0$ .

**Lemma 2.4** *Let  $u, v \in N(X)$  be regular words and  $v = L_{v_n} \dots L_{v_1}(x_i)$ , where  $n \geq 1, x_i \in X$ . Then*

$$u \cdot v = L_{v_n} \dots L_{v_t} L_u L_{v_{t-1}} \dots L_{v_1}(x_i),$$

where  $v_n \geq \dots \geq v_t > u \geq v_{t-1} \geq \dots \geq v_1$ .

*Proof* Let us use induction on  $n$ . If  $n = 1$  and  $u \geq v_1$ , then  $u \cdot v = L_u L_{v_1}(x_i)$ . If  $n = 1$  and  $u < v_1$ , then  $u \cdot v = L_{v_1} L_u(x_i)$ . Suppose that  $n > 1$ . If  $u \geq v_n$ , then  $u \cdot v = L_u L_{v_n} \dots L_{v_1}(x_i)$ . If  $u < v_n$ , then  $u \cdot v = v_n(u \cdot L_{v_{n-1}} \dots L_{v_1}(x_i))$ . By the inductive hypothesis,  $u \cdot L_{v_{n-1}} \dots L_{v_1}(x_i) = L_{v_{n-1}} \dots L_{v_t} L_u L_{v_{t-1}} \dots L_{v_1}(x_i)$ , where  $v_{n-1} \geq \dots \geq v_t > u \geq v_{t-1} \geq \dots \geq v_1$ . Therefore,

$$u \cdot v = L_{v_n} \dots L_{v_t} L_u L_{v_{t-1}} \dots L_{v_1}(x_i),$$

where  $v_n \geq \dots \geq v_t > u \geq v_{t-1} \geq \dots \geq v_1$ . □

**Lemma 2.5**([27]) *If  $u, v, w \in N(X)$  and  $u > v$ , then  $u \cdot w > v \cdot w, w \cdot u > w \cdot v$ .*

From Lemma 2.5, it follows that

**Corollary 2.6** *If  $f, g \in LC(X)$ , then  $\overline{(f \cdot g)} = \overline{(f \cdot \overline{g})}$ .*

### §3. Composition-Diamond Lemma for Right Ideals of Free Left-Commutative Algebras

**Definition 3.1** *Let  $S \subset LC(X)$  be a set of monic polynomials. Each polynomial  $s \in S$  is called an  $S$ -word of  $s$ -length one. Suppose that  $(u)_s$  is an  $S$ -word of  $s$ -length  $m$  and  $v$  is a regular word of degree  $n$ . Then  $(u)_s \cdot v$  is an  $S$ -word of  $s$ -length  $m + n$ .*

**Definition 3.2** *Let  $S \subset LC(X)$  be a set of monic polynomials. Each polynomial  $s \in S$  is called a normal  $S$ -word of  $s$ -length one. Suppose that  $(u)_s$  is a normal  $S$ -word of  $s$ -length  $m$  and  $x_i \in X, v_j \in N(X), 1 \leq j \leq n, 0 \leq n$ . Then  $L_{v_n} \dots L_{v_t} L_{(u)_s} L_{v_{t-1}} \dots L_{v_1}(x_i)$  is called a normal  $S$ -word of  $s$ -length  $m + 1 + \sum_j d(v_j)$  if  $v_n \geq \dots \geq v_t > (u)_s \geq v_{t-1} \geq \dots \geq v_1$ . We denote  $(u)_s$  by  $[u]_s$  if  $(u)_s$  is a normal  $S$ -word.*

**Lemma 3.3** *For each  $S$ -word  $(u)_s$ , there exists a normal  $S$ -word  $[v]_s$  such that  $(u)_s = [v]_s$ .*

*Proof* Suppose that the  $s$ -length of  $(u)_s$  is  $m$ . Let us use induction on  $m$ . If  $m = 1$ , then  $(u)_s = s$  and the lemma holds clearly. Suppose that  $(u)_s = (v)_s \cdot w$ , where  $w \in N(X)$  and  $(v)_s$  is an  $S$ -word with  $s$ -length less than  $m$ . By the induction hypothesis, there exists a normal  $S$ -word  $[v']_s$  such that  $(v)_s = [v']_s$ . If  $w = x_i \in X$ , then the lemma holds clearly. Let us assume

that  $w = L_{w_l} \cdots L_{w_1}(x_i)$ , where  $x_i \in X$ ,  $w_l \geq \cdots \geq w_1, w_j \in N(X), 1 \leq j \leq l, 1 \leq l$ . Then by Lemma 2.4 we have

$$(u)_s = (v)_s \cdot w = [v']_s \cdot w = L_{w_l} \cdots L_{w_t} L_{[v']_s} L_{w_{t-1}} \cdots L_{w_1}(x_i),$$

where  $w_l \geq \cdots \geq w_t > \overline{[v']_s} \geq w_{t-1} \geq \cdots \geq w_1$ . This completes our proof.  $\square$

From Corollary 2.6, it follows that  $\overline{[u]_s} = [u]_{\overline{s}}$ .

**Definition 3.4** Let  $f, g$  be monic polynomials in  $LC(X)$ . If there exists a normal  $g$ -word  $[u]_g$  such that  $\bar{f} = \overline{[u]_g}$ , then the polynomial  $f - [u]_g$  is called a composition of inclusion of  $f$  and  $g$ , and denoted by  $(f, g)_{\bar{f}}$ .

Let  $S$  be a given nonempty subset of  $LC(X)$ . The composition of inclusion  $(f, g)_{\bar{f}}$  is said to be trivial modulo  $(S, \bar{f})$  if

$$(f, g)_{\bar{f}} = \sum_i \alpha_i [u_i]_{s_i},$$

where  $\alpha_i \in k$ ,  $s_i \in S$ ,  $[u_i]_{s_i}$  are normal  $S$ -words and  $\overline{[u_i]_{s_i}} < \bar{f}$ . If this is the case, then we write

$$(f, g)_{\bar{f}} \equiv 0 \pmod{(S, \bar{f})}.$$

In general, for any regular word  $w$  and  $f, g \in LC(X)$ , we write

$$f \equiv g \pmod{(S, w)}$$

which means that  $f - g = \sum \alpha_i [u_i]_{s_i}$ , where  $\alpha_i \in k$ ,  $s_i \in S$  and  $\overline{[u_i]_{s_i}} < w$ .

**Definition 3.5** Let  $S \subset LC(X)$  be a nonempty set of monic polynomials and  $Id_r(S)$  the right ideal of  $LC(X)$ , generated by  $S$ . Then the set  $S$  is called a Gröbner-Shirshov basis for  $Id_r(S)$  if any composition of inclusion in  $S$  is trivial modulo  $S$ .

**Lemma 3.6** Let  $[u_1]_{s_1}, [u_2]_{s_2}$  be normal  $S$ -words. If  $S$  is a Gröbner-Shirshov basis for  $Id_r(S)$  and  $w = \overline{[u_1]_{s_1}} = \overline{[u_2]_{s_2}}$ , then

$$[u_1]_{s_1} \equiv [u_2]_{s_2} \pmod{(S, w)}.$$

*Proof* If  $[u_1]_{s_1} = s_1$  or  $[u_2]_{s_2} = s_2$ , then the lemma holds since  $S$  is a Gröbner-Shirshov basis for  $Id_r(S)$ .

Suppose that

$$[u_1]_{s_1} = L_{v_l} \cdots L_{v_p} L_{[v]_{s_1}} L_{v_{p-1}} \cdots L_{v_1}(x_i),$$

$$[u_2]_{s_2} = L_{w_m} \cdots L_{w_q} L_{[w]_{s_2}} L_{w_{q-1}} \cdots L_{w_1}(x_j),$$

where  $v_l \geq \cdots \geq v_p > \overline{[v]_{s_1}} \geq v_{p-1} \geq \cdots \geq v_1$  and  $w_m \geq \cdots \geq w_q > \overline{[w]_{s_2}} \geq w_{q-1} \geq \cdots \geq w_1$ . From  $\overline{[u_1]_{s_1}} = \overline{[u_2]_{s_2}}$  and Lemma 2.3, it follows that  $x_i = x_j, l = m$  and either  $p = q, v_1 = w_1, v_2 = w_2, \cdots, v_l = w_l, \overline{[v]_{s_1}} = \overline{[w]_{s_2}}$  or  $p \neq q$ , (Here without loss of generality we may assume  $p > q$ ),  $v_1 = w_1, v_2 = w_2, \cdots, v_{q-1} = w_{q-1}, v_q = \overline{[w]_{s_2}}, v_{q+1} = w_q, \cdots, v_{p-1} = w_{p-2}, \overline{[v]_{s_1}} =$

$w_{p-1}, v_p = w_p, \dots, v_l = w_l$ .

If  $p = q$ ,  $v_1 = w_1, v_2 = w_2, \dots, v_l = w_l, \overline{[v]_{s_1}} = \overline{[w]_{s_2}}$ , then

$$[u_1]_{s_1} - [u_2]_{s_2} = L_{v_l} \cdots L_{v_p} L_{([v]_{s_1} - [w]_{s_2})} L_{v_{p-1}} \cdots L_{v_1}(x_i).$$

By induction on  $w$ ,  $[v]_{s_1} \equiv [w]_{s_2} \pmod{S, \overline{[v]_{s_1}}}$ . From Lemma 3.3, it follows that  $[u_1]_{s_1} \equiv [u_2]_{s_2} \pmod{S, w}$ .

Suppose that  $p > q$ ,  $v_1 = w_1, v_2 = w_2, \dots, v_{q-1} = w_{q-1}, v_q = \overline{[w]_{s_2}}, v_{q+1} = w_q, \dots, v_{p-1} = w_{p-2}, \overline{[v]_{s_1}} = w_{p-1}, v_p = w_p, \dots, v_l = w_l$ . Then

$$\begin{aligned} [u_1]_{s_1} - [u_2]_{s_2} &= L_{v_l} \cdots L_{v_p} L_{[v]_{s_1}} L_{v_{p-1}} \cdots L_{v_{q+1}} L_{v_q} L_{v_{q-1}} \cdots L_{v_1}(x_i) \\ &\quad - L_{v_l} \cdots L_{v_p} L_{[v]_{s_1}} L_{v_{p-1}} \cdots L_{v_{q+1}} L_{[w]_{s_2}} L_{v_{q-1}} \cdots L_{v_1}(x_i) \\ &\quad + L_{v_l} \cdots L_{v_p} L_{[v]_{s_1}} L_{v_{p-1}} \cdots L_{v_{q+1}} L_{[w]_{s_2}} L_{v_{q-1}} \cdots L_{v_1}(x_i) \\ &\quad - L_{v_l} \cdots L_{v_p} L_{w_{p-1}} L_{v_{p-1}} \cdots L_{v_{q+1}} L_{[w]_{s_2}} L_{v_{q-1}} \cdots L_{v_1}(x_i) \\ &= L_{v_l} \cdots L_{v_p} L_{([v]_{s_1} - w_{p-1})} L_{v_{p-1}} \cdots L_{v_{q+1}} L_{[w]_{s_2}} L_{v_{q-1}} \cdots L_{v_1}(x_i) \\ &\quad - L_{v_l} \cdots L_{v_p} L_{[v]_{s_1}} L_{v_{p-1}} \cdots L_{v_{q+1}} L_{([w]_{s_2} - v_q)} L_{v_{q-1}} \cdots L_{v_1}(x_i). \end{aligned}$$

Since  $\overline{[v]_{s_1}} - w_{p-1}, \overline{[w]_{s_2}} - v_q < w$ , by Lemmas 2.5 and 3.3, we conclude that

$$[u_1]_{s_1} \equiv [u_2]_{s_2} \pmod{S, w}.$$

This completes our proof.  $\square$

**Theorem 3.7** *Let  $S \subset LC(X)$  be a nonempty set of monic polynomials,  $N(X)$  the set of all regular words on  $X$  and  $<$  the non-associative degree inverse lexicographic ordering on  $N(X)$ . Let  $Id_r(S)$  be the right ideal of  $LC(X)$  generated by  $S$ . Then the following statements are equivalent:*

- (i)  $S$  is a Gröbner-Shirshov basis for  $Id_r(S)$ ;
- (ii)  $f \in Id_r(S) \Rightarrow \overline{f} = [u]_{\overline{s}}$  for some  $s \in S$ , where  $[u]_s$  is a normal  $S$ -word;
- (iii)  $f \in Id_r(S) \Rightarrow f = \alpha_1 [u_1]_{s_1} + \alpha_2 [u_2]_{s_2} + \cdots$ , where  $\alpha_i \in k$ ,  $\overline{[u_1]_{s_1}} > \overline{[u_2]_{s_2}} > \cdots$ , and  $[u_i]_{s_i}$  are normal  $S$ -words.

*Proof* (i)  $\Rightarrow$  (ii). Let  $S$  be a Gröbner-Shirshov basis and  $0 \neq f \in Id_r(S)$ . We may assume, by Lemma 3.3, that

$$f = \sum_{i=1}^n \alpha_i [u_i]_{s_i},$$

where  $\alpha_i \in k$ , and  $[u_i]_{s_i}$  are normal  $S$ -words. Let

$$w_i = \overline{[u_i]_{s_i}}, w_1 = w_2 = \cdots = w_l > w_{l+1} \geq \cdots.$$

We will use the induction on  $l$  and  $w_1$  to prove that  $\overline{f} = \overline{[u]_s}$  for some normal  $S$ -word  $[u]_s$ .

If  $l = 1$ , then  $\bar{f} = \overline{[u_1]_{s_1}}$  and hence the statement holds. Assume that  $l \geq 2$ . Then

$$\alpha_1[u_1]_{s_1} + \alpha_2[u_2]_{s_2} = (\alpha_1 + \alpha_2)[u_1]_{s_1} - \alpha_2([u_1]_{s_1} - [u_2]_{s_2})$$

and by Lemma 3.6, we have

$$[u_1]_{s_1} \equiv [u_2]_{s_2} \pmod{S, [w_1]}.$$

Thus, if  $\alpha_1 + \alpha_2 \neq 0$  or  $l > 2$ , the result follows from the induction on  $l$ . For the case that  $\alpha_1 + \alpha_2 = 0$  and  $l = 2$ , we shall use induction on  $w_1$  and then the result follows.

(ii)  $\Rightarrow$  (iii). Assume that (ii) and  $0 \neq f \in Id_r(S)$ . Let  $f = \alpha_1 \bar{f} + \dots$ . Then, by (ii),  $\bar{f} = \overline{[u_1]_{s_1}}$ . Therefore,

$$f_1 = f - \alpha_1[u_1]_{s_1}, \quad \bar{f}_1 < \bar{f}, \quad f_1 \in Id_r(S).$$

Now, by using induction on  $\bar{f}$ , we have (iii).

(iii)  $\Rightarrow$  (i). Suppose that  $(f, g)_{\bar{f}} = f - [u]_g$  is a composition of inclusion of  $f$  and  $g$ ,  $f, g \in S$ . It is clear that  $(f, g)_{\bar{f}} \in Id_r(S)$ . Then, by (iii), we have  $(f, g)_{\bar{f}} = \alpha_1[u_1]_{s_1} + \alpha_2[u_2]_{s_2} + \dots$ , where  $\alpha_i \in k$ ,  $\bar{f} > (f, g)_{\bar{f}} = \overline{[u_1]_{s_1}} > \overline{[u_2]_{s_2}} > \dots$ . This completes the proof.  $\square$

**Theorem 3.8** *The membership problems for the right ideals of free left-commutative algebras are decidable.*

*Proof* Let  $X$  be a finite set and  $N(X)$  all regular words on  $X$ . Let

$$T = \{(u_1, u_2, \dots, u_l) \mid u_i \in N(X), u_1 \geq u_2 \geq \dots \geq u_l, 1 \leq l\}.$$

For  $(u_1, u_2, \dots, u_p), (v_1, v_2, \dots, v_q) \in T$ , we define  $(u_1, u_2, \dots, u_p) > (v_1, v_2, \dots, v_q)$  if either  $p > q$  or  $p = q$  and  $(u_1, u_2, \dots, u_p) > (v_1, v_2, \dots, v_q)$  lexicographically. Clearly, this ordering is a well ordering on  $T$ .

Let  $S = \{f_1, \dots, f_m\} \in LC(X)$ ,  $1 \leq m$ . Let us assume that  $\bar{f}_1 \geq \bar{f}_2 \geq \dots \geq \bar{f}_m$ . Then we set  $\psi(S) = (\bar{f}_1, \bar{f}_2, \dots, \bar{f}_m)$ . If there exists a composition of inclusion  $(f_i, f_j)_{\bar{f}_i}$  of  $f_i$  and  $f_j$ ,  $i < j$ , then we replace  $f_i$  by  $(f_i, f_j)_{\bar{f}_i}$  and then we obtain a new set  $S_1$ . Clearly,  $Id_r(S) = Id_r(S_1)$  and  $\psi(S) > \psi(S_1)$ . Since the ordering on  $T$  is a well ordering, we may obtain a finite Gröbner-Shirshov basis  $S_c$  for the right ideal  $Id_r(S)$  of  $LC(X)$ .

Now, we show that the membership problem for the right ideal  $Id_r(S)$  is decidable. We may assume, without loss of generality, that  $S$  is a finite Gröbner-Shirshov basis for the right ideal  $Id_r(S)$ . For an element  $g \in LC(X)$ , if there is no normal  $S$ -word  $[u]_{f_i}$  such that  $\bar{g} = \overline{[u]_{f_i}}$ , then by Theorem 3.7 we may conclude that  $g \notin Id_r(S)$ . Otherwise, we let  $g_1 = g - [u]_{f_i}$ . Clearly,  $g \in Id_r(S)$  if and only if  $g_1 \in Id_r(S)$ . Since  $\bar{g}_1 < \bar{g}$ , we may complete the proof of this theorem by the induction on  $\bar{g}$ .  $\square$

## References

- [1] William W. Adams and Philippe Loustaunau, *An Introduction to Gröbner Bases*, Graduate Studies in Mathematics, Vol. 3, American Mathematical Society (AMS), 1994.

- [2] G.M. Bergman, The diamond lemma for ring theory, *Adv. Math.*, 29 (1978), 178-218.
- [3] L.A. Bokut, Insolvability of the word problem for Lie algebras, and subalgebras of finitely presented Lie algebras, *Izvestija AN USSR (mathem.)*, 36(6) (1972), 1173-1219.
- [4] L.A. Bokut, Imbeddings into simple associative algebras, *Algebra i Logika*, 15 (1976), 117-142.
- [5] L.A. Bokut and Y.Q. Chen, Gröbner-Shirshov bases: Some new results, *Proceedings of the Second International Congress in Algebra and Combinatorics*, World Scientific, 35-56, 2008.
- [6] L.A. Bokut and Y.Q. Chen, Gröbner-Shirshov bases and their calculation, *Bull. Math. Sci.* 4 (2014) 325-395.
- [7] L.A. Bokut, Y.Q. Chen and X.M. Deng, Gröbner-Shirshov bases for Rota-Baxter algebras, *Siberian Math. J.*, 51(6) (2010), 978-988.
- [8] L.A. Bokut, Y.Q. Chen and Y. Li, Gröbner-Shirshov bases for Vinberg-Koszul-Gerstenhaber right-symmetric algebras, *Fundamental and Applied Mathematics*, 14(8) (2008), 55-67 (in Russian). *J. Math. Sci.*, 166 (2010), 603-612.
- [9] L.A. Bokut, Y.Q. Chen and Y. Li, Anti-commutative Gröbner-Shirshov basis of a free Lie algebra, *Science in China*, 52(2)(2009), 244-253.
- [10] L.A. Bokut, Y.Q. Chen and Y. Li, Lyndon-Shirshov words and anti-commutative algebras, *Journal of Algebra*, 378 (2013), 173-183.
- [11] L.A. Bokut, Yuqun Chen and Cihua Liu, Gröbner-Shirshov bases for dialgebras, *International Journal of Algebra and Computation*, 20(3) (2010), 391-415.
- [12] L.A. Bokut, Y.Q. Chen and Q.H. Mo, Gröbner-Shirshov bases for semirings, *Journal of Algebra*, 385 (2013), 47-63.
- [13] L.A. Bokut, Y.Q. Chen and J.J. Qiu, Gröbner-Shirshov bases for associative algebras with multiple operators and free Rota-Baxter algebras, *Journal of Pure and Applied Algebra*, 214 (2010), 89-100.
- [14] L.A. Bokut, Y.Q. Chen and K.P. Shum, Some new results on Gröbner-Shirshov bases, in: *Proceedings of International Conference on Algebra 2010, Advances in Algebraic Structures*, 2012, pp.53-102.
- [15] L.A. Bokut, Y. Fong and W.-F. Ke, Composition-Diamond lemma for associative conformal algebras, *Journal of Algebra*, 272 (2004), 739-774.
- [16] L.A. Bokut, Y. Fong, W.-F. Ke and P.S. Kolesnikov, Gröbner and Gröbner-Shirshov bases in algebra and conformal algebras, *Fundamental and Applied Mathematics*, 6(3)(2000), 669-706.
- [17] L.A. Bokut and P.S. Kolesnikov, Gröbner-Shirshov bases: from their incipency to the present, *J. Math. Sci.*, 116(1) (2003), 2894-2916.
- [18] L.A. Bokut and P.S. Kolesnikov, Gröbner-Shirshov bases, conformal algebras and pseudo-algebras, *J. Math. Sci.*, 131(5) (2005), 5962-6003.
- [19] L.A. Bokut and G. Kukin, *Algorithmic and Combinatorial Algebra*, Kluwer Academic Publ., Dordrecht, 1994.
- [20] B. Buchberger, An algorithmical criteria for the solvability of algebraic systems of equations, *Aequationes Math.*, 4 (1970), 374-383.



- [21] B. Buchberger, G.E. Collins, R. Loos and R. Albrecht, *Computer algebra, symbolic and algebraic computation, Computing Supplementum*, Vol.4, New York: Springer-Verlag, 1982.
- [22] B. Buchberger and Franz Winkler, *Gröbner Bases and Applications*, London Mathematical Society Lecture Note Series, Vol.251, Cambridge: Cambridge University Press, 1998.
- [23] Y.S. Chen and Y.Q. Chen, Gröbner-Shirshov bases for matabelian Lie algebras, *Journal of Algebra*, 358(2012), 143-161.
- [24] Y.Q. Chen, Y.S. Chen and C.Y. Zhong, Composition-Diamond lemma for modules, *Czechoslovak Math. J.*, 60(135)(2010), 59-76.
- [25] E.S. Chibrikov, On free Lie conformal algebras, *Vestnik Novosibirsk State University*, 4(1) (2004), 65-83.
- [26] David A. Cox, John Little and Donal O'Shea, *Ideals, Varieties and Algorithms: An Introduction to Computational Algebraic Geometry and Commutative Algebra*, Undergraduate Texts in Mathematics, New York: Springer-Verlag, 1992.
- [27] A. Dzhumadil'daev and C. Löfwall, Trees, free right-symmetric algebras, free Novikov algebras and identities, *Homology, Homotopy and Applications*, 4 (2) (2002) 165-190.
- [28] David Eisenbud, *Commutative Algebra with a View Toward Algebraic Geometry*, Graduate Texts in Math., Vol.150, Berlin and New York: Springer-Verlag, 1995.
- [29] X. Gao, L. Guo and M. Rosenkranz, Free integro-differential algebras and Gröbner-Shirshov bases, *Journal of Algebra*, 442 (2015), 354-396.
- [30] H. Hironaka, Resolution of singularities of an algebraic variety over a field of characteristic zero, I, II, *Ann. of Math.*, 79 (1964), 109-203, 205-326.
- [31] S.-J. Kang and K.-H. Lee, Gröbner-Shirshov bases for irreducible  $sl_{n+1}$ -modules, *Journal of Algebra*, 232 (2000), 1-20.
- [32] A.A. Mikhalev, The composition lemma for color Lie superalgebras and for Lie  $p$ -superalgebras, *Contemp. Math.*, 131(2) (1992), 91-104.
- [33] A.I. Shirshov, Some algorithmic problem for  $\varepsilon$ -algebras, *Sibirsk. Mat. Z.*, 3(1962), 132-137.
- [34] A.I. Shirshov, Some algorithmic problem for Lie algebras, *Sibirsk. Mat. Z.*, **3**(2), 292-296 (1962) (in Russian). English translation: *SIGSAM Bull.*, 33(2)(1999), 3-6.
- [35] Selected works of A.I. Shirshov, Eds L.A. Bokut, V. Latyshev, I. Shestakov, E. Zelmanov, Trs M. Bremner, M. Kochetov, Birkhäuser, Basel.

## On the Riemann and Ricci Curvature of Finsler Spaces with Special $(\alpha, \beta)$ - Metric

Gauree Shanker

Centre for Mathematics and Statistics

School of Basic and Applied Statistics, Central University of Punjab, Bathinda, Punjab-151001, India

Sruthy Asha Baby

Department of Mathematics and Statistics, Banasthali University, Banasthali, Rajasthan-304022, India

E-mail: gsp.math.1978@gmail.com, sruthymuthu123@gmail.com

**Abstract:** In this paper, we study the curvature properties of the special  $(\alpha, \beta)$ - metric  $F = \alpha + \epsilon\beta + k\frac{\beta^2}{\alpha}$  (where  $\epsilon, k \neq 0$  are constants). We find the expressions for Riemann curvature and Ricci curvature of the special  $(\alpha, \beta)$ -metric, when  $\beta$  the 1- form is a killing form of constant length. We give a characterization of the projective flatness for the special  $(\alpha, \beta)$ - metric.

**Key Words:** Finsler space with  $(\alpha, \beta)$ -metric, Ricci curvature, Riemann curvature, projectively flat.

**AMS(2010):** 53B40, 53C60

### §1. Introduction

A Finsler metric  $F(x, y)$  on an  $n$ -dimensional manifold  $M^n$  is called an  $(\alpha, \beta)$ -metric ([4])  $F(x, y)$ , if  $F$  is positively homogeneous function of  $\alpha$  and  $\beta$  of degree one, where  $\alpha^2 = a_{ij}(x)y^i y^j$  is a Riemannian metric and  $\beta = b_i(x)y^i$  is a 1-form on  $M^n$ . The  $(\alpha, \beta)$ -metrics form an important class of Finsler metrics appearing iteratively in formulating physics, mechanics, Seismology, Biology, control theory, etc ([1], [6]). There are several interesting curvatures in Finsler geometry ([2], [5]), among them two important curvatures are Riemann curvature and Ricci curvature.

Riemannian metrics on a manifold are quadratic metrics, while Finsler metrics are those without restriction on the quadratic property. The Riemannian curvature in Riemannian geometry can be extended to Finsler metrics as a family of linear transformations on the tangent spaces. The Ricci curvature plays an important role in the geometry of Finsler manifolds and is defined as the trace of the Riemannian curvature on each tangent space.

Consider the Finsler space  $F^n = (M^n, F)$  that is equipped with the special  $(\alpha, \beta)$ -metric  $F = \alpha + \epsilon\beta + k\frac{\beta^2}{\alpha}$  ( $\epsilon \neq 0, k \neq 0$  are constants), where  $\alpha^2 = a_{ij}(x)y^i y^j$  is a Riemannian metric

---

<sup>1</sup>Received April 27, 2016, Accepted November 10, 2016.

and  $\beta = b_i(x)y^i$  is a 1-form on an  $n$ -dimensional manifold  $M^n$ . Then the space  $R^n = (M^n, \alpha)$  is called the associated Riemannian space with  $F^n = (M^n, F)$ . The covariant differentiation with respect to the Levi Civita connection  $\gamma_{jk}^i(x)$  of  $R^n$  is denoted by  $(\cdot)$ . We put  $a^{ij} = (a_{ij})^{-1}$

The main purpose of the current paper is to investigate the curvature properties of the special  $(\alpha, \beta)$ -metric  $\alpha + \epsilon\beta + k\frac{\beta^2}{\alpha}$  ( $\epsilon, k \neq 0$ ). The paper is organized as follows: Starting with literature survey in section one, we find the Riemann curvature and Ricci curvature of the Finsler space with special  $(\alpha, \beta)$ - metric  $\alpha + \epsilon\beta + k\frac{\beta^2}{\alpha}$  in section two (see Theorem 2.1). In section three, we obtain the necessary and sufficient conditions for a Finsler space with  $(\alpha, \beta)$ -metric to be locally projectively flat (see Theorem 3.1 ).

## §2. Riemann curvature and Ricci curvature of special $(\alpha, \beta)$ -metric $\alpha + \epsilon\beta + k\frac{\beta^2}{\alpha}$

Let  $F$  be a Finsler metric on an  $n$ -dimensional manifold  $M$  and  $G^i$  be the geodesic coefficient of  $F$ , which is defined by

$$G^i = \frac{1}{4}g^{il}\{[F^2]_{x^m y^l} y^m - [F^2]_{x^l}\}. \quad (1)$$

For any  $x \in M$  and  $y \in T_x M \setminus \{0\}$ , the Riemann curvature  $\mathbf{R}_y = R_m^i \frac{\partial}{\partial x^i} \otimes dx^m : T_x M^n \rightarrow T_x M^n$  is defined by

$$R_m^i = 2\frac{\partial G^i}{\partial x^m} - \frac{\partial^2 G^i}{\partial x^m \partial y^m} y^m + 2G^m \frac{\partial^2 G^i}{\partial y^m \partial y^m} - \frac{\partial G^i}{\partial y^m} \frac{\partial G^m}{\partial y^m}. \quad (2)$$

The Ricci curvature is the trace of the Riemann curvature, and the Ricci scalar is defined by

$$Ric = R_i^i, \quad R = \frac{1}{n-1} Ric. \quad (3)$$

By definition, an  $(\alpha, \beta)$ -metric on  $M$  is expressed in the form  $F = \alpha\phi(s)$ ,  $s = \frac{\beta}{\alpha}$ , where  $\alpha = \sqrt{a_{ij}(x)y^i y^j}$  is a positive definite Riemannian metric,  $\beta = b_i(x)y^i$  is a 1-form. It is known that  $(\alpha, \beta)$ -metric with  $\|\beta_x\|_\alpha < b_0$  is a Finsler metric if and only if  $\phi = \phi(s)$  is a positive smooth function on an open interval  $(-b_0, b_0)$  satisfying the following conditions:

$$\phi(s) - s\phi' + (b^2 - s^2)\phi''(s) > 0, \quad \forall |s| \leq b < b_0. \quad (4)$$

For a special  $(\alpha, \beta)$ -metric  $\alpha + \epsilon\beta + k\frac{\beta^2}{\alpha}$ , we have

$$\phi(s) = (1 + \epsilon s + ks^2); \quad s = \frac{\beta}{\alpha}. \quad (5)$$

Let  $G^i(x, y)$  and  $G_\alpha^i(x, y)$  denote the spray coefficients of  $F$  and  $\alpha$  respectively. To express formula for the spray coefficients  $G^i$  of  $F$  in terms of  $\alpha$  and  $\beta$ , we need to introduce some

notations. Let  $b_{i;j}$  be a covariant derivative of  $b_i$  with respect to  $y^j$ . Denote

$$\begin{aligned} r_{ij} &= \frac{1}{2}(b_{i|j} + b_{j|i}), & s_{ij} &= \frac{1}{2}(b_{i|j} - b_{j|i}), \\ s_j^i &= a^{ih} s_{hj}, & s_j &= b_i s_j^i = s_{ij} b^i, & r_j &= r_{ij} b^i, \\ r_0 &= r_j y^j, & s_0 &= s_j y^j, & r_{00} &= r_{ij} y^i y^j. \end{aligned}$$

**Lemma 2.1**([3]) For an  $(\alpha, \beta)$ -metric  $F = \alpha\phi(s)$ ,  $s = \frac{\beta}{\alpha}$ , the geodesic coefficients  $G^i$  are given by

$$G^i = G_\alpha^i + \alpha Q s_0^i + \Theta(-2\alpha Q s_0 + r_{00}) \frac{y^i}{\alpha} + \psi(-2\alpha Q s_0 + r_{00}) \left(b^i - \frac{y^i}{\alpha}\right), \quad (6)$$

where

$$\begin{aligned} Q &= \frac{\phi}{\phi - s\phi'}, \\ \Theta &= \frac{(\phi - s\phi')\phi'}{2\phi((\phi - s\phi') + (b^2 - s^2))\phi''}, \\ \Psi &= \frac{\phi''}{2((\phi - s\phi') + (b^2 - s^2))\phi''}. \end{aligned}$$

Here  $b^i = a^{ij} b_j$ , and  $b^2 = a^{ij} b_i b_j = b_j b^j$ .

**Lemma 2.2** For a special  $(\alpha, \beta)$ -metric  $F = \alpha + \epsilon\beta + k\frac{\beta^2}{\alpha}$ , the geodesic coefficients  $G^i$  are given by

$$\begin{aligned} G^i &= G_\alpha^i + \alpha \frac{(\epsilon + 2ks)}{1 - ks^2} s_0^i \\ &+ \frac{(\epsilon + 2ks - \epsilon ks^2 - 2k^2 s^3)}{2(1 + 2kb^2 - 3ks^2)(1 + \epsilon s + ks^2)} \left[ -2\alpha \frac{(\epsilon + 2ks)}{1 - ks^2} s_0 \right. \\ &\left. + r_{00} \right] \frac{y^i}{\alpha} + \frac{k}{1 + 2kb^2 - 3ks^2} \left[ -2\alpha \frac{(\epsilon + 2ks)}{1 - ks^2} s_0 + r_{00} \right] \left(b^i - \frac{y^i}{\alpha}\right) \end{aligned} \quad (7)$$

*Proof* By a direct computation, we get (7) from (6) □

**Theorem 2.1** For a Finsler space with special  $(\alpha, \beta)$ - metric  $F = \alpha + \epsilon\beta + k\frac{\beta^2}{\alpha}$ , the Ricci curvature of  $F$  is given by

$$Ric = \overline{Ric} + T, \quad (8)$$

where  $\overline{Ric}(= {}^\alpha Ric)$  denotes the Ricci curvature of  $\alpha$ , and

$$\begin{aligned} T &= \frac{4kF\alpha^3}{(\alpha^2 - k\beta^2)^2} s_{0j} s_0^m + 2 \frac{\alpha^2(\epsilon\alpha + 2k\beta)}{\alpha^2 - k\beta^2} s_{0;j}^m \\ &+ \frac{2(\epsilon\alpha^2 + 2k\alpha\beta)\{\epsilon\alpha^4 - \epsilon k\alpha^2\beta^2 + 2k\alpha^3\beta - 2k^2\alpha\beta^3 + 2sk\alpha^3 F\}}{(\alpha^2 - k\beta^2)^3} s_{0m} s_0^m \\ &- \alpha^2 \frac{(\epsilon\alpha^2 + 2k\alpha\beta)^2}{(\alpha^2 - k\beta^2)^2} s_j^m s_m^j \end{aligned}$$

*Proof* Consider the Finsler space with special  $(\alpha, \beta)$ - metric  $F = \alpha + \epsilon\beta + k\frac{\beta^2}{\alpha}$  on an  $n$ -dimensional manifold  $M^n$ . From Lemma 2.2, the geodesic coefficients  $G^i$  of  $F$  are related to the coefficients  $G_\alpha^i$  of  $\alpha$  by

$$G^i = G_\alpha^i + Py^i + T^i, \quad (9)$$

where

$$\begin{aligned} P &= \frac{[\epsilon - 2k + 2k(1 - \epsilon)s - (\epsilon + 2k)ks^2 - 2k^2s^3]}{2\alpha(1 + 2kb^2 - 3ks^2)(1 + \epsilon s + ks^2)} \left[ -2\alpha \frac{(\epsilon + 2ks)}{1 - ks^2} s_0 + r_{00} \right], \\ T^i &= \frac{\alpha(\epsilon + 2ks)}{1 - ks^2} s_0^i + \frac{k}{1 + 2kb^2 - 3\delta s^2} \left[ \frac{-2\alpha(\epsilon + 2ks)s_0}{1 - ks^2} + r_{00} \right] b^i. \end{aligned} \quad (10)$$

In this section, we assume that  $\beta$  is a killing form of constant length i. e.,  $\beta$  satisfies

$$r_{ij} = 0, \quad \text{and} \quad b^j b_{j:m} = 0. \quad (11)$$

Equation (11) implies that

$$s_{ij} = b_{i;j}, \quad s_j = b^i s_{ij} = 0, \quad b^i s_i^j = b^i s_{ri} a^{jr} = -b^i s_{ir} a^{jr} = 0. \quad (12)$$

Thus  $P = 0$  and (9) reduces to

$$G^i = G_\alpha^i + T^i, \quad (13)$$

where

$$T^i = \frac{\alpha(\epsilon + 2ks)}{1 - ks^2} s_0^i, \quad (14)$$

Now from (2) and (13), we obtain ([7])

$$R_m^i = \alpha R_m^i + 2T_{:m}^i - y^j T_{:j;m}^i - T_{:j}^i T_{:m}^j + 2T^j T_{:j;m}^i, \quad (15)$$

where  $T_{:j}^i = \frac{\partial T^i}{\partial y^j}$ . Thus the Ricci curvature of  $F$  is related to the Ricci curvature of  $\alpha$  by

$$Ric = \overline{Ric} + 2T_{:m}^m - y^j T_{:j;m}^m - T_{:j}^m T_{:m}^j + 2T^j T_{:j;m}^m, \quad (16)$$

where “:” and “.” denotes the horizontal covariant derivative and vertical covariant derivative with respect to the Berwald connection determined by  $\tilde{G}^i$  respectively.

Note that

$$\alpha_{:m} = 0, \quad y_{:m} = 0, \quad \beta_{:m} = r_{0m} + s_{0m}, \quad b_{:m}^2 = 2(r_m + s_m), \quad b_{:m}^i = r_m^i + s_m^i.$$

$$s_{:i} = \frac{b_i}{\alpha} - \frac{sy_i}{\alpha^2}, \quad s_{:i} = \frac{s_{0i}}{\alpha}, \quad s_{:j,i} = \frac{(b_j y_i + b_i y_j)}{\alpha^3} + 3s \frac{y_i y_j}{\alpha^4} - s \frac{a_{ji}}{\alpha^2}$$

We have  $F_{:m} = (\alpha + \epsilon\beta + k\frac{\beta^2}{\alpha})_{:m} = \left( \epsilon + \frac{2k\beta}{\alpha} \right) b_{0:m}$  and  $F_{y^m} = (\alpha + \epsilon\beta + k\frac{\beta^2}{\alpha})_{y^m} = \frac{y_m}{\alpha} +$

$\epsilon b_m + k \frac{\beta^2 y_m}{\alpha^3}$ . Thus from (14), we have

$$\begin{aligned} T_{:j}^m &= \frac{2kF s_{0j} s_0^m}{(1 - ks^2)^2 \alpha} + \frac{\alpha(\epsilon + 2ks)}{1 - ks^2} s_{0:j}^m \\ &= \frac{2kF \alpha^3}{(\alpha^2 - k\beta^2)^2} s_{0j} s_0^m + \frac{\alpha^2(\epsilon\alpha + 2k\beta)}{\alpha^2 - k\beta^2} s_{0:j}^m. \end{aligned} \quad (17)$$

Using  $b_i s_0^i = 0$ ,  $b_i s_j^i = 0$ ,  $y_i s_0^i = 0$  &  $y_i s_{0:j}^i = 0$ , we obtain  $T_{j:m}^m = 0$  and  $T_{j:m}^m y^j = 0$ . Consequently, we obtain the following

$$\begin{aligned} T^j T_{:j.k}^k &= \frac{(\epsilon\alpha^2 + 2k\alpha\beta)^2}{(\alpha^2 - k\beta^2)^2} s_{k0} s_0^k - s \frac{2kF \alpha^3}{(\alpha^2 - k\beta^2)^2} s_{j0} s_0^j \\ &\quad + \frac{(\epsilon\alpha^2 + 2k\alpha\beta)^2}{(\alpha^2 - k\beta^2)^2} s_0^j s_j^0 - s \frac{2k\alpha^3 F(\epsilon\alpha^2 + 2k\alpha\beta)}{(\alpha^2 - k\beta^2)^3} s_0^j s_j^0. \end{aligned}$$

$$T_{:j}^m T_{:m}^j = 2 \frac{(\epsilon\alpha^2 + 2k\alpha\beta)^2}{(\alpha^2 - k\beta^2)^2} s_{0m} s_0^m - 2s \frac{2k\alpha^3 F(\epsilon\alpha^2 + 2k\alpha\beta)}{(\alpha^2 - k\beta^2)^3} s_{0m} s_0^m + \alpha^2 \frac{(\epsilon\alpha^2 + 2k\alpha\beta)^2}{(\alpha^2 - k\beta^2)^2} s_j^m s_m^j.$$

Plugging these values into (16), we get

$$\begin{aligned} Ric &= \overline{Ric} + 2T_{:m}^m - y^j T_{:j.m}^m - T_{:j}^m T_{:m}^j + 2T^j T_{:j.m}^m \\ &= \overline{Ric} + \frac{4kF \alpha^3}{(\alpha^2 - k\beta^2)^2} s_{0j} s_0^m + 2 \frac{\alpha^2(\epsilon\alpha + 2k\beta)}{\alpha^2 - k\beta^2} s_{0:j}^m + 2 \frac{(\epsilon\alpha^2 + 2k\alpha\beta)^2}{(\alpha^2 - k\beta^2)^2} s_{0m} s_0^m + \\ &\quad \frac{4sk\alpha^3 F(\epsilon\alpha^2 + 2k\alpha\beta)}{(\alpha^2 - k\beta^2)^3} s_{0m} s_0^m - \alpha^2 \frac{(\epsilon\alpha^2 + 2k\alpha\beta)^2}{(\alpha^2 - k\beta^2)^2} s_j^m s_m^j + 2 \frac{(\epsilon\alpha^2 + 2k\alpha\beta)^2}{(\alpha^2 - k\beta^2)^2} s_{m0} s_0^m \\ &\quad - 2s \frac{2kF \alpha^3}{(\alpha^2 - k\beta^2)^2} s_{j0} s_0^j + 2 \frac{(\epsilon\alpha^2 + 2k\alpha\beta)^2}{(\alpha^2 - k\beta^2)^2} s_0^j s_j^0 - 4s \frac{k\alpha^3 F(\epsilon\alpha^2 + 2k\alpha\beta)}{(\alpha^2 - k\beta^2)^3} s_0^j s_j^0. \end{aligned} \quad (18)$$

Since  $s_{m0} = -s_{0m}$  and  $s_j^0 = -s_{j0}$ , equation (18) becomes

$$\begin{aligned} Ric &= \overline{Ric} + \frac{4kF \alpha^3}{(\alpha^2 - k\beta^2)^2} s_{0j} s_0^m + 2 \frac{\alpha^2(\epsilon\alpha + 2k\beta)}{\alpha^2 - k\beta^2} s_{0:j}^m + 2 \frac{(\epsilon\alpha^2 + 2k\alpha\beta)^2}{(\alpha^2 - k\beta^2)^2} s_{0m} s_0^m + \\ &\quad \frac{4sk\alpha^3 F(\epsilon\alpha^2 + 2k\alpha\beta)}{(\alpha^2 - k\beta^2)^3} s_{0m} s_0^m - \alpha^2 \frac{(\epsilon\alpha^2 + 2k\alpha\beta)^2}{(\alpha^2 - k\beta^2)^2} s_j^m s_m^j \\ &= \overline{Ric} + \frac{4kF \alpha^3}{(\alpha^2 - k\beta^2)^2} s_{0j} s_0^m + 2 \frac{\alpha^2(\epsilon\alpha + 2k\beta)}{\alpha^2 - k\beta^2} s_{0:j}^m + \\ &\quad \frac{2(\epsilon\alpha^2 + 2k\alpha\beta)\{\epsilon\alpha^4 - \epsilon k\alpha^2 \beta^2 + 2k\alpha^3 \beta - 2k^2 \alpha \beta^3 + 2sk\alpha^3 F\}}{(\alpha^2 - k\beta^2)^3} s_{0m} s_0^m - \\ &\quad \alpha^2 \frac{(\epsilon\alpha^2 + 2k\alpha\beta)^2}{(\alpha^2 - k\beta^2)^2} s_j^m s_m^j. \end{aligned} \quad (19)$$

This completes the proof.  $\square$

### §3. Projectively Flat $(\alpha, \beta)$ -metric

A Finsler metric  $F = F(x, y)$  on an open subset  $U \subset R^n$  is projectively flat [3] if and only if

$$F_{x^m y^l} y^m - F_{x^l} = 0. \quad (20)$$

By (20), we have the following lemma ([8]).

**Lemma 3.1** *An  $(\alpha, \beta)$ - metric  $F = \alpha\phi(s)$ , where  $s = \frac{\beta}{\alpha}$ , is projectively flat on an open subset  $U \subset R^n$  if and only if*

$$(a_{ml}\alpha^2 - y_m y_l) G_\alpha^m + \alpha^3 Q s_{l0} + \psi\alpha(-2\alpha Q s_0 + r_{00})(b_l\alpha - s y_l) = 0. \quad (21)$$

In this section, we consider the Finsler space with special  $(\alpha, \beta)$ - metric  $F = \alpha + \epsilon\beta + k\frac{\beta^2}{\alpha}$ , where  $\epsilon, k \neq 0$  are constants. We have

$$F = \alpha\phi(s), \quad \phi(s) = (1 + \epsilon s + k s^2). \quad (22)$$

Let  $b_0 > 0$  be the largest number such that

$$\phi(s) - s\phi'(s) + (b^2 - s^2)\phi''(s) > 0, \quad (|s| \leq b < b_0). \quad (23)$$

That is,

$$1 + 2kb^2 - 4ks^2 > 0, \quad (|s| \leq b < b_0). \quad (24)$$

**Lemma 3.2**  *$F = \alpha + \epsilon\beta + k\frac{\beta^2}{\alpha}$  is a Finsler metric iff  $\|\beta\|_\alpha < 1$ .*

*Proof* If  $F = \alpha + \epsilon\beta + k\frac{\beta^2}{\alpha}$  is a Finsler metric, then

$$1 + 2kb^2 - 4ks^2 > 0, \quad (|s| \leq b < b_0). \quad (25)$$

Let  $s = b$ , then we get  $b < \frac{1}{\sqrt{2k}}, \forall b < b_0$ . Let  $b \rightarrow b_0$ , then  $b_0 < \frac{1}{\sqrt{2k}}$ . So  $\|\beta\|_\alpha < 1$ . Now, if

$$|s| \leq b < \frac{1}{\sqrt{2k}} \quad (26)$$

then

$$1 + 2kb^2 - 4ks^2 > 0, \quad (|s| \leq b < b_0). \quad (27)$$

Thus  $F = \alpha + \epsilon\beta + k\frac{\beta^2}{\alpha}$  is a Finsler metric.  $\square$

By Lemma 2.2, the spray coefficients are given by

$$\begin{aligned} Q &= \frac{\epsilon\alpha^2 + 2k\alpha\beta}{\alpha^2 - k\beta^2}, \\ \Theta &= \frac{\epsilon\alpha^3 - 2k\alpha^2\beta - \epsilon k\alpha\beta^2 - 2k^2\beta^3}{2\{(1 + 2kb^2)\alpha^2 - 3k\beta^2\}\{\alpha^2 + \epsilon\alpha\beta + k\beta^2\}}, \\ \psi &= \frac{k\alpha^2}{(1 + 2kb^2)\alpha^2 - 3k\beta^2}. \end{aligned}$$

Equation (21) is reduced to the following form:

$$\begin{aligned} (a_{ml}\alpha^2 - y_m y_l)G_\alpha^m + \alpha^3 \left( \frac{\epsilon\alpha^2 + 2k\alpha\beta}{\alpha^2 - k\beta^2} \right) s_{l0} + \alpha \left( \frac{k\alpha^2}{(1 + 2kb^2)\alpha^2 - 3k\beta^2} \right) \\ \left[ -2\alpha \left( \frac{\epsilon\alpha^2 + 2k\alpha\beta}{\alpha^2 - k\beta^2} \right) s_0 + r_{00} \right] \left( b_l \alpha - \frac{\beta}{\alpha} y_l \right) = 0. \end{aligned} \quad (28)$$

**Lemma 3.3** *If  $(a_{ml}\alpha^2 - y_m y_l)G_\alpha^m = 0$ , then  $\alpha$  is projectively flat.*

*Proof* If  $(a_{ml}\alpha^2 - y_m y_l)G_\alpha^m = 0$ , then

$$a_{ml}\alpha^2 = y_m y_l G_\alpha^m,$$

then there is a  $\eta = \eta(x, y)$  such that  $y_m G_\alpha^m = \alpha^2 \eta$ , we get

$$a_{ml}G_\alpha^m = \eta y_l.$$

Contracting with  $a^{il}$  yields  $G_\alpha^i = \eta y^i$ , and thus  $\alpha$  is projectively flat.  $\square$

**Theorem 3.1** *A Finsler space with special  $(\alpha, \beta)$ -metric  $F = \alpha + \epsilon\beta + k\frac{\beta^2}{\alpha}$  (where  $\epsilon, k \neq 0$  are constants) is locally projectively flat iff*

- (1)  $\beta$  is parallel with respect to  $\alpha$ ;
- (2)  $\alpha$  is locally projectively flat, i. e., of constant curvature.

*Proof* Suppose that F is locally projectively flat. First, we rewrite (28) as a polynomial in  $y^i$  and  $\alpha$ . This gives,

$$\begin{aligned} (a_{ml}\alpha^2 - y_m y_l)G_\alpha^m \left[ \{(1 + 2kb^2)\alpha^2 - 3k\beta^2\}\{\alpha^2 - k\beta^2\} \right] + 2k\alpha^4\beta\{(1 + \\ 2kb^2)\alpha^2 - 3k\beta^2\}s_{l0} + kr_{00}\alpha^2(\alpha^2 - k\beta^2)(b_l\alpha^2 - \beta y_l) - 4k^2\alpha^4\beta s_0(b_l\alpha^2 - \\ \beta y_l) + \alpha \left\{ \epsilon\alpha^4 \{ (1 + 2kb^2)\alpha^2 - 3k\beta^2 \} s_{l0} - 2\epsilon k\alpha^4 s_0 (b_l\alpha^2 - \beta y_l) \right\} = 0. \end{aligned} \quad (29)$$

or

$$U + \alpha V = 0, \quad (30)$$



where

$$\begin{aligned} U = & (a_{ml}\alpha^2 - y_m y_l)G_\alpha^m \left[ \{(1 + 2kb^2)\alpha^2 - 3k\beta^2\}\{\alpha^2 - k\beta^2\} \right] + 2k\alpha^4\beta\{(1 + \\ & 2kb^2)\alpha^2 - 3k\beta^2\}s_{l0} + kr_{00}\alpha^2(\alpha^2 - k\beta^2)(b_l\alpha^2 - \beta y_l) - 4k^2\alpha^4\beta s_0 \\ & (b_l\alpha^2 - \beta y_l), \end{aligned}$$

and

$$V = \epsilon\alpha^4\{(1 + 2kb^2)\alpha^2 - 3k\beta^2\}s_{l0} - 2\epsilon k\alpha^4 s_0(b_l\alpha^2 - \beta y_l).$$

Now, (30) is a polynomial in  $(y^i)$ , such that  $U$  and  $V$  are rational in  $y^i$  and  $\alpha$  is irrational. Therefore, we must have

$$U = 0 \text{ and } V = 0, \quad (31)$$

which implies that

$$\begin{aligned} & (a_{ml}\alpha^2 - y_m y_l)G_\alpha^m \left[ \{(1 + 2kb^2)\alpha^2 - 3k\beta^2\}\{\alpha^2 - k\beta^2\} \right] + 2k\alpha^4\beta\{(1 + \\ & + 2kb^2)\alpha^2 - 3k\beta^2\}s_{l0} + kr_{00}\alpha^2(\alpha^2 - k\beta^2)(b_l\alpha^2 - \beta y_l) - 4k^2\alpha^4\beta s_0 \\ & (b_l\alpha^2 - \beta y_l) = 0 \quad (32) \end{aligned}$$

and

$$\epsilon\alpha^4\{(1 + 2kb^2)\alpha^2 - 3k\beta^2\}s_{l0} - 2\epsilon k\alpha^4 s_0(b_l\alpha^2 - \beta y_l) = 0. \quad (33)$$

From (30), considering only terms which do not contain  $\beta$ . There exists a homogenous polynomial  $V_7$  of degree seven in  $y^i$  such that

$$\left\{ (1 + 2kb^2)\epsilon s_{l0} - 2k\epsilon b_l s_0 \right\} \alpha^7 = \beta V_7. \quad (34)$$

Since  $\alpha^2 \not\equiv o(\text{mod}\beta)$ , we must have a function  $u^l = u^l(x)$  satisfying

$$(1 + 2kb^2)\epsilon s_{l0} - 2k\epsilon b_l s_0 = u^l \beta. \quad (35)$$

Transvecting (35) by  $b_l$ , we have

$$(1 + 2kb^2)\epsilon s_0 - 2k\epsilon b^2 s_0 = u^l \beta b^l. \quad (36)$$

That is,

$$\epsilon s_j = u^l b_l b_j. \quad (37)$$

Further transvecting by  $b^j$ , we have  $u^i b_i b^2 = 0$ , which implies  $u^l b_l = 0$ . Substituting this equation into (36), we get  $s_0 = 0$ . Now, from (32), by contracting with  $b^l$ , we get

$$\begin{aligned} & (b_m\alpha^2 - y_m\beta)G_\alpha^m \left[ \{(1 + 2kb^2)\alpha^2 - 3k\beta^2\}\{\alpha^2 - k\beta^2\} \right] + 2k\alpha^4\beta\{(1 + \\ & 2kb^2)\alpha^2 - 3k\beta^2\}s_0 + kr_{00}\alpha^2(\alpha^2 - k\beta^2)(b^2\alpha^2 - \beta^2) - 4k^2\alpha^4\beta s_0(b_l\alpha^2 - \beta y_l) = 0. \quad (38) \end{aligned}$$

Since  $s_0 = 0$ , we get

$$(b_m \alpha^2 - y_m \beta) G_\alpha^m \left[ \{(1 + 2kb^2)\alpha^2 - 3k\beta^2\} \{\alpha^2 - k\beta^2\} \right] + kr_{00} \alpha^2 (\alpha^2 - k\beta^2) (b^2 \alpha^2 - \beta^2) = 0. \quad (39)$$

Contracting (39) by  $y^m$ , we get

$$r_{00} = 0. \quad (40)$$

From (33), we get

$$s_{l0} = 0. \quad (41)$$

Then by (40) and Lemma 3.3,  $\alpha$  is projectively flat. From (40) and (41),  $b_{i;j} = 0$ , i. e.,  $\beta$  is parallel to  $\alpha$ .

Conversely, if  $\beta$  is parallel with respect to  $\alpha$  and  $\alpha$  is locally projectively flat, then by Lemma 3.3, we can easily see that F is locally projectively flat.  $\square$

## References

- [1] P. L. Antonelli, A. Bona, M. A. Slawinski, Seismic rays as Finsler geodesics, *Nonlinear Anal*, RWA, 4 (2003), 711-722.
- [2] S. Bacso, X. Cheng and Z. Shen, Curvature properties of  $(\alpha, \beta)$ -metric, *Advanced Studies in Pure Mathematics, Math. Soc. of Japan*, 48 (2007), 73-110.
- [3] S. S. Chern and Z. Shen, *Riemann- Finsler Geometry*, World Scientific, Singapore, 2005.
- [4] M. Matsumoto, *Foundation of Finsler geometry and special Finsler spaces*, Kaiseisha Press, Otsu (1986).
- [5] H. G. Nagaraja, On Kropina metrics, *Afrika Matematika*, 25(3) (2013), 519-527.
- [6] M. Rafie- Rad, Time-optimal solution of parallel navigation and Finsler geodesic, *Nonlinear Anal*, RWA, 11 (2010), 3809-3814.
- [7] Z. Shen, *Lectures on Finsler Geometry*, World scientific, Singapore (2001).
- [8] Z. Shen and G. C. Yildirim, On a class of projectively flat metrics with constant flag curvature, *Canadian Journal of Mathematics*, 60 (2), (2008), 443-456.

## Nonsplit Roman Domination in Graphs

C.Sivagnanam

(Department of General Requirements, College of Applied Sciences - Sur, Sultanate of Oman)

E-mail: choshi71@gmail.com

**Abstract:** A roman dominating function on a graph  $G$  is a function  $f : V(G) \rightarrow \{0, 1, 2\}$  satisfying the condition that every vertex  $v \in V(G)$  for which  $f(v) = 0$ , is adjacent to at least one vertex  $u$  with  $f(u) = 2$ . The weight of a roman dominating function  $f$  is the value  $w(f) = \sum_{v \in V} f(v)$ . The minimum weight of a roman dominating function is called the roman domination number of  $G$  and is denoted by  $\gamma_R(G)$ . A roman dominating function  $f$  is called a nonsplit roman dominating function if the subgraph induced by the set  $\{v : f(v) = 0\}$  is connected. The minimum weight of a nonsplit roman dominating function is called the nonsplit roman domination number and is denoted by  $\gamma_{nsr}(G)$ . In this paper, we initiate a study of this parameter.

**Key Words:** Domination number, roman domination number and nonsplit roman domination number.

**AMS(2010):** 05C69.

### §1. Introduction

The graph  $G = (V, E)$  we mean a finite, undirected, connected graph with neither loops nor multiple edges. The order and size of  $G$  are denoted by  $n$  and  $m$  respectively. The degree of a vertex  $u$  in  $G$  is the number of edges incident with  $u$  and is denoted by  $d_G(u)$ , simply  $d(u)$ . The minimum and maximum degree of a graph  $G$  is denoted by  $\delta(G)$  and  $\Delta(G)$ , respectively. For graph theoretic terminology we refer to Chartrand and Lesniak [1] and Haynes et.al [3, 4].

Let  $v \in V$ . The open neighborhood and closed neighborhood of  $v$  are denoted by  $N(v)$  and  $N[v] = N(v) \cup \{v\}$ . If  $S \subseteq V$  then  $N(S) = \bigcup_{v \in S} N(v)$  for all  $v \in S$  and  $N[S] = N(S) \cup S$ . If  $S \subseteq V$  and  $u \in S$  then the private neighbor set of  $u$  with respect to  $S$  is defined by  $pn[u, S] = \{v : N[v] \cap S = \{u\}\}$ . For any set  $S \subseteq V$ , the subgraph induced by  $S$  is the maximal subgraph of  $G$  with vertex set  $S$  and is denoted by  $\langle S \rangle$ . The vertex has degree one is called a pendant vertex. A support is a vertex which is adjacent to a pendant vertex. A weak support is a vertex which is adjacent to exactly one pendant vertex. A strong support is a vertex which is adjacent to at least two pendant vertices. An unicyclic graph is a graph with exactly one cycle. A graph without cycle is called acyclic graph and a connected acyclic graph is called a tree.  $H(m_1, m_2, \dots, m_n)$  denotes the graph obtained from the graph  $H$  by attaching  $m_i$

---

<sup>1</sup>Received January 31, 2016, Accepted August 23, 2016.

pendant edges to the vertex  $v_i \in V(H)$ ,  $1 \leq i \leq n$ . The graph  $K_2(m_1, m_2)$  is called bistar and it is also denoted by  $B(m_1, m_2)$ .  $H(P_{m_1}, P_{m_2}, \dots, P_{m_n})$  is the graph obtained from the graph  $H$  by attaching an end vertex of  $P_{m_i}$  to the vertex  $v_i$  in  $H$ ,  $1 \leq i \leq n$ . The clique number  $\omega(G)$  is the maximum order of the complete subgraph of the graph  $G$ .

A subset  $S$  of  $V$  is called a dominating set of  $G$  if every vertex in  $V - S$  is adjacent to at least one vertex in  $S$ . The minimum cardinality of a dominating set is called the domination number of  $G$  and is denoted by  $\gamma(G)$ . V.R.Kulli and B.Janakiram [5] introduced the concept of nonsplit domination in graphs. Also T.Tamizh Chelvam and B.Jayaparsad [6] studied the same concept in the name of the complementary connected domination in graphs. A dominating set  $S$  is called a nonsplit dominating set of a graph  $G$  if the induced subgraph  $\langle V - S \rangle$  is connected. The minimum cardinality of a nonsplit dominating set of  $G$  is called the nonsplit domination number of  $G$  and is denoted by  $\gamma_{ns}(G)$ . A dominating set (nonsplit dominating set) of minimum cardinality is called  $\gamma$ -set ( $\gamma_{ns}$ -set) of  $G$ . E.J.Cockayne et.al [2] studied the concept of roman domination first. A roman dominating function on a graph  $G$  is a function  $f : V(G) \rightarrow \{0, 1, 2\}$  satisfying the condition that every vertex  $v \in V$  for which  $f(v) = 0$  is adjacent to at least one vertex  $u \in V$  with  $f(u) = 2$ . The weight of a roman dominating function is the value  $w(f) = \sum_{v \in V} f(v)$ . The minimum weight of a roman dominating function is called the roman dominating number of  $G$  and is denoted by  $\gamma_R(G)$ . P.Roushini Leely Pushpam and S.Padmapriya [6] introduced the concept of restrained roman domination in graphs. A roman dominating function  $f$  is called a restrained roman dominating function if the subgraph induced by the set  $\{v : f(v) = 0\}$  contains no isolated vertex. The minimum weight of a restrained roman dominating function is called the restrained roman domination number of  $G$  and is denoted by  $\gamma_{rR}(G)$ . In this paper we introduce the concept of nonsplit roman domination and initiate a study of the corresponding parameter.

**Theorem 1.1** ([7]) *Let  $G$  be a graph. Then  $\gamma_{ns}(G) = n - 1$  if and only if  $G$  is a star.*

## §2. Nonsplit Roman Domination Number

**Definition 2.1** *A roman dominating function  $f$  is called a nonsplit roman dominating function if the subgraph induced by the set  $\{v : f(v) = 0\}$  is connected. The minimum weight of a nonsplit roman dominating function is called the nonsplit roman domination number of  $G$  and is denoted by  $\gamma_{nsr}(G)$ .*

**Remark 2.2** For a graph  $G$ , let  $f : V \rightarrow \{0, 1, 2\}$  and let  $(V_0, V_1, V_2)$  be the ordered partition of  $V$  induced by  $f$ , where  $V_i = \{v \in V : f(v) = i\}$ . Note that there exists an one to one correspondence between the function  $f : V \rightarrow \{0, 1, 2\}$  and the ordered partition  $(V_0, V_1, V_2)$  of  $V$ . Thus we will write  $f = (V_0, V_1, V_2)$ .

A function  $f = (V_0, V_1, V_2)$  is a nonsplit roman dominating function if  $V_0 \subseteq N(V_2)$  and the induced subgraph  $\langle V_0 \rangle$  is connected. The minimum weight of a nonsplit roman dominating function of  $G$  is called the nonsplit roman domination number of  $G$  and is denoted by  $\gamma_{nsr}(G)$ . We say that a function  $f = (V_0, V_1, V_2)$  is a  $\gamma_{nsr}$ -function if it is a nonsplit roman dominating

function and  $w(f) = \gamma_{nsr}(G)$ . Also  $w(f) = |V_1| + 2|V_2|$ .

A few nonsplit roman domination number of some standard graphs are listed in the following.

- (1) Any nontrivial path  $P_n$ ,  $\gamma_{nsr}(P_n) = n$ ;
- (2) If  $n \geq 4$  then  $\gamma_{nsr}(C_n) = n$ ;
- (3) If  $n \geq 2$  then  $\gamma_{nsr}(K_n) = 2$ ;
- (4)  $\gamma_{nsr}(W_n) = 2$ ;
- (5)  $\gamma_{nsr}(K_{1,n-1}) = n$ ;
- (6)  $\gamma_{nsr}(K_{r,s}) = 4$  where  $r, s \geq 2$ .

**Theorem 2.3** For a graph  $G$ ,  $\gamma_{ns}(G) \leq \gamma_{nsr}(G) \leq 2\gamma_{ns}(G)$ .

*Proof* Let  $f = (V_0, V_1, V_2)$  be a  $\gamma_{nsr}$ -function. Then  $V_1 \cup V_2$  is a nonsplit dominating set of  $G$ . Hence  $\gamma_{ns} \leq |V_1 \cup V_2| = |V_1| + |V_2| \leq |V_1| + 2|V_2| = \gamma_{nsr}$ . Also, let  $S$  be any  $\gamma_{ns}$ -set of  $G$ . Then  $f = (V - S, \phi, S)$  is a nonsplit roman dominating function of  $G$ . Hence  $\gamma_{nsr}(G) \leq 2|S| = 2\gamma_{ns}(G)$ .  $\square$

**Observation 2.4** For a nontrivial graph  $G$ ,

- (i)  $\gamma(G) \leq \gamma_{ns}(G) \leq \gamma_{nsr}(G)$ ;
- (ii)  $2 \leq \gamma_{nsr}(G) \leq n$ .

**Remark 2.5** (i) For any connected graph  $G$ ,  $\gamma_{nsr}(G) = 2$  if and only if there exists a non cut vertex  $v$  such that  $d_G(v) = n - 1$ . Thus  $\gamma_{nsr}(G) = 2$  if and only if  $G = H + K_1$  for some connected graph  $H$ .

(ii) For any connected spanning subgraph  $H$  of  $G$ ,  $\gamma_{nsr}(G) \leq \gamma_{nsr}(H)$ .

**Theorem 2.6** If  $G$  contains a triangle then  $\gamma_{nsr}(G) \leq n - 1$ .

*Proof* Let  $v_1, v_2, v_3$  form a triangle in  $G$ . Then  $f = (\{v_1, v_2\}, V - \{v_1, v_2, v_3\}, \{v_3\})$  is a nonsplit roman dominating function of  $G$  and hence  $\gamma_{nsr}(G) \leq n - 1$ .  $\square$

**Theorem 2.7** Let  $v \in V(G)$  such that  $d_G(v) = \Delta$  and  $\langle N(v) \rangle$  be connected. Then  $\gamma_{nsr}(G) \leq n - \Delta + 1$ .

*Proof* Let us take  $f = (N(v), V - N[v], \{v\})$ . Then it is clear that  $f$  is a nonsplit roman dominating function. Hence  $\gamma_{nsr}(G) \leq |V - N[v]| + 2 = n - (\Delta + 1) + 2 = n - \Delta + 1$ .  $\square$

**Definition 2.8** Let  $f = (V_0, V_1, V_2)$  be a nonsplit roman dominating function and let  $u \in V_i, 0 \leq i \leq 2$ . The function  $f_u$  is defined as follows:

Let  $V_j$  and  $V_k$  be the two sets in the ordered partition  $(V_0, V_1, V_2)$  other than  $V_i$ .

$$V'_l = \begin{cases} V_i - \{u\}, & \text{if } l = i \\ V_j \cup \{u\}, & \text{if } l = j \\ V_k, & \text{if } l = k, 0 \leq l \leq 2. \end{cases},$$

Then the function  $f_u = (V'_0, V'_1, V'_2)$ .

It is clear that for every  $u \in V_i$  there are two functions  $f_u$ .

**Definition 2.9** A nonsplit roman dominating function  $f = (V_0, V_1, V_2)$  is said to be a minimal nonsplit roman dominating function if for every  $u \in V_i, 0 \leq i \leq 2$  either  $w(f_u) > w(f)$  or  $f_u$  is not a nonsplit roman dominating function.

We now proceed to obtain a characterization of minimal nonsplit roman dominating function.

**Theorem 2.10** A nonsplit roman dominating function  $f = (V_0, V_1, V_2)$  is minimal if and only if for each  $u \in V_1$  and  $v \in V_2$  the following conditions are true.

- (i)  $N(u) \cap V_0 = \phi$  or  $N(u) \cap V_2 = \phi$ ;
- (ii) There exists a vertex  $w \in V_0$  such that  $N(w) \cap V_2 = \{v\}$ .

*Proof* Let  $f = (V_0, V_1, V_2)$  be a minimal nonsplit roman dominating function and let  $u \in V_1, v \in V_2$ . Suppose  $N(u) \cap V_0 \neq \phi$  and  $N(u) \cap V_2 \neq \phi$ . Then  $f_u = (V_0 \cup \{u\}, V_1 - \{u\}, V_2)$  is a nonsplit roman dominating function with  $w(f_u) = |V_1| - 1 + 2|V_2| \leq w(f)$  which is a contradiction. Hence either  $N(u) \cap V_0 = \phi$  or  $N(u) \cap V_2 = \phi$ .

Suppose there is no vertex  $w \in V_0$  such that  $N(w) \cap V_2 = \{v\}$ . Then  $f_v = (V_0, V_1 \cup \{v\}, V_2 - \{v\})$  is a nonsplit roman dominating function with  $w(f_v) = |V_1| + 1 + 2(|V_2| - 1) = |V_1| + 2|V_2| - 1 \leq w(f)$  which is a contradiction. Hence for every  $v \in V_2$  there exists a vertex  $w \in V_0$  such that  $N(w) \cap V_2 = \{v\}$ . The converse is straightforward.  $\square$

**Theorem 2.11** For a nontrivial graph  $G$ ,  $\gamma_{nsr}(G) + \omega(G) \leq n + 2$  where  $\omega(G)$  is the clique number of  $G$ .

*Proof* Let  $S$  be a set of vertices of  $G$  such that  $\langle S \rangle$  is complete with  $|S| = \omega(G)$ . Then  $f = (S - \{u\}, V - S, \{u\})$  is a nonsplit roman dominating function of  $G$ . Hence  $\gamma_{nsr}(G) \leq |V - S| + 2 = n - \omega(G) + 2$ . Thus  $\gamma_{nsr}(G) + \omega(G) \leq n + 2$ .  $\square$

**Theorem 2.12** For a graph  $G$ ,  $\gamma_{nsr}(G) \geq 2n - m - 1$ .

*Proof* Let  $f = (V_0, V_1, V_2)$  be a  $\gamma_{nsr}$ -function. Since  $\langle V_0 \rangle$  is connected and every vertex in  $V_0$  is adjacent to at least one vertex in  $V_2$ ,  $\langle V_0 \cup V_2 \rangle$  contains at least  $2|V_0| - 1$  edges.

**Case 1.**  $\langle V_1 \rangle$  is connected.

Then  $\langle V_1 \rangle$  contains at least  $|V_1| - 1$  edges. Since  $G$  is connected there should be an edge between a vertex of  $V_1$  and a vertex of  $V_0 \cup V_2$ . Hence there are at least  $|V_1|$  edges other than the edges in  $\langle V_0 \cup V_2 \rangle$ .

**Case 2.**  $\langle V_1 \rangle$  is disconnected.

Let  $G_1, G_2, \dots, G_k$  be the components of  $\langle V_1 \rangle$ . Since each  $G_i$  contains at least  $|V(G_i)| - 1$  edges and since  $G$  is connected there exists an edge between a vertex of  $G_i$  and a vertex of

$V_0 \cup V_2$ . Hence there are at least  $\Sigma(|V(G_i)| - 1) + k$  ( $= |V_1|$ ) edges.

Hence  $m \geq 2|V_0| - 1 + |V_1| = 2(n - |V_2| - |V_1|) - 1 + |V_1| = 2n - (2|V_2| + |V_1|) - 1 = 2n - \gamma_{nsr}(G) - 1$ . Hence  $\gamma_{nsr}(G) \geq 2n - m - 1$ .  $\square$

**Corollary 2.13** For a tree  $T$ ,  $\gamma_{nsr}(T) = n$ .

*Proof*  $n \geq \gamma_{nsr}(T) \geq 2n - (n - 1) - 1 = n$ . Hence  $\gamma_{nsr}(T) = n$ .  $\square$

**Corollary 2.14** For an unicyclic graph  $G$ ,  $n - 1 \leq \gamma_{nsr}(G) \leq n$ .

**Theorem 2.15** Let  $G$  be an unicyclic graph with cycle  $C = (v_1, v_2, \dots, v_k, v_1)$ . Then  $\gamma_{nsr}(G) = n - 1$  if and only if one of the following is true.

- (i)  $C = C_3$ ;
- (ii)  $d_G(v) \geq 3$  for all  $v \in V(H)$  where  $H$  is a connected subgraph of  $C$  of order at least  $k - 3$ .

*Proof* Let  $G$  be an unicyclic graph with cycle  $C = (v_1, v_2, \dots, v_k, v_1)$ . Let  $C = C_3$ . Then  $G$  contains a triangle and hence by Theorem 2.6,  $\gamma_{nsr}(G) \leq n - 1$  which gives  $\gamma_{nsr}(G) = n - 1$ .

Suppose  $C$  contains a connected subgraph  $H$  such that  $|V(H)| \geq k - 3$  and  $d_G(v) \geq 3$  for all  $v \in V(H)$ . It is clear that  $H$  is either  $C$  or a path. Let  $P$  be a path in  $H$  of order  $k - 3$ . Let  $P = (v_1, v_2, \dots, v_{k-3})$  and let  $u_i \in N(v_i) - V(C)$ ,  $v_i \in V(P)$ . Let  $X = \{u_1, u_2, \dots, u_{k-3}\}$ ,  $V_0 = V(P) \cup \{v_k, v_{k-2}\}$ ,  $V_1 = V(G) - (V(C) \cup X)$ ,  $V_2 = X \cup \{v_{k-1}\}$ . Then  $f = (V_0, V_1, V_2)$  is a nonsplit roman dominating function of  $G$ . Thus  $\gamma_{nsr}(G) \leq n - (k + k - 3) + 2(k - 3 + 1) = n - 1$  and hence  $\gamma_{nsr}(G) = n - 1$ .

Conversely, let us assume  $\gamma_{nsr}(G) = n - 1$ . Let  $f = (V_0, V_1, V_2)$  be a  $\gamma_{nsr}$ -function of  $G$ . Suppose conditions (i) and (ii) given in the statement of the theorem are not true.

Let  $P = (v_1, v_2, \dots, v_{k-3})$  be a path in  $C$  such that  $d_G(v_i) = 2$  for some  $i$ ,  $1 \leq i \leq k - 3$  and  $d_G(v_j) = 2$ ,  $k - 2 \leq j \leq k$ .

**Case 1.**  $i \neq 1$  and  $i \neq k - 3$

Then at least one vertex  $v$  in the subpath  $(v_{i-1}, v_i, v_{i+1})$  with  $f(v) \neq 0$  and at least two vertices  $u$  and  $w$  in the subpath  $(v_{k-3}, v_{k-2}, v_{k-1}, v_k, v_1)$  with  $f(u) \neq 0$  and  $f(w) \neq 0$  and hence either  $\langle V_0 \rangle$  is the union of two distinct paths or  $V_0 = \phi$ . Thus either  $\langle V_0 \rangle$  is disconnected or  $|V_0| = |V_2| = 0$ . Hence  $f$  is not a nonsplit roman dominating function or  $\gamma_{nsr} = n$  which is a contradiction.

**Case 2.**  $i = 1$  or  $i = k - 3$

Let  $d_G(v_i) \geq 3$ ,  $1 \leq i \leq k - 2$  and  $d_G(v_j) = 2$ ,  $k - 3 \leq j \leq k$ . Then at least two vertices  $x$  and  $y$  in  $\{v_{k-3}, v_{k-2}, v_{k-1}, v_k\}$ ,  $d_G(x) \neq 0$  and  $d_G(y) \neq 0$ . Hence for every vertex  $v$  with  $f(v) = 2$  there exists exactly one vertex  $u$  with  $f(u) = 0$ . Thus  $\gamma_{nsr}(G) = n$  which is a contradiction. This proves the result.  $\square$

Now we characterize the lower bound in Theorem 2.3.

**Theorem 2.16** Let  $G$  be a connected graph. Then  $\gamma_{ns} = \gamma_{nsr}(G)$  if and only if  $G$  is a trivial

graph.

*Proof* Let  $f = (V_0, V_1, V_2)$  be a  $\gamma_{nsr}$ -function of  $G$ . Then  $\gamma_{ns}(G) \leq |V_1| + |V_2| \leq |V_1| + 2|V_2| = \gamma_{nsr}(G)$  which gives  $|V_2| = 0$ . Then  $V_0 = \phi$  and hence  $V_1 = V$ . Then  $\gamma_{ns}(G) = \gamma_{nsr}(G) = n$  which gives  $G$  is a trivial graph.  $\square$

**Theorem 2.17** *Let  $G$  be a nontrivial graph of order  $n$ . Then  $\gamma_{nsr}(G) = \gamma_{ns}(G) + 1$  if and only if there exists a vertex  $v \in V(G)$  such that  $\langle N(v) \rangle$  has a component of order  $n - \gamma_{ns}(G)$ .*

*Proof* Let  $v \in V(G)$  such that  $\langle N(v) \rangle$  has a component of order  $n - \gamma_{ns}(G)$ . Let  $G_1$  be the component of  $\langle N(v) \rangle$  with  $|V(G_1)| = n - \gamma_{ns}(G)$ . Let  $V_2 = \{v\}$ ,  $V_1 = V - (V(G_1) \cup \{v\})$  and  $V_0 = V - V_1 - V_2$ . Then  $V_1 \cup V_2$  is a  $\gamma_{ns}$ -set of  $G$  and  $f = (V_0, V_1, V_2)$  is a nonsplit roman dominating function and hence  $\gamma_{nsr}(G) \leq |V_1| + 2|V_2| = n - (n - \gamma_{ns}(G) + 1) + 2 = \gamma_{ns}(G) + 1$ . Since  $G$  is nontrivial  $\gamma_{ns}(G) + 1 \leq \gamma_{nsr}(G)$  and hence  $\gamma_{nsr}(G) = \gamma_{ns}(G) + 1$ .

Conversely, let us assume  $\gamma_{nsr}(G) = \gamma_{ns}(G) + 1$  and let  $f = (V_0, V_1, V_2)$  be a  $\gamma_{nsr}$ -function of  $G$ . Then  $\gamma_{nsr}(G) = |V_1| + 2|V_2|$  which gives  $\gamma_{ns}(G) + 1 = |V_1| + 2|V_2|$ . Then  $|V_1| = \gamma_{ns}(G) + 1 - 2|V_2|$ .

Suppose  $|V_2| \geq 2$ . Since  $V_1 \cup V_2$  is a nonsplit dominating set,  $\gamma_{ns}(G) \leq |V_1| + |V_2| = \gamma_{ns}(G) + 1 - 2|V_2| + |V_2| = \gamma_{ns}(G) + 1 - |V_2| \leq \gamma_{ns}(G) - 1$  which is a contradiction. Hence  $|V_2| \leq 1$ .

If  $|V_2| = 0$  then  $|V_0| = 0$  and hence  $|V_1| = V$ . Thus  $\gamma_{nsr}(G) = n$  and  $\gamma_{ns}(G) = n - 1$ . Then by theorem 1.1  $G$  is a star. Let  $v$  be a pendant vertex of  $G$  and hence  $\langle N(v) \rangle$  is a center vertex of star  $G$ . Thus  $|N(v)| = 1 = n - (n - 1) = n - \gamma_{ns}(G)$ .

Suppose  $|V_2| = 1$ . Let  $V_2 = \{v\}$  and let  $f = (V_0, V_1, V_2)$  be a  $\gamma_{nsr}$ -function of  $G$ . Thus  $\gamma_{nsr} = |V_1| + 2$ . Then  $\gamma_{ns}(G) + 1 - 2 = |V_1|$  which gives  $|V_1| = \gamma_{ns}(G) - 1$ . Hence  $|V_0| = n - |V_1| - |V_2| = n - (\gamma_{ns}(G) - 1) - 1 = n - \gamma_{ns}(G)$  then the result follows.  $\square$

**Corollary 2.18** *For any graph  $G$ , if  $\gamma_{nsr}(G) = \gamma_{ns}(G) + 1$  then  $\text{diam}(G) \leq 4$  and  $\text{rad}(G) \leq 2$ .*

*Proof* Let  $\gamma_{nsr}(G) = \gamma_{ns}(G) + 1$ . Then there is a vertex  $v \in V(G)$  such that  $\langle N(v) \rangle$  has a component of order  $n - \gamma_{ns}(G)$ . Hence every vertex in  $V - N[v]$  is adjacent to a vertex in  $N(v)$ . Thus  $\text{diam}(G) \leq 4$  and  $\text{rad}(G) \leq 2$ .  $\square$

**Corollary 2.19** *If  $T$  is a tree then  $\gamma_{nsr}(T) = \gamma_{ns}(T) + 1$  if and only if  $T$  is a star.*

**Theorem 2.20** *Let  $G$  be an unicyclic graph with the cycle  $C = (v_1, v_2, \dots, v_k, v_1)$ . Then  $\gamma_{nsr}(G) = \gamma_{ns}(G) + 1$  if and only if  $G$  is isomorphic to  $C_3(n_1, n_2, 0)$ .*

*Proof* Let us assume  $\gamma_{nsr}(G) = \gamma_{ns}(G) + 1$ . Then there is a vertex  $v \in V(G)$  such that  $\langle N(v) \rangle$  has a component of order  $n - \gamma_{ns}(G)$ . Let  $G_1$  be a component of  $\langle N(v) \rangle$  such that  $|V(G_1)| = n - \gamma_{ns}(G)$ . If  $|V(G_1)| \geq 3$  then there is a path  $P(u_1, u_2, u_3)$  in  $G_1$ . Then the induced subgraph of the sets  $\{v, u_1, u_2\}$  and  $\{v, u_2, u_3\}$  are cycles which is a contradiction. Hence  $|V(G_1)| = 2$  and hence  $C = C_3$  so that  $C = (v_1, v_2, v_3, v_1)$ . If  $d_G(v_i) \geq 3$  for all  $i$  then  $V - \{v_1, v_2, v_3\}$  is a nonsplit dominating set of  $G$  and hence  $\gamma_{ns}(G) \leq n - 3$  then  $\gamma_{nsr}(G) \leq n - 2$  which is a contradiction. Hence  $d_G(v_i) = 2$  for some  $i$ . Let  $d_G(v_3) = 2$ .



Suppose there is a vertex  $x \in V(G) - V(C)$  such that  $d_G(x) \geq 2$ . Let  $v_1 \in V(C)$  such that  $d(C, x) = d(v_1, x)$ . Let  $(v_1, x_1, x_2, \dots, x_r, x), r \geq 1$  be the shortest  $v_1 - x$  path. Then  $V(G) - \{v_1, v_2, x_1\}$  is a nonsplit dominating set of  $G$  and hence  $\gamma_{ns}(G) \leq n - 3$  which is a contradiction. Hence every vertex in  $V - V(C)$  is a pendant vertex which follows the result.  $\square$

**Theorem 2.21** *Let  $G$  be a nontrivial graph of order  $n$ . Then  $\gamma_{nsr}(G) = \gamma_{ns}(G) + 2$  if and only if*

- (i) every vertex  $v \in V(G)$  such that  $\langle N(v) \rangle$  has no component of order  $n - \gamma_{ns}(G)$ ;
- (ii)  $G$  has a vertex  $v$  such that  $\langle N(v) \rangle$  has a component of order  $n - \gamma_{ns}(G) - 1$  or  $G$  has two vertices  $u$  and  $v$  such that  $\langle N(u) \cup N(v) \rangle$  has a component of order  $n - \gamma_{ns}$ .

*Proof* Let the graph  $G$  be satisfy the conditions (i) and (ii) in the statement of the theorem. By condition (i) and Theorem 2.17,  $\gamma_{nsr}(G) \geq \gamma_{ns}(G) + 2$ . Suppose  $v \in V(G)$  such that  $\langle N(v) \rangle$  has a component  $G_1$  of order  $n - \gamma_{ns}(G) - 1$ . Then  $(V(G_1), V - (V(G_1) \cup \{v\}), \{v\})$  is a nonsplit roman dominating function of  $G$  and hence  $\gamma_{nsr}(G) \leq n - (n - \gamma_{ns}(G) - 1 + 1) + 2 = \gamma_{ns}(G) + 2$ . Hence  $\gamma_{nsr}(G) = \gamma_{ns} + 2$ . Suppose  $G$  has two vertices  $u$  and  $v$  such that  $\langle N(u) \cup N(v) \rangle$  has a component of order  $n - \gamma_{ns}(G)$ . Let  $G_2$  be the component of  $\langle N(u) \cup N(v) \rangle$  with  $|V(G_2)| = n - \gamma_{ns}(G)$ . Let  $V_2 = \{u, v\}, V_1 = V - (V(G_2) \cup \{u, v\})$  and  $V_0 = V - V_1 - V_2 = V(G_2)$ . Then  $V_1 \cup V_2$  is a  $\gamma_{ns}$ -set of  $G$  and  $f = (V_0, V_1, V_2)$  is a nonsplit roman dominating function and hence  $\gamma_{nsr}(G) \leq |V_1| + 2|V_2| = n - (n - \gamma_{ns}(G) + 2) + 4 = \gamma_{ns}(G) + 2$  and hence  $\gamma_{nsr}(G) = \gamma_{ns}(G) + 2$ .

Conversely, let us assume  $\gamma_{nsr}(G) = \gamma_{ns}(G) + 2$  and let  $f = (V_0, V_1, V_2)$  be a  $\gamma_{nsr}$ -function of  $G$ . Then  $\gamma_{nsr}(G) = |V_1| + 2|V_2|$  which gives  $\gamma_{ns}(G) + 2 = |V_1| + 2|V_2|$ . Then  $|V_1| = \gamma_{ns}(G) + 2 - 2|V_2|$ .

Suppose  $|V_2| \geq 3$ . Since  $V_1 \cup V_2$  is a nonsplit dominating set,  $\gamma_{ns}(G) \leq |V_1| + |V_2| = \gamma_{ns}(G) + 2 - 2|V_2| + |V_2| = \gamma_{ns}(G) + 2 - |V_2| \leq \gamma_{ns}(G) - 1$  which is a contradiction. Hence  $|V_2| \leq 2$ .

If  $|V_2| = 0$  then  $|V_0| = 0$  and hence  $|V_1| = V$ . Thus  $\gamma_{nsr}(G) = n$  and  $\gamma_{ns}(G) = n - 2$ . Let  $S$  be a  $\gamma_{ns}$ -set of  $G$ . Then  $\langle V - S \rangle = K_2 = xy$ . Suppose  $|S| = 1$ . Then  $G = C_3$  and hence  $\gamma_{nsr}(G) = 2$  and  $\gamma_{ns}(G) = 1$  which is a contradiction. Thus  $|S| \geq 2$ . Then  $S$  contains two vertices  $u$  and  $v$  which dominates  $x$  and  $y$ . Thus  $G$  contains two vertices  $u$  and  $v$  such that  $\langle N(u) \cup N(v) \rangle$  contains a component of order  $n - \gamma_{ns}(G)$ .

Suppose  $|V_2| = 1$ . Let  $V_2 = \{v\}$ . Then  $\gamma_{nsr} = |V_1| + 2$ . Thus  $\gamma_{ns}(G) + 2 - 2 = |V_1|$  which gives  $|V_1| = \gamma_{ns}(G)$ . Then  $V_0$  contains  $n - \gamma_{ns}(G) - 1$  vertices. Thus  $\langle N(v) \rangle$  has a component a component of order  $n - \gamma_{ns} - 1$ .

Suppose  $|V_2| = 2$ . Let  $V_2 = \{u, v\}$ . Then  $\gamma_{nsr} = |V_1| + 4$ . Thus  $\gamma_{ns}(G) + 2 - 4 = |V_1|$  which gives  $|V_1| = \gamma_{ns}(G) - 2$ . Hence  $|V_0| = n - |V_1| - |V_2| = n - (\gamma_{ns}(G) - 2) - 2 = n - \gamma_{ns}(G)$  then the result follows.  $\square$

**Corollary 2.22** *If  $T$  is a nontrivial tree then  $\gamma_{nsr}(T) = \gamma_{ns}(T) + 2$  if and only if  $T$  has exactly two support vertices.*

*Proof* Let  $T$  be a tree with  $\gamma_{nsr}(T) = \gamma_{ns}(T) + 2$ . Then  $\gamma_{ns}(T) = n - 2$ . Let  $u$  and  $v$  be the support vertices such that  $d(u, v)$  is maximum. Let  $P(u = u_1, u_2, \dots, u_k = v)$  be the  $u - v$

path. Let  $u_i$  be the vertex lie in both  $u - w$  and  $u - v$  paths such that  $i$  is maximum. Then  $V - \{u_{i-1}, u_i, u_{i+1}\}$  is a nonsplit dominating set which is a contradiction. Hence  $T$  contains exactly two support vertices. The converse is obvious.  $\square$

Now we characterize the upper bound in Theorem 2.3.

**Theorem 2.23** *Let  $G$  be a graph. Then  $\gamma_{nsr}(G) = 2\gamma_{ns}(G)$  if and only if  $G$  has a  $\gamma_{nsr}$ -function  $f = (V_0, V_1, V_2)$  with  $|V_1| = 0$ .*

*Proof* Let  $f = (V_0, V_1, V_2)$  be a  $\gamma_{nsr}$ -function and  $|V_1| = 0$ . Then  $V_2$  is a nonsplit dominating set of  $G$ . Suppose, there exists a nonsplit dominating set  $S$  of  $G$  such that  $|S| < |V_2|$ . Then  $g = (V - S, \phi, S)$  is a nonsplit roman dominating function of  $G$  and hence  $\gamma_{nsr}(G) \leq 2|S| < 2|V_2|$  which is a contradiction. Hence  $V_2$  is a  $\gamma_{ns}$ -set of  $G$ . Hence  $\gamma_{nsr}(G) = 2|V_2| = 2\gamma_{ns}(G)$ .

Conversely we assume that  $\gamma_{nsr}(G) = 2\gamma_{ns}(G)$ . Let  $S$  be  $\gamma_{ns}$ -set of  $G$ . Take  $V_0 = V - S, V_1 = \phi, V_2 = S$ . Then  $f = (V_0, V_1, V_2)$  is a nonsplit roman donating function of  $G$  with  $w(f) = 2|V_2| = 2|S| = 2\gamma_{ns}(G)$ . Hence  $f$  is a  $\gamma_{nsr}$ -function of  $G$  with  $|V_1| = 0$ .  $\square$

**Theorem 2.24** *Let  $T$  be a nontrivial tree. Then  $\gamma_{nsr}(T) = 2\gamma_{ns}(T)$  if and only if  $T$  is isomorphic to  $H \circ K_1$  for some tree  $H$ .*

*Proof* Let  $T$  be a tree with  $\gamma_{nsr}(T) = 2\gamma_{ns}(T)$ . Then  $\gamma_{ns}(T) = \frac{n}{2}$ . Let  $S$  be a  $\gamma_{ns}$ -set of  $T$ . Then  $|S| = \frac{n}{2}$ ,  $\langle V - S \rangle$  is connected and  $|V - S| = \frac{n}{2}$ . It is clear that any vertex in  $S$  cannot adjacent to two or more vertices in  $V - S$ . If any two distinct vertices of  $S$  are adjacent to a vertex in  $V - S$  then at least a vertex in  $V - S$  is not dominated by  $S$ . Hence  $T$  is isomorphic to  $H \circ K_1$  for some tree  $H$ . The converse is obvious.  $\square$

Since the graphs  $P_4$  and  $C_5$  are self complementary, the following result is obvious. Hence we omit its proof.

**Theorem 2.25** *Let  $G$  be a graph such that both  $G$  and  $\overline{G}$  are connected. Then  $\gamma_{nsr}(G) + \gamma_{nsr}(\overline{G}) \leq 2n$  and the bound is sharp.*

**Theorem 2.26** *Let  $G$  be a graph such that  $G$  and  $\overline{G}$  are connected and  $diam(G) \geq 5$ . Then  $\gamma_{nsr}(G) + \gamma_{nsr}(\overline{G}) \leq n + 4$ .*

*Proof* Let  $S = \{u, v\}$ , where  $d(u, v) = diam(G)$ . Then  $f = (V - S, \phi, S)$  is a nonsplit roman dominating function of  $\overline{G}$  so that  $\gamma_{nsr}(\overline{G}) \leq 4$  and hence the result follows.  $\square$

**Remark 2.27** The bound given in Theorem 2.28 is sharp. The graph  $G = P_6$  has diameter 5,  $\gamma_{nsr}(G) = 6$  and  $\gamma_{nsr}(\overline{G}) = 4$ . Thus  $\gamma_{nsr}(G) + \gamma_{nsr}(\overline{G}) = 10 = n + 4$ .

**Problem 2.28** *Characterize graphs which attain the bounds given in Theorems 2.25 and 2.26.*

## References

- [1] G.Chartrand and L.Lesniak, *Graphs and Digraphs*, CRC, (2005)

- [2] E.J.Cockayne, P.A.Dreyer Jr, S.M.Hedetniemi and S.T.Hedetniemi, Roman domination in graphs,*Discrete Mathematics*, 278(2004), 11-22.
- [3] T.W.Haynes, S.T.Hedetniemi and P.J.Slater,*Fundamentals of Domination in Graphs*, Marcel Dekker, Inc.,New York,1998.
- [4] T.W.Haynes, S.T.Hedetniemi and P.J.Slater, *Domination in Graphs- Advanced Topics*, Marcel Dekker, Inc.,New York,1998.
- [5] V.R.Kulli and B.Janakiram, The nonsplit domination number of a graph,*Indian Journal of Pure and Applied Mathematics*, 31(5) (2000), 545-550.
- [6] P.Roushni Leely Pushpam and S.Padapriya, Restrained roman domination in graphs,*Transactions on combinatorics*, 4(1)(2015),1-17.
- [7] T.Tamizh Chelvam and B.Jaya Prasad, Complementary connected domination number,*International Journal of Management and Systems*, 18(2)(2002), 147-154.

## A Study on Cayley Graphs of Non-Abelian Groups

A.Riyas and K.Geetha

(T.K.M.College of Engineering, Kollam-691005, India)

E-mail: riyasmaths@gmail.com, rajugeetharaju@gmail.com

**Abstract:** All connected Cayley graphs over Abelian groups are Hamiltonian. However, for Cayley graphs over non-Abelian groups, Chen and Quimpo prove in [2] that Cayley graphs over Hamiltonian groups (i.e, non- Abelian groups in which every subgroup is normal) are Hamiltonian. In this paper we discuss a few of the ideas which have been developed to establish the existence of Hamiltonian cycles and paths in the vertex induced subgraphs of Cayley graphs over non-Abelian groups.

**Key Words:** Cayley graphs, Hamiltonian cycles and paths, complete graph, orbit and centralizer of an element in a group, centre of a group.

**AMS(2010):** 05C25

### §1. Introduction

Let  $G$  be a finite group and  $S$  be a non-empty subset of  $G$ . The graph  $Cay(G, S)$  is defined as the graph whose vertex set is  $G$  and whose edges are the pairs  $(x, y)$  such that  $sx = y$  for some  $s \in S$  and  $x \neq y$ . Such a graph is called the Cayley graph of  $G$  relative to  $S$ . The definition of Cayley graphs of groups was introduced by Arthur Cayley in 1878 and the Cayley graphs of groups have received serious attention since then. Finding Hamiltonian cycles in graphs is a difficult problem, of interest in combinatorics, computer science and applications. In this paper, we present a short survey of various results in that direction and make some observations.

### §2. Preliminaries

In this section deals with the basic definitions of graph theory and group theory which are needed in sequel. A graph  $(V, E)$  is said to be connected if there is a path between any two vertices of  $(V, E)$ . Every pair of arbitrary vertices in  $(V, E)$  can be joined by an edge, then it is complete. A subgraph  $(U, F)$  of a graph  $(V, E)$  is said to be vertex induced subgraph if  $F$  consists of all the edges of  $(V, E)$  joining pairs of vertices of  $U$ . A Hamiltonian path is a path in  $(V, E)$  which goes through all the vertices in  $(V, E)$  exactly once. A hamiltonian cycle is a closed Hamiltonian path. A graph is said to be hamiltonian if it contains a hamiltonian cycle.

Let  $G$  be a group. The orbit of an element  $x$  under  $G$  is usually denoted as  $\bar{x}$  and is defined

---

<sup>1</sup>Received July 12, 2016, Accepted November 10, 2016.

as  $\bar{x} = \{gx/g \in G\}$ . Let  $x$  be a fixed element of  $G$ . The centralizer of an element  $x$  in  $G$ ,  $C_G(x)$ , is the set of all elements in  $G$  that commute with  $x$ . In symbols,  $C_G(x) = \{g \in G/gx = xg\}$ . The centre of a group is denoted as  $Z(G)$  and is defined as  $Z(G) = \{g \in G/gx = xg \forall x \in G\}$ . A group  $G$  acts on  $G$  by conjugation means  $gx = xg^{-1}$  for all  $x \in G$ . An element  $x \in G$  is called an involution if  $x^2 = e$ , where  $e$  is the identity.

**Theorem 2.1** *Let  $G$  be a finite non-Abelian group and  $G$  act on  $G$  by conjugation. Then for  $x \in G$ , the induced subgraph with vertex set  $C_G(x)$  of the Cayley graph  $Cay(G, \bar{x})$  is hamiltonian, provided there exist an element  $a \in \bar{x}$ , which generates  $C_G(x)$ .*

*Proof* Since  $a \in \bar{x}$  which generates  $C_G(x)$ , we have  $C_G(x) = \{a, a^2, a^3, \dots, a^n = e\}$  and  $a \neq e$ , where  $e$  is the identity. Let  $u \in C_G(x)$ . Then  $ux = xu$  for  $x \in G$ . Since  $\bar{x}$  is the orbit of  $x \in G$  and  $G$  act on  $G$  by conjugation, we can choose an element  $s \in \bar{x}$  such that  $s = (ua)a(ua)^{-1}$ .

Now  $su = (ua)a(ua)^{-1}u = (ua)a(a^{-1}u^{-1})u = (ua)aa^{-1}(u^{-1}u) = (ua)aa^{-1}e = (ua)aa^{-1} = (ua)e = ua$ , then there is an edge from  $u$  to  $ua$ . Again,

$$s(ua) = (ua)a(ua)^{-1}(ua) = (ua)a(a^{-1}u^{-1})(ua) = (ua)(aa^{-1})(u^{-1}u)a = (ua)(ea) = ua^2,$$

then there is an edge from  $ua$  to  $ua^2$ , so there exist a path from  $u$  to  $ua^2$ . Continuing in this way, we get a path  $u \rightarrow ua \rightarrow ua^2 \rightarrow ua^3 \rightarrow \dots \rightarrow ua^n = ue = u$  in the induced subgraph with vertex set  $C_G(x)$  of  $Cay(G, \bar{x})$ , which is hamiltonian.  $\square$

**Example 1** Let  $G = S_5$  and let  $x = (123)(45)$ . From the composition table we have  $C_G(x) = \{(), (45), (123), (132), (123)(45), (132)(45)\}$  and  $\bar{x} = \{(123)(45), (124)(35), (125)(34), (132)(45), (134)(25), (135)(24), (142)(35), (143)(25), (145)(23), (152)(34), (153)(24), (154)(23), (15)(234), (14)(235), (15)(243), (13)(245), (14)(253), (13)(254), (12)(345), (12)(354)\}$ . We observe that either  $(123)(45)$  or  $(132)(45)$  in  $\bar{x}$  generates  $C_G(x)$ . Then, Theorem 2.1 implies that the induced subgraph with vertex set  $C_G(x)$  of the Cayley graph  $Cay(G, \bar{x})$  is hamiltonian and is given in Figure 1.

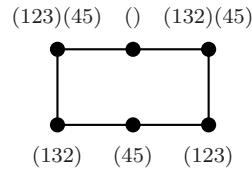

**Figure 1**

**Theorem 2.2** *Let  $G$  be a finite non-Abelian group and  $G$  act on  $G$  by conjugation. Then for  $x \in G$ , the induced subgraph with vertex set  $C_G(x)$  of the Cayley graph  $Cay(G, \bar{x})$  is Hamiltonian, provided  $\bar{x}$  contains two involutions  $a$  and  $b$  which generates  $C_G(x)$  and they commute.*

*Proof* Since  $\bar{x}$  has two involutions  $a$  and  $b$  which generates  $C_G(x)$ , we have  $C_G(x) = \{a, b, ab, e\}$ . Let  $u \in C_G(x)$ . Then  $ux = xu$  for  $x \in G$ . Since  $\bar{x}$  is the orbit of  $x \in G$

and  $G$  act on  $G$  by conjugation, we can choose two involutions  $s_1$  and  $s_2$  in  $\bar{x}$  such that  $s_1 = (ua)a(ua)^{-1}$  and  $s_2 = (ub)b(ub)^{-1}$ . Now  $s_1u = (ua)a(ua)^{-1}u = (ua)a(a^{-1}u^{-1})u = (ua)(aa^{-1})(u^{-1}u) = ((ua)e)e = ua$ , so there is an edge from  $u$  to  $ua$ . Again  $s_2(ua) = (ub)b(ub)^{-1}ua = (ub)b(b^{-1}u^{-1})ua = (ub)(bb^{-1})(u^{-1}u)a = ((ub)e)ea = uba = uab$ , then there is an edge from  $ua$  to  $uab$ , so there exist a path from  $u$  to  $uab$ . Again  $s_1(uab) = (ua)a(ua)^{-1}(uab) = (ua)a(a^{-1}u^{-1})(uab) = (ua)(aa^{-1})(u^{-1}u)ab = ((ua)e)eaab = (ua)ab = u(aa)b = (ue)b = ub$ , so there is an edge from  $uab$  to  $ub$ . Again  $s_2(ub) = (ub)b(ub)^{-1}(ub) = (ub)be = ub^2 = ue = u$ . Thus we get a Hamiltonian cycle  $u \rightarrow ua \rightarrow uab \rightarrow ub \rightarrow u$  in the induced subgraph with vertex set  $C_G(x)$  of the Cayley graph  $Cay(G, \bar{x})$ .  $\square$

**Example 2** Let  $G = S_4$  and let  $x = (13)$ . From the composition table we have  $C_G(x) = \{(), (13), (24), (13)(24)\}$  and  $\bar{x} = \{(12), (13), (14), (23), (24), (34)\}$ . We can observe that  $\bar{x}$  has two involutions (13) and (24) which generates  $C_G(x)$  and  $(13)(24) = (24)(13)$ . Then, Theorem 2.2 implies that the induced subgraph with vertex set  $C_G(x)$  of the Cayley graph  $Cay(G, \bar{x})$  is Hamiltonian and is given in Figure 2.

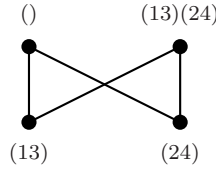

**Figure 2**

**Theorem 2.3** Let  $G$  be a finite non-Abelian group and  $G$  act on  $G$  by conjugation. Then for  $x \in G$ , the induced subgraph with vertex set  $C_G(x)$  of the Cayley graph  $Cay(G, \bar{x})$  has disjoint Hamiltonian cycles, provided  $\bar{x}$  has three elements  $a, b, c$  which do not generate  $C_G(x)$  and they together with identity is isomorphic to  $V_4$ , the Klein-4 group.

*Proof* We have  $\{e, a, b, c\} \cong V_4$ , so  $ab = ba = c, bc = cb = a, ac = ca = b$  and  $a, b, c$  are involutions. Since  $\bar{x}$  has three elements  $a, b, c$  which do not generate  $C_G(x)$ , we see that  $x \neq e$ . To prove that the induced subgraph with vertex set  $C_G(x)$  of the Cayley graph  $Cay(G, \bar{x})$  has disjoint hamiltonian cycles, it is enough to show that there exist at least two closed disjoint hamiltonian paths in it. Let  $u \in \{e, a, b, c\}$ . Since  $\bar{x}$  is the orbit of  $x \in G$  and  $G$  act on  $G$  by conjugation, we can choose two elements  $s_1, s_2 \in \bar{x}$  such that  $s_1 = (ua)a(ua)^{-1}$  and  $s_2 = (ub)b(ub)^{-1}$ . Now  $s_1u = (ua)a(ua)^{-1}u = (ua)a(a^{-1}u^{-1})u = (ua)(aa^{-1})(u^{-1}u) = ((ua)e)e = ua$  then there is an edge from  $u$  to  $ua$ . Again  $s_2(ua) = (ub)b(ub)^{-1}ua = (ub)b(b^{-1}u^{-1})ua = (ub)(bb^{-1})(u^{-1}u)a = ((ub)e)ea = uba = uc$  then there is an edge from  $ua$  to  $uc$ , consequently there exist a path from  $u$  to  $uc$ . Again  $s_1(uc) = (ua)a(ua)^{-1}(uc) = (ua)a(a^{-1}u^{-1})(uc) = (ua)(aa^{-1})(u^{-1}u)c = ((ua)e)c = uac = ub$ , so there is an edge from  $uc$  to  $ub$  and hence there exist a path from  $u$  to  $ub$ . Again  $s_2(ub) = (ub)b(ub)^{-1}(ub) = (ub)b(b^{-1}u^{-1})(ub) = (ub)(bb^{-1})(u^{-1}u)b = ((ub)e)b = ubb = ue = u$ . Thus we get a hamiltonian cycle  $C_1 : u \rightarrow ua \rightarrow$

$uc \rightarrow ub \rightarrow u$  in the induced subgraph with vertex set  $C_G(x)$  of the Cayley graph  $Cay(G, \bar{x})$ . In particular, for  $u = a$ , we get a hamiltonian cycle  $a \rightarrow e \rightarrow b \rightarrow c \rightarrow a$ .

Since  $a, b, c$  do not generate  $C_G(x)$ , clearly  $C_G(x)$  contains at least one element  $u_1 \notin V_4$ . Now  $s_1 u_1 = (ua)a(ua)^{-1}u_1 = (ua)a(a^{-1}u^{-1})u_1 = (ua)(aa^{-1})(u^{-1}u_1) = (ua)e(u^{-1}u_1) = (ua)(u^{-1}u_1)$ . Since  $u \in V_4$ , we have  $ua = au$ , then  $(ua)(u^{-1}u_1) = (au)(u^{-1}u_1) = a(uu^{-1})u_1 = (ae)u_1 = au_1$ . Clearly  $au_1 \notin V_4$ . For if  $au_1 \in V_4$ , then  $au_1 = u_2 \in V_4$ , which implies  $u_1 = a^{-1}u_2 \in V_4$ , it is a contradiction to our assumption that  $u_1 \notin V_4$ . So there exist an edge from  $u_1$  to  $au_1$ . Again  $s_2(au_1) = (ub)b(ub)^{-1}(au_1) = (ub)b(b^{-1}u^{-1})(au_1) = (ub)(bb^{-1})u^{-1}(au_1) = (ub)eu^{-1}(au_1) = (ub)u^{-1}(au_1) = (bu)u^{-1}(au_1) = b(uu^{-1})(au_1) = be(au_1) = bau_1 = cu_1$ , as above we can show that  $cu_1 \notin V_4$ . Thus there exist an edge from  $au_1$  to  $cu_1$  and consequently a path from  $u_1$  to  $cu_1$ . Also  $s_1(cu_1) = (ua)a(ua)^{-1}(cu_1) = (ua)a(a^{-1}u^{-1})(cu_1) = (ua)(aa^{-1})u^{-1}(cu_1) = (ua)eu^{-1}(cu_1) = (ua)u^{-1}(cu_1) = (au)u^{-1}(cu_1) = a(uu^{-1})(cu_1) = ae(cu_1) = acu_1 = bu_1$ . Here also  $bu_1 \notin V_4$ , so there is a path from  $u_1$  to  $bu_1$ . Again  $s_2(bu_1) = (ub)b(ub)^{-1}(bu_1) = (ub)b(b^{-1}u^{-1})(bu_1) = (ub)(bb^{-1})u^{-1}(bu_1) = (ub)eu^{-1}(bu_1) = (ub)u^{-1}(bu_1) = (bu)u^{-1}(bu_1) = b(uu^{-1})(bu_1) = be(bu_1) = (bb)u_1 = eu_1 = u_1$ . Thus we get another hamiltonian cycle  $C_2 : u_1 \rightarrow au_1 \rightarrow cu_1 \rightarrow bu_1 \rightarrow u_1$  in the induced subgraph with vertex set  $C_G(x)$  of the Cayley graph  $Cay(G, \bar{x})$ , which is disjoint from  $C_1$ .  $\square$

**Example 3** Let  $G = S_4$  and let  $x = (12)(34)$ . From the composition table we have  $C_G(x) = \{(), (12), (34), (12)(34), (13)(24), (14)(23), (1324), (1423)\}$  and  $\bar{x} = \{(12)(34), (13)(24), (14)(23)\}$ . We can observe that  $\bar{x}$  has three elements which do not generate  $C_G(x)$  and they together with identity is  $V_4$  in  $S_4$ . Then, Theorem 2.3 implies that the induced subgraph with vertex set  $C_G(x)$  of the Cayley graph  $Cay(G, \bar{x})$  has disjoint hamiltonian cycles and are given in Figure 3.

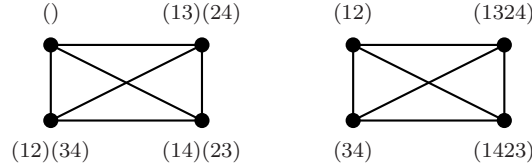

**Figure 3**

**Theorem 2.4** Let  $G$  be a finite non-Abelian group and  $G$  act on  $G$  by conjugation. Then for  $x \in G$ , the induced subgraph with vertex set  $C_G(x)$  of the Cayley graph  $Cay(G, \bar{x})$  has two complete hamiltonian cycles, one with vertex set  $P_1$  and other with vertex set  $P_2$ , provided  $C_G(x)$  has a partition  $(P_1, P_2)$ , where  $\bar{x}$  generates  $P_1 \cong V_4$  and  $P_2$  is the generating set of  $P_1$ .

*Proof* Since  $P_1 \cong V_4$  and  $\bar{x}$  generates  $P_1$ , we have  $P_1 = \{e, u_1, u_2, u_3\}$ . Then by Theorem 2.3, for every  $u \in P_1$ , we get a hamiltonian cycle  $C_1 : u \rightarrow uu_1 \rightarrow uu_3 \rightarrow uu_2 \rightarrow u$  in the induced subgraph with vertex set  $P_1$  of the Cayley graph  $Cay(G, \bar{x})$ . To prove that it is complete, it is

enough to show that every pair of vertices in  $P_1$  has an edge. Let  $u_1$  and  $u_2$  are two arbitrary vertices in  $P_1$ . Since  $\bar{x}$  is the orbit of  $x \in G$  and  $G$  act on  $G$  by conjugation, we can choose an element  $s \in \bar{x}$  such that  $s = (u_1u_2)(u_1^{-1}u_2)(u_1u_2)^{-1}$ . Now  $su_1 = (u_1u_2)(u_1^{-1}u_2)(u_1u_2)^{-1}u_1 = (u_1u_2)(u_1^{-1}u_2)(u_2^{-1}u_1^{-1})u_1 = (u_1u_2)u_1^{-1}(u_2u_2^{-1})(u_1^{-1}u_1) = (u_1u_2)u_1^{-1}e = (u_1u_2)u_1^{-1} = (u_2u_1)u_1^{-1} = u_2(u_1u_1^{-1}) = u_2e = u_2$ . Thus there exist an edge from  $u_1$  to  $u_2$  and hence it is complete.

Since  $P_2$  is the generating set of  $P_1$ , we have  $P_2P_2 = P_1, P_2P_1 = P_2, P_1P_2 = P_2, P_1P_1 = P_1$ . Let  $u_4 \in P_2$ . Since  $\bar{x}$  is the orbit of  $x \in G$  and  $G$  act on  $G$  by conjugation, we can choose two elements  $s_1, s_2 \in \bar{x}$  such that  $s_1 = (uu_1)u_1(uu_1)^{-1}$  and  $s_2 = (uu_2)u_2(uu_2)^{-1}$  for  $u \in P_1$ .

Now  $s_1u_4 = (uu_1)u_1(uu_1)^{-1}u_4 = (uu_1)u_1(u_1^{-1}u^{-1})u_4 = (uu_1)(u_1u_1^{-1})u^{-1}u_4 = (uu_1)eu^{-1}u_4 = (uu_1)u^{-1}u_4 = (u_1u)u^{-1}u_4 = u_1(uu^{-1})u_4 = u_1eu_4 = u_1u_4$ . Clearly  $u_1u_4 \notin P_1$ , since  $P_1P_2 = P_2$ . So there is an edge from  $u_4$  to  $u_1u_4$ .

Again

$$\begin{aligned} s_2(u_1u_4) &= (uu_2)u_2(uu_2)^{-1}(u_1u_4) = (uu_2)u_2(u_2^{-1}u^{-1})(u_1u_4) \\ &= (uu_2)(u_2u_2^{-1})u^{-1}(u_1u_4) = (uu_2)eu^{-1}(u_1u_4) \\ &= (u_2u)u^{-1}(u_1u_4) = u_2(uu^{-1})u_1u_4 \\ &= u_2e(u_1u_4) = (u_2u_1)u_4 = u_3u_4, \end{aligned}$$

as above we can show that  $u_3u_4 \notin P_1$ . Thus there is an edge from  $u_1u_4$  to  $u_3u_4$  and consequently a path from  $u_4$  to  $u_3u_4$ .

Also

$$\begin{aligned} s_1(u_3u_4) &= (uu_1)u_1(uu_1)^{-1}(u_3u_4) = (uu_1)u_1(u_1^{-1}u^{-1})(u_3u_4) = (uu_1)(u_1u_1^{-1})u^{-1}(u_3u_4) \\ &= (uu_1)eu^{-1}(u_3u_4) = (uu_1)u^{-1}(u_3u_4) = (u_1u)u^{-1}(u_3u_4) \\ &= u_1(uu^{-1})(u_3u_4) = u_1e(u_3u_4) = (u_1u_3)u_4 = u_2u_4. \end{aligned}$$

Here also  $u_2u_4 \notin P_1$ , so there exist a path from  $u_4$  to  $u_2u_4$ .

Again

$$\begin{aligned} s_2(u_2u_4) &= (uu_2)u_2(uu_2)^{-1}(u_2u_4) = (uu_2)u_2(u_2^{-1}u^{-1})(u_2u_4) \\ &= (uu_2)(u_2u_2^{-1})u^{-1}(u_2u_4) = (uu_2)eu^{-1}(u_2u_4) = (u_2u)u^{-1}(u_2u_4) \\ &= u_2(uu^{-1})(u_2u_4) = u_2e(u_2u_4) = (u_2u_2)u_4 = eu_4 = u_4. \end{aligned}$$

Thus we get another hamiltonian cycle  $C_2 : u_4 \rightarrow u_1u_4 \rightarrow u_3u_4 \rightarrow u_2u_4 \rightarrow u_4$  in the induced subgraph with vertex set  $P_2$  of the Cayley graph  $Cay(G, \bar{x})$ , which is disjoint from  $C_1$ . Let  $u_4, u_5 \in P_2$ . We can choose an element  $s \in \bar{x}$  such that  $s = (u_4u_5^{-1})(u_5u_4^{-1})(u_4u_5^{-1})^{-1}$ . Then  $su_4 = (u_4u_5^{-1})(u_5u_4^{-1})(u_4u_5^{-1})^{-1}u_4 = u_4(u_5^{-1}u_5)u_4^{-1}u_5(u_4^{-1}u_4) = (u_4e)u_4^{-1}u_5e = (u_4u_4^{-1})u_5 = eu_5 = u_5$ . Thus for any two arbitrary elements  $u_4, u_5 \in P_2$  is connected by an edge, so the induced subgraph with vertex set  $P_2$  of the Cayley graph  $Cay(G, \bar{x})$  is complete.  $\square$

**Example 4** Let  $G = S_5$  and let  $x = (12)(34)$ . From the composition table we have  $C_G(x) =$



$\{(), (12), (34), (12)(34), (13)(24), (14)(23), (1324), (1423)\}$  and  $\bar{x} = \{(12)(34), (12)(35), (12)(45), (14)(23), (13)(24), (13)(25), (13)(45), (14)(25), (14)(35), (15)(23), (15)(24), (15)(34), (23)(45), (25)(34), (24)(35)\}$ . We can observe that  $C_G(x)$  has a partition  $(P_1, P_2)$  where  $P_1 = \{(), (12)(34), (13)(24), (14)(23)\}$ , which is  $V_4$  in  $S_5$  and  $P_2$  is the generating set of  $P_1$ . Then, Theorem 2.4 implies that the induced subgraph with vertex set  $C_G(x)$  of the Cayley graph  $Cay(G, \bar{x})$  has two complete Hamiltonian cycles and are given in Figure 4.

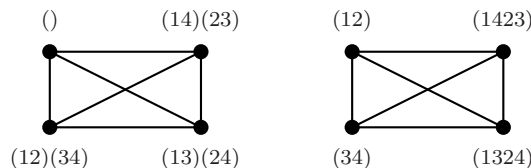

Figure 4

**Theorem 2.5** *Let  $G$  be a finite non-Abelian group and  $G$  act on  $G$  by conjugation. Then for  $x \in G$ , the induced subgraph with vertex set  $C_G(x)$  of the Cayley graph  $Cay(G, \bar{x} \cup V_4)$  is complete, provided there exist an element  $a \in \bar{x}$ , which generates  $C_G(x)$  and  $|C_G(x)| \leq 4$ .*

*Proof* Since  $a \in \bar{x}$  which generates  $C_G(x)$  with  $|C_G(x)| \leq 4$ , by Theorem 2.1, for  $u \in C_G(x)$  we get a hamiltonian path  $u \rightarrow ua \rightarrow ua^2 \rightarrow ua^3 \rightarrow ua^4 = ue = u$  in the induced subgraph with vertex set  $C_G(x)$  of the Cayley graph  $Cay(G, \bar{x})$ . Then clearly the induced subgraph with vertex set  $C_G(x)$  of the Cayley graph  $Cay(G, \bar{x} \cup V_4)$  is hamiltonian. Since the graph is hamiltonian, we know that there exist an edge from  $ua^i$  to  $ua^{i+1}$ . To prove that this graph is complete, it is enough to show that there exist an edge from  $ua^i$  to  $ua^{i+2}$  for  $i = 0, 1$ . We can choose an element  $s \in V_4$  such that  $s = ua^2u^{-1}$ . Now  $s(ua^i) = ua^2u^{-1}(ua^i) = ua^{i+2}$ . So there exist an edge from  $ua^i$  to  $ua^{i+2}$ . Thus the graph is complete.  $\square$

**Example 5** Let  $G = S_5$  and let  $x = (1423)$ . From the composition table we have  $C_G(x) = \{(), (12)(34), (1423), (1324)\}$  and  $\bar{x} = \{(1234), (1235), (1245), (1423), (1523), (2345), (1534), (2534), (1342), (1352), (1452), (1432), (1532), (2453), (1543), (2543), (1354), (1324), (1325), (1345), (1425), (1435), (1524), (2435), (1254), (1243), (1253), (2354), (1542), (1453)\}$ . We can observe that either  $(1423)$  or  $(1324)$  in  $\bar{x}$  generates  $C_G(x)$  with  $|C_G(x)| \leq 4$ . Then, Theorem 2.5 implies that the induced subgraph with vertex set  $C_G(x)$  of the Cayley graph  $Cay(G, \bar{x} \cup V_4)$  is complete and is given in Figure 5.

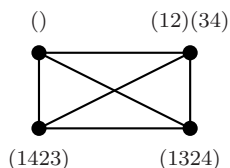

Figure 5

**Theorem 2.6** *Let  $G$  be a finite non-Abelian group and  $G$  act on  $G$  by conjugation. Then for  $x \in G$ , the induced subgraph with vertex set  $C_G(x)$  of the Cayley graph  $Cay(G, \bar{x} \cup V_4)$  is complete, provided there exist two involutions  $a, b \in \bar{x}$  satisfy the conditions  $ab = ba$  and  $(ab)^2 = e$ , which generates  $C_G(x)$ .*

*Proof* Since  $\bar{x}$  contains two involutions  $a$  and  $b$  which generates  $C_G(x)$  and  $ab = ba$ , by Theorem 2.2 we get a hamiltonian path  $u \rightarrow ua \rightarrow uab \rightarrow ub \rightarrow u$  in the induced subgraph with vertex set  $C_G(x)$  of the Cayley graph  $Cay(G, \bar{x})$ . Then clearly the induced subgraph with vertex set  $C_G(x)$  of the Cayley graph  $Cay(G, \bar{x} \cup V_4)$  is hamiltonian. To prove that it is complete, it is enough to show that there exist edges from  $u$  to  $uab$  and  $ua$  to  $ub$ . Since  $V_4$  is the klein-4 group, we can choose an element  $s \in V_4$  such that  $s = u(ab)u^{-1}$ . Now  $su = u(ab)u^{-1}u = (uab)(u^{-1}u) = uabe = uab$ , so there is an edge from  $u$  to  $uab$ .

Similarly  $s(ua) = u(ab)u^{-1}(ua) = uab(u^{-1}u)a = uab(ea) = u(ab)a = u(ba)a = uba^2 = ube = ub$ , so there is an edge from  $ua$  to  $ub$ . Thus the induced subgraph with vertex set  $C_G(x)$  of the Cayley graph  $Cay(G, \bar{x} \cup V_4)$  is complete.  $\square$

**Example 6** Let  $G = S_4$  and let  $x = (13)$ . By Example 2, we get a hamiltonian cycle in the induced subgraph with vertex set  $C_G(x)$  of the Cayley graph  $Cay(G, \bar{x})$ . If we add  $(13)(24) \in V_4$  in  $\bar{x}$ , then it makes the graph complete and is given in Figure 6.

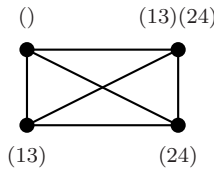

**Figure 6**

**Theorem 2.7** *Let  $G$  be a finite non-Abelian group and  $G$  act on  $G$  by conjugation. Then for  $x \in G$ , where  $x$  is not an involution, the induced subgraph with vertex set  $C_G(x)$  of the Cayley graph  $Cay(G, \bar{x})$  is hamiltonian provided  $|C_G(x)| \leq 5$ .*

*Proof* Since  $x$  is not an involution, we see that  $x \neq e$ , where  $e$  is the identity. Let  $u \in C_G(x)$ . Then  $ux = xu$  for  $x \in G$ . Since  $\bar{x}$  is the orbit of  $x \in G$  and  $G$  act on  $G$  by conjugation, we can choose an element  $s = (ux)x(ux)^{-1} \in \bar{x}$  such that  $s \in \bar{x} \cap C_G(x)$ . Now  $su = (ux)x(ux)^{-1}u = (ux)x(x^{-1}u^{-1})u = (ux)xx^{-1}(u^{-1}u) = (ux)xx^{-1}e = (ux)xx^{-1} = (ux)e = ux$ . Then there is an edge from  $u$  to  $ux$ . Again  $s(ux) = (ux)x(ux)^{-1}(ux) = (ux)x(e) = (ux)x = ux^2$ , then there is an edge from  $ux$  to  $ux^2$  so there exist a path from  $u$  to  $ux^2$ . Continuing in this way, we get a path from  $u$  to  $ux^i$  for  $i \in N$ . Since  $G$  is finite and  $x \in G$ , we have  $ux^i = ux^j$  for some  $i$  and  $j$ . Now  $(ux^j)x^{-i} = (ux^i)x^{-i} = ue = u$ . Thus the induced subgraph with vertex set  $C_G(x)$  of the Cayley graph  $Cay(G, \bar{x})$  is hamiltonian.  $\square$

**Example 7** Let  $G = S_5$  and let  $x = (13245)$ . From the composition table we have  $C_G(x) = \{(), (15423), (13245), (12534), (14352)\}$  and  $\bar{x} = \{(12345), (14532), (12435), (15423), (13245),$

$(15324), (15243), (12453), (14325), (15432), (13452), (14523), (15342), (12534), (13425), (14235), (13542), (15234), (14352), (13254), (12354), (14253), (12543), (13524)\}$ . We observe that  $x^2 \neq e$  with  $|C_G(x)| \leq 5$ . Then, Theorem 2.7 implies that the induced subgraph with vertex set  $C_G(x)$  of the Cayley graph  $Cay(G, \bar{x})$  is hamiltonian and is given in Figure 7.

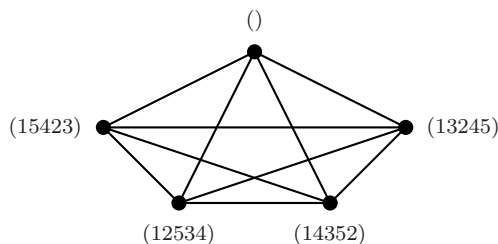

Figure 7

**Theorem 2.8** Let  $G$  be a finite non-Abelian group and  $N$  be a non-trivial normal subgroup of  $G$ . Then  $Cay(\frac{G}{N}, Z(\frac{G}{N}))$  is complete, provided  $Z(\frac{G}{N}) \neq e$ .

*Proof* Let  $u, v \in \frac{G}{N}$  with  $u \neq v$ . Then  $u = g_1h$  and  $v = g_2h$  for  $g_1, g_2 \in G$  and  $h \in N$ . Since  $s \in Z(\frac{G}{N})$  and  $Z(\frac{G}{N}) \neq e$ , we have an element  $s = (g_1^{-1}g_2)h \in Z(\frac{G}{N})$  such that  $sx = xs$  for every  $x \in Z(\frac{G}{N})$ . Now  $su = (g_1^{-1}g_2)h(g_1h) = (g_1h)(g_1^{-1}g_2)h = ((g_1g_1^{-1})g_2)h = (eg_2)h = g_2h = v$ . So for any two arbitrary vertices  $u, v$  in  $\frac{G}{N}$  has an edge. Thus the Cayley graph  $Cay(\frac{G}{N}, Z(\frac{G}{N}))$  is complete.  $\square$

**Example 8** Let  $G = S_4$ . We observe that  $Cay(\frac{G}{A_4}, Z(\frac{G}{A_4}))$  is complete where as  $Cay(\frac{G}{V_4}, Z(\frac{G}{V_4}))$  is not, since  $Z(\frac{G}{V_4}) = e$ .

Suppose  $G = D_4$ . We have  $N = ((), (13)(24))$  is a normal subgroup of  $G$  with  $Z(\frac{D_4}{N}) \neq e$ . Then, Theorem 2.8 implies that  $Cay(\frac{G}{N}, Z(\frac{G}{N}))$  is complete and is shown in Figure 8.

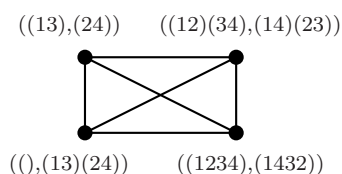

Figure 8

References

[1] Bermond J.C., Hamilton decomposition of graphs, directed graphs and hypergraphs, in: *Advances of Graph Theory, Ann. Discrete Math.*, 3(1978), 21- 28.  
 [2] Chen C.C., Quimpo N.F., *Hamilton Cycles in Cayley graphs over Hamilton groups*, Research Report No.80, Lee Kong Chian Centre for Mathematical Research, National University of Singapore(1983).

- [3] Chen C.C., On edge-hamiltonian property of Cayley graphs, *Discrete Math.*, 72(1988), 29-33.
- [4] Chen C.C., Quimpo N.F., On some classes of Hamiltonian groups, *Southeast Asian Bull.Math.*, Special issue (1979), 252-258.
- [5] Chen C.C., Quimpo N.F., On strongly Hamiltonian abelian group graphs, in: K.L. McAvaney, ed., *Combinatorial Mathematics VIII, Lecture Notes in Mathematics*, Vol.884, Springer, Berlin, 1981, 23-34.
- [6] Curran S.J., Gallian J.A., Hamiltonian cycles and paths in Cayley graphs and digraphs - a survey, *Discrete Math.*, 156(1996), 1-18.
- [7] Gallai T., *On directed paths and circuits*, in *Theory of Graphs, Proc. Colloq., Tihany* (1966), 115-118, Academic Press, New York, 1968.
- [8] Joseph A. Gallian, *Contemporary Abstract Algebra*, Fourth Edition, Narosa publications.
- [9] Witte, D., Gallian, J.A., A survey: hamiltonian cycles in Cayley graphs, *Discrete Math.*, 51(1984), 293-304.

## On Linear Operators Preserving Orthogonality of Matrices over Fuzzy Semirings

Yizhi Chen

(Department of Mathematics, Huizhou University, Huizhou, Guangdong, 516007, China)

Jing Tian

(Shcool of Economics and Finance, Xi'an International Studies University, Xi'an, 710128, China)

E-mail: yizhichen1980@126.com, ttianjing@qq.com

**Abstract:** In this paper, we investigate the linear operators preserving orthogonality of matrices over fuzzy semirings. We firstly characterize invertible linear operators preserving orthogonality of fuzzy matrices. And then, based on the obtained results, we study the invertible linear operators preserving orthogonality of matrices over the direct product of fuzzy semirings, and give some complete characterizations.

**Key Words:** Linear operator; orthogonality; fuzzy semirings.

**AMS(2010):** 15A04, 15A09, 16Y60

### §1. Introduction

Let  $\mathbb{F} = [0, 1]$  be a set of reals between 0 and 1 with addition (+), and multiplication ( $\cdot$ ) and the ordinary order  $\leq$  such that

$$x + y = \max\{x, y\} \text{ and } x \cdot y = \min\{x, y\}$$

for all  $x, y \in \mathbb{F}$ . We call  $\mathbb{F}$  a fuzzy semiring. For any  $x, y \in \mathbb{F}$ , we omit the dot of  $x \cdot y$  and simply write  $xy$ .

Let  $M_n(\mathbb{F})$  denote the set of all  $n \times n$  matrices over  $\mathbb{F}$ . Define + and  $\cdot$  on  $M_n(\mathbb{F})$  as follows:

$$(\forall A, B \in M_n(\mathbb{F})) \quad A + B = [a_{ij} + b_{ij}]_{n \times n}, \quad A \cdot B = \left[ \sum_{k=1}^n a_{ik} b_{kj} \right]_{n \times n}.$$

It is easy to verify that  $(M_n(\mathbb{F}), +, \cdot)$  is a semiring with the operations defined above. And the matrices in  $(M_n(\mathbb{F}), +, \cdot)$  are called fuzzy matrices.

Let  $\mathbb{F}$  be a fuzzy semiring and  $A \in M_n(\mathbb{F})$ . We denote the transpose of  $A$  by  $A^t$  and the entry of  $A$  in the  $i$ th row and  $j$ th column by  $a_{ij}$ .

---

<sup>1</sup>Supported by Grants of the NNSF of China Nos.11501237, 11401246, 11426112, 61402364, the NSF of Guangdong Province Nos.2014A030310087, 2014A030310119, 2016A030310099, the Outstanding Young Teacher Training Program in Guangdong Universities No.YQ2015155, Scientific research innovation team Project of Huizhou University (hzuxl201523).

<sup>2</sup>Received June 19, 2016, Accepted November 12, 2016.

For any  $A \in M_n(\mathbb{F})$  and any  $\lambda \in \mathbb{F}$ , we define

$$\lambda A = [\lambda a_{ij}]_{n \times n}.$$

A mapping  $T : M_n(\mathbb{F}) \rightarrow M_n(\mathbb{F})$  is called a *linear operator* if

$$T(aA + bB) = aT(A) + bT(B)$$

for all  $a, b \in \mathbb{F}$  and  $A, B \in M_n(\mathbb{F})$ . Notice that if  $T$  is a linear operator on  $M_n(\mathbb{F})$ , then  $T(O) = O$ .

$A, B$  in  $M_n(\mathbb{F})$  are said to be orthogonal (see [?]) if  $AB = BA = O$ . Let  $T$  be an operator on  $M_n(\mathbb{F})$ . We say that  $T$  preserves orthogonality if  $T(A)$  and  $T(B)$  are orthogonal whenever  $A$  and  $B$  are orthogonal.

During the past 100 years, one of the most active and fertile subjects in matrix theory is the linear preserver problem (LPP for short), which concerns the characterization of linear operators on matrix spaces that leave certain functions, subsets, relations, etc., invariant. The first paper can be traced down to Frobenius's work in 1897. Since then, a number of works in the area have been published. Among these works, although the linear operators concerned are mostly linear operators on matrix spaces over some fields or rings, the same problem has been extended to matrices over various semirings.

Many authors have studied the linear operators that preserve invariants of matrices over semirings. For example, idempotent preservers were investigated by Song, Kang and Beasley ([16]), Dolžan and Oblak ([6]), Orel ([14]) et al. Nilpotent preservers were discussed by Song, Kang and Jun ([19]), Li and Tan ([12]) et al. Regularity preservers were studied by Song, Kang, Jun, Beasley and Sze in [10] and [21] et al. Pshenitsyna ([15]) considered invertibility preservers. Besides, Beasley, Guterman, Jun and Song ([1]) investigated the linear preservers of extremes of rank inequalities over semirings, Beasley and Lee ([2]) studied the linear operators that strongly preserve  $r$ -potent matrices over semirings, Song and Kang ([20]) discussed commuting pairs of matrices preservers and so on.

The linear preserver problems about orthogonality of matrices are more and more caused people's attention. In [17] and [18], Šemrl studied maps on idempotents matrices that preserve orthogonality over a division ring. Burgos et al. ([3]) studied orthogonality preserving operators between  $C^*$ -algebras,  $JB^*$ -algebras and  $JB^*$ -triples. Cui, Hou and Park ([5]) described the additive maps preserving the indefinite orthogonality of operators acting on indefinite inner product spaces. Also, there are some literature on maps that approximately preserve orthogonality (see [4],[9] et al).

Note that the researches about linear operators preserving orthogonality of matrices over semiring are not much, and fuzzy semirings are the ones which have bright background. In this paper our purpose is to obtain characterizations of invertible linear operators that preserve orthogonality matrices over fuzzy semirings. In Section 2 we characterize invertible linear operators preserving orthogonality of fuzzy matrices. Based on the obtained results, we study the invertible linear operators preserving orthogonality of matrices over the direct product of fuzzy semirings in Sections 3, and obtain some complete characterizations.

For notations and terminologies occurred but not mentioned in this paper, the readers are referred to [8].

## §2. Linear Operators Preserving Orthogonality of Fuzzy Matrices

In this section, we will study the complete characterizations of linear operators that preserve orthogonality of fuzzy matrices.

Let  $\mathbb{S}$  be a semiring. A matrix  $P \in M_n(\mathbb{S})$  is called a *permutation matrix* (see [21]) if it has exactly one entry 1 in each row and each column and 0's elsewhere. Observe that if  $P \in M_n(\mathbb{S})$  is a permutation matrix, then  $PP^t = P^tP = I$ .

For each  $x \in \mathbb{F}$ , define

$$x^* = \begin{cases} 0, & \text{if } x = 0, \\ 1, & \text{if } x \neq 0. \end{cases}$$

Then the mapping

$$\varphi : \mathbb{F} \rightarrow \mathbb{B}_1, x \mapsto x^*$$

is a homomorphism. Its entrywise extension to a mapping

$$\psi : M_n(\mathbb{F}) \rightarrow M_n(\mathbb{B}_1), A \mapsto A^*$$

preserves sums, products and multiplication by scalars.

It is well known the only invertible matrices in  $M_n(\mathbb{B}_1)$  are permutation matrices (see [20]).

In fact, we can also obtain the following theorem.

**Theorem 2.1** *The permutation matrices are the only invertible matrices in  $M_n(\mathbb{F})$ .*

*Proof* Let  $A \in M_n(\mathbb{F})$  be an invertible matrix. Then there exists a matrix  $B \in M_n(\mathbb{F})$  such that  $AB = BA = I_n$ . This implies  $A^*B^* = B^*A^* = I_n$ , and thus  $A^*$  and  $B^*$  are permutation matrices with  $B^* = (A^*)^t$ . Notice that any product of two elements in  $\mathbb{F}$  is their minimum, the nonzero entries in  $A$  are 1's. Thus,  $A$  is a permutation matrix.  $\square$

Let  $E_{i,j} \in M_n(\mathbb{F})$  is the matrix with 1 as its  $(i,j)$ -entry and 0 elsewhere. We call such  $E_{i,j}$  a *cell* (see [19]) and denote  $\mathbb{E}_n = \{E_{i,j} | i, j \in \underline{n}\}$ , where  $\underline{n} = \{1, 2, \dots, n\}$ . By virtue of definition, for any  $E_{i,j}, E_{k,l} \in \mathbb{E}_n$ , we can easily have that

$$E_{i,j}E_{k,l} = \begin{cases} E_{i,l}, & \text{if } j = k, \\ O, & \text{otherwise.} \end{cases}$$

From [21], a semiring  $\mathbb{S}$  with 0 and 1 is said to be *commutative* if  $(S, \cdot, 1)$  is commutative; a semiring  $\mathbb{S}$  is called an *antiring* if  $a + b = 0$  implies  $a = b = 0$  for any  $a, b \in S$ , i.e., 0 is the unique invertible element in  $(S, +, 0)$ ; a semiring  $\mathbb{S}$  is said to be *entire* if  $a \neq 0, b \neq 0$  imply  $ab \neq 0$  for any  $a, b \in S$ . It is obvious that fuzzy semiring  $\mathbb{F}$  is a commutative entire antiring.

**Lemma 2.2**([16]) *Let  $\mathbb{S}$  be a commutative antiring and  $T$  a linear operator on  $M_n(\mathbb{S})$ . Then*

$T$  is invertible if and only if there exist a permutation  $\alpha$  on the set  $\{(i, j) | i, j \in \underline{n}\}$  and unit elements  $b_{ij} \in \mathbb{S}$ ,  $i, j \in \underline{n}$  such that  $T(E_{i,j}) = b_{ij}E_{\alpha(i,j)}$ .

Lemma 2.2 shows that if  $T$  is a linear operator on  $M_n(\mathbb{S})$  in which  $\mathbb{S}$  is a commutative antiring, then  $T$  permutes  $\mathbb{E}_n$  with unit scalar multiplication.

**Theorem 2.3** *Let  $\mathbb{F}$  be a fuzzy semiring. If  $T$  is a linear operator on  $M_n(\mathbb{F})$  with  $n = 1$ , then  $T$  preserves orthogonality of fuzzy matrices.*

*Proof* Let  $\mathbb{F}$  be a fuzzy semiring and  $T$  a linear operator on  $M_n(\mathbb{F})$  with  $n = 1$ . Suppose that  $A, B \in M_n(\mathbb{F})$  such that  $A$  and  $B$  are orthogonal. Then, we must have that  $A = O$  or  $B = O$ . It follows from the linearity of  $T$  that  $T(O) = O$ . Furthermore,  $T(A)T(B) = T(B)T(A) = O$ . Hence,  $T(A)$  and  $T(B)$  are orthogonal. So  $T$  preserves orthogonality of fuzzy matrices.  $\square$

**Theorem 2.4** *Let  $\mathbb{F}$  be a fuzzy semiring and  $T : M_n(\mathbb{F}) \rightarrow M_n(\mathbb{F})$  a linear operator with  $n \geq 2$ . Then  $T$  is an invertible linear operator that preserves orthogonality of fuzzy matrices if and only if there exists a permutation matrix  $P \in M_n(\mathbb{B}_1)$  such that either  $T(X) = PXP^t$  for all  $X \in M_n(\mathbb{F})$ , or  $T(X) = PX^tP^t$  for all  $X \in M_n(\mathbb{F})$ .*

*Proof* ( $\implies$ ) Let  $T$  be an invertible linear operator on  $M_n(\mathbb{F})$  which preserves orthogonality of fuzzy matrices. Note that fuzzy semiring  $\mathbb{F}$  is a commutative entire antiring, by the virtue of Lemma 2.2, there exists a permutation  $\alpha$  on the set  $\{(i, j) | i, j \in \underline{n}\}$  such that  $T(E_{i,j}) = E_{\alpha(i,j)}$ . For any  $i \neq j$ , denote  $T(E_{i,j}) = E_{p,q}$ . If  $p = q$  then it follows from  $E_{i,j}E_{i,j} = O$  that

$$(T(E_{i,j}))^2 = (E_{p,p})^2 = E_{p,p} = O,$$

it is a contradiction. Thus,  $p \neq q$ . Note that  $\alpha$  is a permutation, then there is a permutation  $\sigma$  of  $\{1, 2, \dots, n\}$  such that  $T(E_{i,i}) = E_{\sigma(i),\sigma(i)}$  for each  $i = 1, 2, \dots, n$ .

Define an operator  $L$  on  $M_n(\mathbb{F})$  by

$$L(X) = P^tT(X)P$$

for all  $X \in M_n(\mathbb{F})$ , where  $P$  is a permutation matrix corresponding to  $\sigma$  such that  $L(E_{i,i}) = E_{\sigma(i),\sigma(i)}$  for each  $i = 1, 2, \dots, n$ .

It is easy to see that  $L$  is an invertible linear operator on  $M_n(\mathbb{F})$  that preserves orthogonality of matrices. By Lemma 2.2,  $L$  permutes  $\mathbb{E}_n$ . Therefor, for any cell  $E_{r,s}$  in  $\mathbb{E}_n$ , there exists exactly one cell  $E_{p,q}$  in  $\mathbb{E}_n$  such that  $L(E_{r,s}) = E_{p,q}$ .

Suppose that  $r \neq s$ . Since  $L$  is injective, we have  $p \neq q$  because  $L(E_{i,i}) = E_{\sigma(i),\sigma(i)}$  for each  $i = 1, 2, \dots, n$ . Assume that  $p \neq r$  and  $p \neq s$ . Since  $E_{r,s}E_{p,p} = E_{p,p}E_{r,s} = O$ , we have

$$L(E_{p,p})L(E_{r,s}) = E_{p,p}E_{p,q} = E_{p,q} = O,$$

it is a contradiction. Hence,  $p = r$  or  $p = s$ . Similarly,  $q = r$  or  $q = s$ . Therefore, for each  $E_{r,s}$



in  $\mathbb{E}_n$ ,

$$L(E_{r,s}) = E_{r,s}, \text{ or } L(E_{r,s}) = E_{s,r}.$$

Suppose that  $L(E_{r,s}) = E_{r,s}$  for some  $E_{r,s} \in \mathbb{E}_n$  with  $r \neq s$  and  $L(E_{r,t}) = E_{t,r}$  for some  $t \in \underline{n}$  with  $t \neq r, s$ . It follows from  $E_{r,s}E_{r,t} = E_{r,t}E_{r,s} = O$  that

$$L(E_{r,t})L(E_{r,s}) = E_{t,r}E_{r,s} = E_{t,s} = O,$$

it is a contradiction. It follows that if  $L(E_{i,j}) = E_{i,j}$  for some  $E_{i,j} \in \mathbb{E}_n$  with  $i \neq j$ , then we have  $L(E_{r,s}) = E_{r,s}$  for all  $E_{r,s} \in \mathbb{E}_n$ .

Consequently, we have established that  $L(X) = X$  or  $L(X) = X^t$  for all  $X \in M_n(\mathbb{F})$ .

If  $L(X) = X$  for all  $X \in M_n(\mathbb{F})$ . By the definition of  $L$ , we have

$$P^t T(X) P = X,$$

or equivalently

$$T(X) = P X P^t$$

for all  $X \in M_n(\mathbb{F})$ .

Similarly, if  $L(X) = X^t$  for all  $X \in M_n(\mathbb{F})$ , we can get

$$T(X) = P X^t P^t.$$

( $\Leftarrow$ ) Suppose that  $T(X) = P X P^t$  for all  $X \in M_n(\mathbb{F})$ . It's a routine matter to verify that  $T$  is invertible. For any  $X, Y \in M_n(\mathbb{F})$ , if  $X$  and  $Y$  are orthogonal, then  $XY = YX = O$ . It follows that

$$T(X)T(Y) = T(Y)T(X) = O.$$

That is to say,  $T(X)$  and  $T(Y)$  are orthogonal. Thus,  $T$  preserves orthogonality of fuzzy matrices.

Similarly, if  $T(X) = P X^t P^t$  for all  $X \in M_n(\mathbb{F})$ , then  $T$  is also an invertible linear operator preserving orthogonality of fuzzy matrices.  $\square$

**Example 2.5** Let

$$P = \begin{bmatrix} 0 & 0 & 0 & 1 \\ 1 & 0 & 0 & 0 \\ 0 & 1 & 0 & 0 \\ 0 & 0 & 1 & 0 \end{bmatrix}$$

be a matrix in  $M_4(\mathbb{F})$ . Define an operator  $T$  on  $M_4(\mathbb{F})$  by

$$T(X) = P X^t P^t$$

for all  $X \in M_4(\mathbb{F})$ . By Theorem 2.4,  $T$  is an invertible linear operator preserving orthogonality of fuzzy matrices.

### §3. Linear Operators Preserving Orthogonality of Matrices Over the Direct Product of Fuzzy Semirings

In this section we will study the invertible linear operators that preserve orthogonality of matrices over the direct product of fuzzy semirings.

Hereafter, let  $\mathbb{S} = \prod_{\lambda \in \wedge} \mathbb{S}_\lambda$ , where  $\mathbb{S}_\lambda = \mathbb{F}$  is a fuzzy semiring for any  $\lambda \in \wedge$ . For any  $\lambda \in \wedge$  and any  $s \in \mathbb{S}$ , we denote  $s(\lambda)$  by  $s_\lambda$ . Define

$$(a + b)_\lambda = a_\lambda + b_\lambda, (ab)_\lambda = a_\lambda b_\lambda \quad (a, b \in \mathbb{S}, \lambda \in \wedge).$$

It is easy to verify that  $(\mathbb{S}, +, \cdot)$  is a semiring with 0 and 1 under the operations defined above. For any  $A = [a_{ij}] \in M_n(\mathbb{S})$  and any  $\lambda \in \wedge$ ,  $A_\lambda := [(a_{ij})_\lambda] \in M_n(\mathbb{S}_\lambda)$ . It is obvious that

$$(A + B)_\lambda = A_\lambda + B_\lambda, (AB)_\lambda = A_\lambda B_\lambda \text{ and } (sA)_\lambda = s_\lambda A_\lambda$$

for all  $A, B \in M_n(\mathbb{S})$  and all  $s \in \mathbb{S}$ .

By the above definition, it is not hard to obtain the following result.

**Lemma 3.1** *Let  $A, B \in M_n(\mathbb{S})$ . Then the following statements hold:*

- (i)  $A = B$  if and only if  $A_\lambda = B_\lambda$  for any  $\lambda \in \wedge$ ;
- (ii)  $A$  and  $B$  are orthogonal if and only if  $A_\lambda$  and  $B_\lambda$  are orthogonal for any  $\lambda \in \wedge$ .

The following lemma is due to Orel [14].

**Lemma 3.2** *If  $T : M_n(\mathbb{S}) \rightarrow M_n(\mathbb{S})$  is a linear operator, then for any  $\lambda \in \wedge$ , there exists a unique linear operator  $T_\lambda : M_n(\mathbb{S}_\lambda) \rightarrow M_n(\mathbb{S}_\lambda)$  such that  $(T(A))_\lambda = T_\lambda(A_\lambda)$  for any  $A \in M_n(\mathbb{S})$ .*

**Theorem 3.3** *Let  $\mathbb{S} = \prod_{\lambda \in \wedge} \mathbb{S}_\lambda$ , where  $\mathbb{S}_\lambda = \mathbb{F}$  is a fuzzy semiring for any  $\lambda \in \wedge$ . If  $T$  is a linear operator on  $M_n(\mathbb{S})$  with  $n = 1$ , then  $T$  preserves orthogonality of matrices.*

*Proof* Assume that  $A, B \in M_n(\mathbb{S})$ , and  $A$  and  $B$  are orthogonal. By Lemma 3.1 (ii), we have  $A_\lambda$  and  $B_\lambda$  are orthogonal for any  $\lambda \in \wedge$ . It follows from Theorem 2.3 that  $(T(A))_\lambda$  and  $(T(B))_\lambda$  are orthogonal. Again by Lemma 3.1 (ii), we obtain that  $T(A)$  and  $T(B)$  are orthogonal. Hence  $T$  preserves orthogonality of matrices.  $\square$

**Proposition 3.4** *Let  $T$  be a linear operator on  $M_n(\mathbb{S})$ . Then  $T$  is invertible if and only if  $T_\lambda$  is invertible for any  $\lambda \in \wedge$ .*

*Proof* ( $\implies$ ) Let  $T$  be a linear operator on  $M_n(\mathbb{S})$ . Suppose that  $T$  is invertible. For any  $\lambda \in \wedge$  and  $A, B \in M_n(\mathbb{S}_\lambda)$ , there exist  $X, Y \in M_n(\mathbb{S})$  such that  $X_\lambda = A, Y_\lambda = B$ , and  $X_\mu = Y_\mu = O$  for any  $\mu \neq \lambda$ . If  $T_\lambda(A) = T_\lambda(B)$  then

$$(T(X))_\lambda = T_\lambda(A) = T_\lambda(B) = (T(Y))_\lambda.$$

Also,

$$(T(X))_\mu = (T(Y))_\mu = T_\mu(O) = O$$

for any  $\mu \neq \lambda$ . This shows that  $T(X) = T(Y)$ . Since  $T$  is injective, we have  $X = Y$ . Further,

$$A = X_\lambda = Y_\lambda = B.$$

Thus  $T_\lambda$  is injective.

On the other hand, since  $T$  is surjective, there exists  $Q \in M_n(\mathbb{S})$  such that  $T(Q) = Y$ . We can deduce that

$$B = Y_\lambda = T(Q)_\lambda = T_\lambda(Q_\lambda).$$

That is to say,  $T_\lambda$  is surjective. Hence  $T_\lambda$  is invertible.

( $\Leftarrow$ ) Assume that  $T_\lambda$  is invertible for any  $\lambda \in \wedge$ . For any  $A, B \in M_n(\mathbb{S})$ , if  $T(A) = T(B)$  then

$$T_\lambda(A_\lambda) = (T(A))_\lambda = (T(B))_\lambda = T_\lambda(B_\lambda).$$

Since  $T_\lambda$  is injective, we have  $A_\lambda = B_\lambda$ . By Lemma 3.1 (i) it follows that  $A = B$ . So  $T$  is injective. Since  $T_\lambda$  is surjective, there exists  $X_\lambda$  such that  $T_\lambda(X_\lambda) = B_\lambda$ . Take  $A \in M_n(\mathbb{S})$  with  $A_\lambda = X_\lambda$  for any  $\lambda \in \wedge$ . It is clear that  $T(A) = B$ , and so  $T$  is surjective. Thus  $T$  is invertible.  $\square$

**Proposition 3.5** *Let  $T$  be a linear operator on  $M_n(\mathbb{S})$ . Then  $T$  preserves orthogonality of matrices if and only if  $T_\lambda$  preserves orthogonality of fuzzy matrices for any  $\lambda \in \wedge$ .*

*Proof* ( $\Rightarrow$ ) For any  $\lambda \in \wedge$  and any  $A, B \in M_n(\mathbb{F})$ , there exist  $X, Y \in M_n(\mathbb{S})$  such that  $X_\lambda = A, Y_\lambda = B$  and  $X_\mu = Y_\mu = O$  for any  $\mu \neq \lambda$ . If  $A$  and  $B$  are orthogonal, then  $XY = YX = O$ . Since  $T$  preserves orthogonality of matrices, we have  $T(X)T(Y) = T(Y)T(X) = O$ . Further,

$$T_\lambda(A)T_\lambda(B) = (T(X))_\lambda(T(Y))_\lambda = ((T(X)T(Y))_\lambda) = O.$$

Similarly,  $T_\lambda(B)T_\lambda(A) = O$ . This shows that  $T_\lambda(A)$  and  $T_\lambda(B)$  are orthogonal. So  $T_\lambda$  preserves orthogonality of fuzzy matrices as required.

( $\Leftarrow$ ) For any  $X, Y \in M_n(\mathbb{S})$ , if  $X$  and  $Y$  are orthogonal, then  $X_\lambda$  and  $Y_\lambda$  are orthogonal for any  $\lambda \in \wedge$  by Lemma 3.1 (i). Since  $T_\lambda$  preserves orthogonality of fuzzy matrices, we have

$$(T(X))_\lambda(T(Y))_\lambda = T_\lambda(X_\lambda)T_\lambda(Y_\lambda) = O.$$

Similarly,  $(T(Y))_\lambda(T(X))_\lambda = O$ . So  $T(X)_\lambda$  and  $T(Y)_\lambda$  are orthogonal. Again by Lemma 3.1 (ii), we can show that  $T(X)$  and  $T(Y)$  are orthogonal. Therefore,  $T$  preserves orthogonality of matrices.  $\square$

In the following, we will give the main theorem of this section.

**Theorem 3.6** *Let  $\mathbb{S} = \prod_{\lambda \in \wedge} \mathbb{S}_\lambda$ , where  $\mathbb{S}_\lambda = \mathbb{F}$  is a fuzzy semiring for any  $\lambda \in \wedge$ . Let  $T : M_n(\mathbb{S}) \rightarrow M_n(\mathbb{S})$  be a linear operator with  $n \geq 2$ . Then  $T$  is an invertible linear operator preserving orthogonality of matrices if and only if there exist  $P \in M_n(\mathbb{S})$  and  $s_1, s_2 \in \mathbb{S}$  such that*

$$T(X) = P(s_1X + s_2X^t)P^t$$

for all  $X \in M_n(\mathbb{S})$ , where  $(s_1)_\lambda, (s_2)_\lambda \in \{0, 1\}$ ,  $(s_1)_\lambda \neq (s_2)_\lambda$  and  $P_\lambda \in M_n(\mathbb{F})$  is a permutation matrix for any  $\lambda \in \wedge$ .

*Proof* ( $\implies$ ) It follows from Propositions 3.4 and 3.5 that  $T_\lambda$  is an invertible linear operator preserving orthogonality of matrices. For any  $X \in M_n(\mathbb{S})$ ,  $X_\lambda \in M_n(\mathbb{F})$ . By virtue of Theorem 2.4, there exists permutation matrix  $P_\lambda \in M_n(\mathbb{F})$  such that either

$$T_\lambda(X_\lambda) = P_\lambda X_\lambda P_\lambda^t \quad (1)$$

for all  $X_\lambda \in M_n(\mathbb{S}_\lambda)$ , or

$$T_\lambda(X_\lambda) = P_\lambda X_\lambda^t P_\lambda^t \quad (2)$$

for all  $X_\lambda \in M_n(\mathbb{S}_\lambda)$ . Let  $\wedge_1 := \{\lambda \in \wedge \mid T_\lambda \text{ is the form of (1)}\}$  and  $\wedge_2 := \{\lambda \in \wedge \mid T_\lambda \text{ is the form of (2)}\}$ . It is clear that  $\wedge_1 \cap \wedge_2 = \emptyset$ ,  $\wedge_1 \cup \wedge_2 = \wedge$ . For  $i = 1, 2$ , let  $s_i \in \mathbb{S}$ , where  $(s_i)_\lambda = 1$  if  $\lambda \in \wedge_i$  and 0 otherwise. Thus, for any  $X \in M_n(\mathbb{S})$ , there exist  $P \in M_n(\mathbb{S})$  and  $s_1, s_2 \in \mathbb{S}$  such that

$$T(X) = P(s_1 X + s_2 X^t) P^t,$$

where  $(s_1)_\lambda, (s_2)_\lambda \in \{0, 1\}$ ,  $(s_1)_\lambda \neq (s_2)_\lambda$  and  $P_\lambda \in M_n(\mathbb{F})$  is a permutation matrix for any  $\lambda \in \wedge$ .

( $\impliedby$ ) For any  $\lambda \in \wedge$  and any  $A \in M_n(\mathbb{S}_\lambda)$ , there exists  $X \in M_n(\mathbb{S})$  such that  $A = X_\lambda$ . We have

$$T_\lambda(A) = T_\lambda(X_\lambda) = (T(X))_\lambda = (P(s_1 X + s_2 X^t) P^t)_\lambda.$$

If  $(s_1)_\lambda = 1, (s_2)_\lambda = 0$ , then  $T_\lambda(A) = P_\lambda A P_\lambda^t$  for any  $A \in M_n(\mathbb{S}_\lambda)$ . Otherwise,  $T_\lambda(A) = P_\lambda A^t P_\lambda^t$  for any  $A \in M_n(\mathbb{S}_\lambda)$ . It follows from Theorem 2.4 that  $T_\lambda$  is an invertible linear operator preserving orthogonality. Hence  $T$  is an invertible linear operator preserving orthogonality of matrices by Propositions 3.4 and 3.5.  $\square$

Thus we have obtained complete characterizations of invertible linear operators preserving orthogonality of matrices over the direct product of fuzzy semirings by Theorems 3.3 and 3.6.

**Example 3.7** Let  $\mathbb{S} = \mathbb{F} \times \mathbb{F} \times \mathbb{F}$ . Take

$$P = \begin{bmatrix} (0, 1, 1) & (1, 0, 0) & (0, 0, 0) \\ (1, 0, 0) & (0, 1, 0) & (0, 0, 1) \\ (0, 0, 0) & (0, 0, 1) & (1, 1, 0) \end{bmatrix} \in M_3(\mathbb{S})$$

and  $s_1 = (0, 1, 0), s_2 = (1, 0, 1)$  in  $\mathbb{S}$ . Define an operator on  $M_3(\mathbb{S})$  by

$$T(X) = P(s_1 X + s_2 X^t) P^t$$

for all  $X \in M_3(\mathbb{S})$ .

It is obvious that  $P_\lambda (\lambda = 1, 2, 3)$  are all permutation matrices. Thus, by Theorem 3.6,  $T$  is an invertible linear operator that preserves orthogonality of matrices over  $\mathbb{S}$ .

## References

- [1] L.B. Beasley, A.E. Guterman, Y.B. Jun, S.Z. Song, Linear preservers of extremes of rank inequalities over semirings: Row and column ranks, *Linear Algebra Appl.*, 413 (2006), 495-509.
- [2] L.B. Beasley, S.G. Lee, Linear operators that strongly preserve  $r$ -potent matrices over semirings, *Linear Algebra Appl.*, 162-164 (1992), 589-599.
- [3] M. Burgos, F.J. Fernández-Polo, J.J. Garcés, J. Martínez Moreno, A.M. Peralta, Orthogonality preservers in  $C^*$ -algebras,  $JB^*$ -algebra and  $JB^*$ -triples, *J. Math. Anal. Appl.*, 348 (2008), 220-233.
- [4] J. Chmieliński, Linear mappings approximately preserving orthogonality, *J. Math. Anal. Appl.*, 304 (2005), 158-169.
- [5] J.L. Cui, J.C. Hou, C.G. Park, Indefinite orthogonality preserving additive maps, *Arch. Math.*, 83 (2004), 548-557.
- [6] D. Dolžan, P. Oblak, Idempotent matrices over antirings, *Linear Algebra Appl.*, 431 (5-7) (2009), 823-832.
- [7] A. Guterman, C.K. Li, P. Šemrl, Some general techniques on linear preserver problems, *Linear Algebra Appl.*, 315 (2000), 61-81.
- [8] J.S. Golan, *Semirings and Their Applications*, Kluwer, Dordrecht, 1999.
- [9] D. Ilišević, A. Turnšek, Approximately orthogonality preserving mappings on  $C^*$ -modules, *J. Math. Anal. Appl.*, 341 (2008), 298-308.
- [10] K.T. Kang, S.Z. Song, Y.B. Jun, Linear operators that strongly preserves regularity of fuzzy matrices, *Math. Commun.*, 15 (1) (2010), 243-254.
- [11] S. Kirkland, N.J. Pullman, Linear operators preserving invariants of nonbinary Boolean matrices, *Linear Multilinear Algebra*, 33 (3-4) (1993), 295-300.
- [12] H.H. Li, Y.J. Tan, Linear operators that strongly preserves nilpotent matrices over antinegative semirings, *Northeast. Math. J.*, 23 (1) (2007), 71-86.
- [13] B. Mojskerc, A. Turnšek, Mappings approximately preserving orthogonality in normed spaces, *Nonlinear Anal.*, 73 (2010), 3821-3831.
- [14] M. Orel, Nonbijective idempotents preservers over semirings, *J. Korean Math. Soc.*, 47 (4) (2010), 805-818.
- [15] O.A. Pshenitsyna, Maps preserving invertibility of matrices over semirings, *Russ. Math. Surv.*, 64 (1) (2009), 62-164.
- [16] S.Z. Song, K.T. Kang, L.B. Beasley, Idempotent matrix preservers over Boolean algebras, *J. Korean Math. Soc.*, 44 (1) (2007), 169-178.
- [17] P. Šemrl, Maps on matrix spaces, *Linear Algebra Appl.*, 413 (2006), 364-393.
- [18] P. Šemrl, Maps on idempotent matrices over division rings, *J. Algebra*, 298 (2006), 142-187.
- [19] S.Z. Song, K.T. Kang, Y.B. Jun, Linear preservers of Boolean nilpotent matrices, *J. Korean Math. Soc.*, 43 (3) (2006), 539-552.
- [20] S.Z. Song, K.T. Kang, Linear maps that preserve commuting pairs of matrices over general Boolean algebra, *J. Korean Math. Soc.*, 43 (1) (2006), 77-86.
- [21] S.Z. Song, K.T. Kang, L.B. Beasley, N.S. Sze, Regular matrices and their strong preservers over semirings, *Linear Algebra Appl.*, 429 (2008), 209-223.

## On Wiener and Weighted Wiener Indices of Neighborhood Corona of Two Graphs

Chandrashekar Adiga<sup>1</sup>, Rakshith B. R.<sup>1</sup>, Sumithra<sup>2</sup> and N. Anitha<sup>3</sup>

1.Department of Studies in Mathematics, University of Mysore, Manasagangothri, Mysuru - 570006, India

2.Department of Mathematics, NIE Institute of Technology, Mysuru-570018, India

3.Department of Mathematics, PES University, Bangalore-560085, India

E-mail: c\_adiga@hotmail.com, ranmsc08@yahoo.co.in, sumithra.aravind@gmail.com, nanitha@pes.edu.in

**Abstract:** In this paper, we compute the Wiener index, degree distance index and Gutman index of neighborhood corona of two graphs.

**Key Words:** Neighborhood corona, Wiener index, degree distance index, Gutman index.

**AMS(2010):** 05C12, 05C07, 05C76

### §1. Introduction

Let  $G = (V, E)$  be a connected simple graph. The distance between two vertices  $u$  and  $v$  in  $G$ , denoted by  $d_G(u, v)$  is the length of a shortest path between  $u$  and  $v$  in  $G$ . The degree of a vertex  $u$  in  $G$ , denoted by  $d_G(u)$  is the number of vertices that are adjacent to  $u$  in  $G$ . The Wiener index  $W(G)$  of a graph  $G$  is a distance based graph invariant introduced by H. Wiener [18] in order to determine the boiling point of paraffin. It is defined as the sum of distance between all pairs of vertices in  $G$ . i.e.,  $W(G) = \sum_{\{u,v\} \subseteq V(G)} d_G(u, v)$ . The degree distance index  $DD(G)$  and Gutman index  $Gut(G)$  of a graph are weighted versions of Wiener index, which are defined as follows:

$$DD(G) = \sum_{\{u,v\} \subseteq V(G)} (d_G(u) + d_G(v))d_G(u, v)$$

and

$$Gut(G) = \sum_{\{u,v\} \subseteq V(G)} d_G(u) d_G(v) d_G(u, v).$$

The degree distance index which is a degree distance based graph invariant, was introduced independently by A. A. Dobrynin, A. A. Kochetova [6] and I. Gutman [10]. The Gutman index, earlier known as Schultz index of the second kind was introduced in 1994 by Gutman [10]. It may be noted that if  $G$  is a tree on  $n$  vertices, then the Wiener index, degree distance index and Gutman index are closely related by the identities  $DD(G) = 4W(G) - n(n - 1)$  and

---

<sup>1</sup>Received December 9, 2015, Accepted November 15, 2016.

$Gut(G) = 4W(G) - (2n - 1)(n - 1)$ . More details about Wiener index and its variants can be found in [2, 3, 4, 5, 6, 7, 12, 14, 17] and the references cited therein.

The corona [9] of two graphs  $G_1$  and  $G_2$  is the graph obtained by taking one copy of  $G_1$ ,  $|V(G_1)|$  copies of  $G_2$  and joining each  $i$ -th vertex of  $G_1$  to every vertex in the  $i$ -th copy of  $G_2$ . The neighborhood corona [13] of two graphs  $G_1$  and  $G_2$  denoted by  $G_1 * G_2$ , is a variant of corona of two graphs and is defined as the graph obtained by taking one copy of  $G_1$  and  $|V(G_1)|$  copies of  $G_2$ , and joining every neighbour of the  $i$ -th vertex of  $G_1$  to every vertex in the  $i$ -th copy of  $G_2$ . Recently, various graph invariants of corona product of two graphs have been studied, for example, see [1, 15, 19].

**Example 1.1** The neighborhood corona  $P_3 * P_2$ .

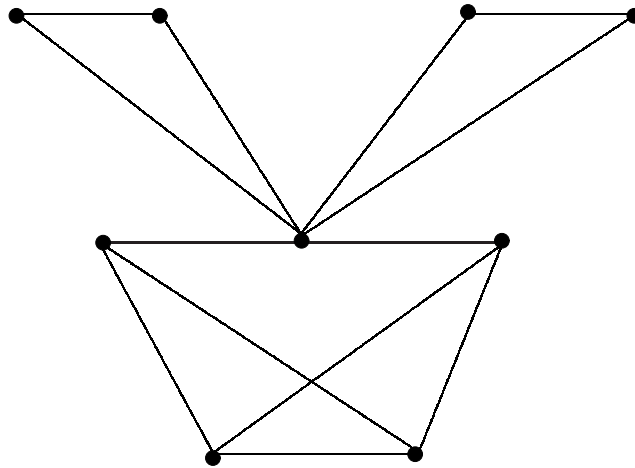

Fig. 1.  $P_3 * P_2$ .

In this paper, we compute Wiener index, degree distance index and Gutman index of  $G_1 * G_2$ .

## §2. Main Results

Let  $G_1$  be a graph with vertex set  $V(G_1) = \{v_1, v_2, \dots, v_{n_1}\}$ , edge  $E(G_1) = \{e_1, e_2, \dots, e_{m_1}\}$  and let  $G_2$  be a graph with vertex set  $V(G_2) = \{u_1, u_2, \dots, u_{n_2}\}$  and edge set  $E(G_2) = \{e'_1, e'_2, \dots, e'_{m_2}\}$ . We denote the vertex set of the  $i$ -th copy of  $G_2$  by  $V_i(G_2) = \{u_{i1}, u_{i2}, \dots, u_{in_2}\}$ .

To prove our main results we need the following definitions and two lemmas whose proofs follows directly by the definition of neighborhood corona.

**Definition 2.1** For a graph  $G$ , we define

$$E_{\Delta}(G) := \{e \in E(G) : e \text{ is contained in a triangle of } G\},$$

$$T_1(G) := \sum_{uv \in E_{\Delta}(G)} d(u) + d(v) \text{ and } T_2(G) := \sum_{uv \in E_{\Delta}(G)} d(u)d(v).$$

Clearly, if  $G$  has a vertex  $v$  of degree of  $|V(G)| - 1$  and  $G - v$  is connected graph with at least two vertices, then  $E_{\Delta}(G) = E(G)$ ,  $T_1(G) = M_1(G)$  and  $T_2(G) = M_2(G)$ .

**Lemma 2.2** Let  $G = G_1 * G_2$ . Then

$$d_G(x) = \begin{cases} (n_2 + 1)d_{G_1}(x), & \text{if } x \in V(G_1), \\ d_{G_2}(x) + d_{G_1}(v_i), & \text{if } x \in V_i(G_2). \end{cases}$$

**Lemma 2.3** If  $G = G_1 * G_2$ , then

- (1)  $d_G(v_i, v_j) = d_{G_1}(v_i, v_j), \forall v_i, v_j \in V(G_1)$ ;
- (2)  $d_G(u_{ij}, u_{ik}) = \begin{cases} 1, & \text{if } u_j u_k \in E(G_2), \\ 2, & \text{if } u_j u_k \notin E(G_2). \end{cases}$  ;
- (3) for  $i \neq k$ ,  $d_G(u_{ij}, u_{km}) = \begin{cases} 3, & \text{if } v_i v_k \in E(G_1) \text{ and } v_i v_k \notin E_{\Delta}(G_1), \\ 2, & \text{if } v_i v_k \in E_{\Delta}(G_1), \\ d_{G_1}(v_i, v_k), & \text{if } v_i v_k \notin E(G_1). \end{cases}$  ;
- (4)  $d_G(u_{ij}, v_k) = \begin{cases} d_{G_1}(v_i, v_k), & \text{if } v_i \neq v_k, \\ 2, & \text{if } v_i = v_k. \end{cases}$  .

**Theorem 2.4** The Wiener index of  $G = G_1 * G_2$  is given by

$$W(G) = (n_2 + 1)^2 W(G_1) + n_1(n_2(n_2 - 1) - m_2) + n_2^2(2m_1 - |E_{\Delta}(G_1)|) + 2n_1n_2.$$

*Proof* We know that

$$W(G) = \sum_{\{x, y\} \subseteq V(G)} d_G(x, y) = A_1 + A_2 + A_3 + A_4, \tag{2.1}$$



where

$$\begin{aligned} A_1 &= \sum_{\{v_i, v_j\} \subseteq V(G_1)} d_G(v_i, v_j), \\ A_2 &= \sum_{v_i \in V(G_1)} \sum_{\{u_{ij}, u_{ik}\} \subseteq V_i(G_2)} d_G(u_{ij}, u_{ik}), \\ A_3 &= \sum_{\{v_i, v_j\} \subseteq V(G_1)} \sum_{\substack{u_{ik} \in V_i(G_2) \\ u_{jm} \in V_j(G_2)}} d_G(u_{ik}, u_{jm}) \end{aligned}$$

and

$$A_4 = \sum_{v_i \in V(G_1)} \sum_{\substack{u_{ij} \in V_i(G_2) \\ v_k \in V(G_1)}} d_G(u_{ij}, v_k).$$

By Lemma 2.3, we have

$$A_1 = \sum_{\{v_i, v_j\} \subseteq V(G_1)} d_G(v_i, v_j) = \sum_{\{v_i, v_j\} \subseteq V(G_1)} d_{G_1}(v_i, v_j) = W(G_1), \quad (2.2)$$

$$\begin{aligned} A_2 &= \sum_{v_i \in V(G_1)} \sum_{\{u_{ij}, u_{ik}\} \subseteq V_i(G_2)} d_G(u_{ij}, u_{ik}) \\ &= \sum_{v_i \in V(G_1)} \left\{ \sum_{\{u_{ij}, u_{ik}\} \subseteq V_i(G_2)} 2 - \sum_{u_j u_k \in E(G_2)} 1 \right\} \\ &= \sum_{v_i \in V(G_1)} (n_2(n_2 - 1) - m_2) = n_1(n_2(n_2 - 1) - m_2), \end{aligned} \quad (2.3)$$

$$\begin{aligned} A_3 &= \sum_{\{v_i, v_j\} \subseteq V(G_1)} \sum_{\substack{u_{ik} \in V_i(G_2) \\ u_{jm} \in V_j(G_2)}} d_G(u_{ik}, u_{jm}) \\ &= n_2^2 \left\{ \sum_{\{v_i, v_j\} \subseteq V(G_1)} d_{G_1}(v_i, v_j) + \sum_{v_i v_j \in E(G_1)} 2 - \sum_{v_i v_j \in E_\Delta(G_1)} 1 \right\} \\ &= n_2^2(W(G_1) + 2m_1 - |E_\Delta(G_1)|) \end{aligned} \quad (2.4)$$

and

$$\begin{aligned} A_4 &= \sum_{v_i \in V(G_1)} \left\{ \sum_{\substack{u_{ij} \in V_i(G_2) \\ v_k \in V(G_1) \\ v_k \neq v_i}} d_G(v_k, u_{ij}) + \sum_{u_{ij} \in V_i(G_2)} 2 \right\} \\ &= n_2 \sum_{v_i \in V(G_1)} \sum_{v_k \in V(G_1)} d_{G_1}(v_i, v_k) + 2n_1 n_2 \\ &= 2n_2 W(G_1) + 2n_1 n_2. \end{aligned} \quad (2.5)$$

Applying (2.2), (2.3), (2.4) and (2.5) in (2.1), we obtain the desired result.  $\square$

**Corollary 2.5** *If  $G_1$  is a triangle free graph, then the Wiener index of  $G = G_1 * G_2$  is given by*

$$W(G) = (n_2 + 1)^2 W(G_1) + n_1(n_2(n_2 - 1) - m_2) + 2n_2^2 m_1 + 2n_1 n_2.$$

**Corollary 2.6** *If  $G_1 = H_1 \vee H_2$  (join of two connected graphs  $H_1$  and  $H_2$  with  $|V(H_1)| \geq 2$ ), then the Wiener index of  $G = G_1 * G_2$  is given by*

$$W(G) = (n_2 + 1)^2 W(G_1) + n_1(n_2(n_2 - 1) - m_2) + n_2^2 m_1 + 2n_1 n_2.$$

**Lemma 2.7**([4]) *Let  $P_n$  and  $C_n$  denote the path and cycle on  $n$  vertices, respectively. Then*

$$W(P_n) = \frac{n(n^2 - 1)}{6}$$

and

$$W(C_n) = \begin{cases} n^3/8, & \text{if } n \text{ is even,} \\ n(n^2 - 1)/8, & \text{if } n \text{ is odd.} \end{cases}$$

Applying the above lemma in Theorem 2.4, we obtain the following corollary.

**Corollary 2.8** (1)  $W(P_n * P_m) = \frac{1}{6}((m + 1)^2 n^3 + (17m^2 - 2m + 5)n) - 2m^2$ ;  
 (2)  $W(C_{2n} * C_m) = ((m + 1)^2 n^2 + 6m^2)n$ ;  
 (3) For  $n \neq 1$ ,  $W(C_{2n+1} * C_m) = (2n + 1)(m^2 n^2 + m^2 n + 2mn^2 + 6m^2 + 2mn + n^2 + n)/2$ ;  
 (4) For  $n \neq 1$ ,  $W(C_{2n+1} * P_m) = (2n + 1)(m^2 n^2 + m^2 n + 2mn^2 + 6m^2 + 2mn + n^2 + n + 2)/2$ ;  
 (5)  $W(C_{2n} * P_m) = m^2 n^3 + 2mn^3 + 6m^2 n + n^3 + 2n$ ;  
 (6)  $W(P_n * C_m) = \frac{1}{6}((m + 1)^2 n^3 + (17m^2 - 2m - 1)n) - 2m^2$ .

The first and second Zagreb indices of a graph denoted by  $M_1(G)$  and  $M_2(G)$ , respectively, are degree based topological indices introduced by Gutman and N. Trinajstić ([11]). These two indices are defined as

$$M_1(G) = \sum_{e_i=v_l v_m \in E(G)} d_G(v_l) + d_G(v_m) = \sum_{v_i \in G} d_G^2(v_i)$$

and

$$M_2(G) = \sum_{e_i=v_l v_m \in E(G)} d_G(v_l) d_G(v_m).$$

Now, we derive a formula for  $DD(G_1 * G_2)$  in terms of degree distance of  $G_1$ , Wiener index of  $G_1$  and first Zagreb index of  $G_1$  and  $G_2$ .

**Theorem 2.9** *The degree distance index of  $G = G_1 * G_2$  is given by*

$$DD(G) = (2n_2^2 + 3n_2 + 1)DD(G_1) + 4m_2(n_2 + 1)W(G_1) + n_2^2(2M_1(G_1) - T_1(G_1)) \\ - n_1M_1(G_2) + (8n_2^2 + (8m_2 + 4)n_2 - 4m_2)m_1 + 4m_2n_2(n_1 - |E_\Delta(G_1)|).$$

*Proof* We know that

$$DD(G) = \sum_{\{x,y\} \subseteq V(G)} (d_G(x) + d_G(y)) d_G(x, y) = A_1 + A_2 + A_3 + A_4, \quad (2.6)$$

where

$$A_1 = \sum_{\{v_i, v_j\} \subseteq V(G_1)} (d_G(v_i) + d_G(v_j)) d_G(v_i, v_j), \\ A_2 = \sum_{v_i \in V(G_1)} \sum_{\{u_{ij}, u_{ik}\} \subseteq V_i(G_2)} [d_G(u_{ij}) + d_G(u_{ik})] d_G(u_{ij}, u_{ik}), \\ A_3 = \sum_{\{v_i, v_j\} \subseteq V(G_1)} \sum_{\substack{u_{ik} \in V_i(G_2) \\ u_{jm} \in V_j(G_2)}} [d_G(u_{ik}) + d_G(u_{jm})] d_G(u_{ik}, u_{jm})$$

and 
$$A_4 = \sum_{v_i \in V(G_1)} \sum_{\substack{u_{ij} \in V_i(G_2) \\ v_k \in V(G_1)}} [d_G(u_{ij}) + d_G(v_k)] d_G(u_{ij}, v_k).$$

Applying Lemmas 2.2 and 2.3, we compute  $A_1, A_2, A_3$  and  $A_4$  as follows:

$$A_1 = \sum_{\{v_i, v_j\} \subseteq V(G_1)} (d_G(v_i) + d_G(v_j)) d_G(v_i, v_j) \\ = (n_2 + 1) \sum_{\{v_i, v_j\} \subseteq V(G_1)} (d_{G_1}(v_i) + d_{G_1}(v_j)) d_{G_1}(v_i, v_j) \\ = (n_2 + 1)DD(G_1). \quad (2.7)$$

$$A_2 = \sum_{v_i \in V(G_1)} \sum_{\{u_{ij}, u_{ik}\} \subseteq V_i(G_2)} [d_G(u_{ij}) + d_G(u_{ik})] d_G(u_{ij}, u_{ik}) \\ = \sum_{v_i \in V(G_1)} \left\{ 2 \sum_{\{u_{ij}, u_{ik}\} \subseteq V_i(G_2)} [2d_{G_1}(v_i) + d_{G_2}(u_j) + d_{G_2}(u_k)] \right. \\ \left. - \sum_{u_j u_k \in E(G_2)} [2d_G(v_i) + d_{G_2}(u_j) + d_{G_2}(u_k)] \right\} \\ = \sum_{v_i \in V(G_1)} \{2(n_2(n_2 - 1)d_{G_1}(v_i) + 2(n_2 - 1)m_2) - 2m_2d_G(v_i) - M_1(G_2)\} \\ = 4(n_2(n_2 - 1) - m_2)m_1 + 4n_1m_2(n_2 - 1) - n_1M_1(G_2). \quad (2.8)$$

$$\begin{aligned}
 A_3 &= \sum_{\{v_i, v_j\} \subseteq V(G_1)} \sum_{\substack{u_{ik} \in V_i(G_2) \\ u_{jm} \in V_j(G_2)}} [d_G(u_{ik}) + d_G(u_{jm})] d_G(u_{ik}, u_{jm}) \\
 &= \sum_{\{v_i, v_j\} \subseteq V(G_1)} d_{G_1}(v_i, v_j) \sum_{\substack{u_{ik} \in V_i(G_2) \\ u_{jm} \in V_j(G_2)}} [d_{G_1}(v_i) + d_{G_1}(v_j) + d_{G_2}(u_{ik}) + d_{G_2}(u_{jm})] \\
 &+ 2 \sum_{v_i v_j \in E(G_1)} \sum_{\substack{u_{ik} \in V_i(G_2) \\ u_{jm} \in V_j(G_2)}} [d_{G_1}(v_i) + d_{G_1}(v_j) + d_{G_2}(u_{ik}) + d_{G_2}(u_{jm})] \\
 &- \sum_{v_i v_j \in E_\Delta(G_1)} \sum_{\substack{u_{ik} \in V_i(G_2) \\ u_{jm} \in V_j(G_2)}} [d_{G_1}(v_i) + d_{G_1}(v_j) + d_{G_2}(u_{ik}) + d_{G_2}(u_{jm})] \\
 &= \sum_{\{v_i, v_j\} \subseteq V(G_1)} d_{G_1}(v_i, v_j) [n_2^2(d_{G_1}(v_i) + d_{G_1}(v_j)) + 4n_2m_2] \\
 &+ 2 \sum_{v_i v_j \in E(G_1)} [n_2^2(d_{G_1}(v_i) + d_{G_1}(v_j)) + 4n_2m_2] \\
 &- \sum_{v_i v_j \in E_\Delta(G_1)} [n_2^2(d_{G_1}(v_i) + d_{G_1}(v_j)) + 4n_2m_2] \\
 &= n_2^2 DD(G_1) + 4n_2m_2 W(G_1) + n_2^2(2M_1(G_1) - T_1(G_1)) + 4n_2m_2(2m_1 - |E_\Delta(G_1)|). \tag{2.9}
 \end{aligned}$$

$$\begin{aligned}
 A_4 &= \sum_{v_i \in V(G_1)} \sum_{\substack{u_{ij} \in V_i(G_2) \\ v_k \in V(G_1)}} [d_G(u_{ij}) + d_G(v_k)] d_G(u_{ij}, v_k) \\
 &= \sum_{v_i \in V(G_1)} \left\{ \sum_{\substack{u_{ij} \in V_i(G_2) \\ v_k \in V(G_1) \\ v_i \neq v_k}} [d_G(u_{ij}) + d_G(v_k)] d_G(u_{ij}, v_k) + 2 \sum_{u_{ij} \in V_i(G_2)} (d_G(u_{ij}) + d_G(v_i)) \right\} \\
 &= \sum_{v_i \in V(G_1)} \left\{ \sum_{v_k \in V(G_1)} (n_2 d_{G_1}(v_i) + n_2(n_2 + 1) d_{G_1}(v_k) + 2m_2) d_{G_1}(v_i, v_k) + 2[2m_2 + n_2(n_2 + 2)] d_G(v_i) \right\} \\
 &= (n_2^2 + 2n_2) DD(G_1) + 4m_2 W(G_1) + 4n_1 m_2 + 4m_1(n_2 + 2)n_2. \tag{2.10}
 \end{aligned}$$

Applying (2.7), (2.8), (2.9) and (2.10) in (2.6), we obtain the desired result. □

**Corollary 2.10** *If  $G_1$  is a triangle free graph, then the degree distance index of  $G = G_1 * G_2$  is given by*

$$\begin{aligned}
 DD(G) &= (2n_2^2 + 3n_2 + 1)DD(G_1) + 4m_2(n_2 + 1)W(G_1) + 2n_2^2M_1(G_1) \\
 &- n_1M_1(G_2) + (8n_2^2 + (8m_2 + 4)n_2 - 4m_2)m_1 + 4m_2n_2n_1.
 \end{aligned}$$

**Corollary 2.11** *If  $G_1 = H_1 \vee H_2$  (join of two connected graphs  $H_1$  and  $H_2$  with  $|V(H_1)| \geq 2$ ),*

then the degree distance index of  $G = G_1 * G_2$  is given by

$$DD(G) = (2n_2^2 + 3n_2 + 1)DD(G_1) + 4m_2(n_2 + 1)W(G_1) + n_2^2M_1(G_1) \\ - n_1M_1(G_2) + (2n_2^2 + (m_2 + 1)n_2 - m_2)4m_1 + 4m_2n_2n_1.$$

**Lemma 2.12**([7,16]) *Let  $P_n$  and  $C_n$  denote the path and cycle on  $n$  vertices, respectively. Then*

$$DD(P_n) = \frac{n(n-1)(2n-1)}{3}$$

and

$$DD(C_n) = \begin{cases} n^3/2, & \text{if } n \text{ is even,} \\ n(n^2-1)/2, & \text{if } n \text{ is odd.} \end{cases}$$

Using Lemmas 2.7, 2.12 and also the facts that  $M_1(P_n) = 4n - 6$  ( $n \geq 2$ ),  $M_2(P_n) = 4n - 8$  ( $n \geq 3$ ),  $M_1(C_n) = M_2(C_n) = 4n$  in Theorem 2.9, we obtain the following corollary.

**Corollary 2.13** (1)  $DD(P_n * P_m) = (2n^3 - 2n^2 + 28n - 28)m^2 + (2n^3 - 3n^2 - 15n + 8)m - n^2 + 11n - 4$ ;

(2)  $DD(C_{2n} * C_m) = 4n(3m^2n^2 + 4mn^2 + 14m^2 + n^2 - 2m)$ ;

(3) for  $n \neq 1$ ,  $DD(C_{2n+1} * C_m) = 2(2n+1)(3m^2n^2 + 3m^2n + 4mn^2 + 14m^2 + 4mn + n^2 - 2m + n)$ ;

(4) for  $n \neq 1$ ,  $DD(C_{2n+1} * P_m) = 2(2n+1)(3m^2n^2 + 3m^2n + 3mn^2 + 14m^2 + 3mn - 8m + 5)$ ;

(5)  $DD(C_{2n} * P_m) = 4n(3m^2n^2 + 3mn^2 + 14m^2 - 8m + 5)$ ;

(6)  $DD(P_n * C_m) = \frac{1}{3}((6m^2 + 8m + 2)n^3 - (6m^2 + 9m + 3)n^2 + (84m^2 - 11m + 1)n) - 28m^2$ .

Now, we derive a formula for  $Gut(G_1 * G_2)$  in terms of degree distance of  $G_1$ , Gutman index of  $G_1$ , Wiener index of  $G_1$  and Zagreb indices of  $G_1$  and  $G_2$ .

**Theorem 2.14** *The Gutman index of  $G = G_1 * G_2$  is given by*

$$Gut(G) = (2n_2 + 1)^2Gut(G_1) + 2m_2(2n_2 + 1)DD(G_1) + 4m_2^2W(G_1) - (n_1 + 2m_1)M_1(G_2) \\ - n_1M_2(G_2) + (n_2(3n_2 + 4m_2 + 1) - m_2)M_1(G_1) + n_2^2(2M_2(G_1) - T_2(G_1)) \\ - 2n_2m_2T_1(G_1) - 4m_2^2|E_{\Delta}(G_1)| + 8m_1m_2[2n_2 + m_2] + 4n_1m_2^2.$$

*Proof* Notice that

$$Gut(G) = \sum_{\{x,y\} \subseteq V(G)} (d_G(x) d_G(y)) d_G(x, y) = A_1 + A_2 + A_3 + A_4, \quad (2.11)$$

where

$$\begin{aligned}
 A_1 &= \sum_{\{v_i, v_j\} \subseteq V(G_1)} d_G(v_i) d_G(v_j) d_G(v_i, v_j), \\
 A_2 &= \sum_{v_i \in V(G_1)} \sum_{\{u_{ij}, u_{ik}\} \subseteq V_i(G_2)} d_G(u_{ij}) d_G(u_{ik}) d_G(u_{ij}, u_{ik}), \\
 A_3 &= \sum_{\{v_i, v_j\} \subseteq V(G_1)} \sum_{\substack{u_{ik} \in V_i(G_2) \\ u_{jm} \in V_j(G_2)}} d_G(u_{ik}) d_G(u_{jm}) d_G(u_{ik}, u_{jm})
 \end{aligned}$$

and 
$$A_4 = \sum_{v_i \in V(G_1)} \frac{dv}{dx} \sum_{\substack{u_{ij} \in V_i(G_2) \\ v_k \in V(G_1)}} d_G(u_{ij}) d_G(v_k) d_G(u_{ij}, v_k).$$

Applying Lemmas 2.2 and 2.3,  $A_i (i = 1, 2, 3, 4)$  can be computed as follows:

$$\begin{aligned}
 A_1 &= \sum_{\{v_i, v_j\} \subseteq V(G_1)} d_G(v_i) d_G(v_j) d_G(v_i, v_j) \\
 &= (n_2 + 1)^2 \sum_{\{v_i, v_j\} \subseteq V(G_1)} [d_{G_1}(v_i) d_{G_1}(v_j)] d_{G_1}(v_i, v_j) = (n_2 + 1)^2 Gut(G_1), \tag{2.12}
 \end{aligned}$$

$$\begin{aligned}
 A_2 &= \sum_{v_i \in V(G_1)} \sum_{\{u_{ij}, u_{ik}\} \subseteq V_i(G_2)} d_G(u_{ij}) d_G(u_{ik}) d_G(u_{ij}, u_{ik}) \\
 &= \sum_{v_i \in V(G_1)} \left\{ 2 \sum_{\{u_{ij}, u_{ik}\} \subseteq V_i(G_2)} d_G(u_{ij}) d_G(u_{ik}) - \sum_{u_j u_k \in E(G_2)} d_G(u_{ij}) d_G(u_{ik}) \right\} \\
 &= \sum_{v_i \in V(G_1)} \left\{ 2 \sum_{\{u_{ij}, u_{ik}\} \subseteq V_i(G_2)} [d_{G_2}(u_{ij}) d_{G_2}(u_{ik}) + d_{G_1}(v_i) (d_{G_2}(u_{ij}) + d_{G_2}(u_{ik})) + d_G^2(v_i)] \right. \\
 &\quad \left. - \sum_{u_j u_k \in E(G_2)} (d_{G_2}(u_{ij}) d_{G_2}(u_{ik}) + d_{G_1}(v_i) [d_{G_2}(u_{ij}) + d_{G_2}(u_{ik})] + d_G^2(v_i)) \right\} \\
 &= \sum_{v_i \in V(G_1)} \left\{ 4m_2^2 - M_1(G_2) + 4(n_2 - 1)m_2 d_{G_1}(v_i) + n_2(n_2 - 1)d_G^2(v_i) \right. \\
 &\quad \left. - M_2(G_2) - d_G(v_i)M_1(G_2) - m_2 d_G^2(v_i) \right\} \\
 &= n_1(4m_2^2 - M_2(G_2)) - (n_1 + 2m_1)M_1(G_2) + 8m_1 m_2(n_2 - 1) + (n_2(n_2 - 1) - m_2)M_1(G_1), \tag{2.13}
 \end{aligned}$$

$$\begin{aligned}
 A_3 &= \sum_{\{v_i, v_j\} \subseteq V(G_1)} \sum_{\substack{u_{ik} \in V_i(G_2) \\ u_{jm} \in V_j(G_2)}} d_G(u_{ik}) d_G(u_{jm}) d_G(u_{ik}, u_{jm}) \\
 &= \sum_{\{v_i, v_j\} \subseteq V(G_1)} \sum_{\substack{u_{ik} \in V_i(G_2) \\ u_{jm} \in V_j(G_2)}} d_G(u_{ik}) d_G(u_{jm}) d_{G_1}(v_i, v_j) \\
 &\quad + 2 \sum_{v_i v_j \in E(G_1)} \sum_{\substack{u_{ik} \in V_i(G_2) \\ u_{jm} \in V_j(G_2)}} d_G(u_{ik}) d_G(u_{jm}) - \sum_{v_i v_j \in E_\Delta(G_1)} \sum_{\substack{u_{ik} \in V_i(G_2) \\ u_{jm} \in V_j(G_2)}} d_G(u_{ik}) d_G(u_{jm})
 \end{aligned}$$

$$\begin{aligned}
&= \sum_{\{v_i, v_j\} \subseteq V(G_1)} d_{G_1}(v_i, v_k) \sum_{\substack{u_{ik} \in V_i(G_2) \\ u_{jm} \in V_j(G_2)}} [d_{G_1}(v_i) + d_{G_2}(u_k)] [d_{G_1}(v_j) + d_{G_2}(u_m)] \\
&+ 2 \sum_{v_i v_j \in E(G_1)} \sum_{\substack{u_{ik} \in V_i(G_2) \\ u_{jm} \in V_j(G_2)}} [d_{G_1}(v_i) + d_{G_2}(u_k)] [d_{G_1}(v_j) + d_{G_2}(u_m)] \\
&- \sum_{v_i v_j \in E_\Delta(G_1)} \sum_{\substack{u_{ik} \in V_i(G_2) \\ u_{jm} \in V_j(G_2)}} [d_{G_1}(v_i) + d_{G_2}(u_k)] [d_{G_1}(v_j) + d_{G_2}(u_m)] \\
&= \sum_{\{v_i, v_j\} \subseteq V(G_1)} d_{G_1}(v_i, v_k) \left\{ n_2^2 d_{G_1}(v_i) d_{G_1}(v_j) + 2n_2 m_2 (d_{G_1}(v_i) + d_{G_1}(v_j)) + 4m_2^2 \right\} \\
&+ 2 \sum_{v_i v_j \in E(G_1)} \left\{ n_2^2 d_{G_1}(v_i) d_{G_1}(v_j) + 2n_2 m_2 (d_{G_1}(v_i) + d_{G_1}(v_j)) + 4m_2^2 \right\} \\
&- \sum_{v_i v_j \in E_\Delta(G_1)} \left\{ n_2^2 d_{G_1}(v_i) d_{G_1}(v_j) + 2n_2 m_2 (d_{G_1}(v_i) + d_{G_1}(v_j)) + 4m_2^2 \right\} \\
&= n_2^2 \text{Gut}(G_1) + 2n_2 m_2 \text{DD}(G_1) + 4m_2^2 \text{W}(G_1) + n_2^2 (2M_2(G_1) - T_2(G_1)) \\
&+ 2n_2 m_2 (2M_1(G_1) - T_1(G_1)) + 4m_2^2 (2m_1 - |E_\Delta(G_1)|). \tag{2.14}
\end{aligned}$$

$$\begin{aligned}
A_4 &= \sum_{v_i \in V(G_1)} \left\{ \sum_{\substack{u_{ij} \in V_i(G_2) \\ v_k \in V(G_1) \\ v_i \neq v_k}} d_G(u_{ij}) d_G(v_k) d_{G_1}(v_i, v_k) + 2 \sum_{u_{ij} \in V_i(G_2)} d_G(u_{ij}) d_G(v_i) \right\} \\
&= (n_2 + 1) \sum_{v_i \in V(G_1)} \left\{ \sum_{v_k \in V(G_1)} d_{G_1}(v_i, v_k) d_{G_1}(v_k) (2m_2 + n_2 d_{G_1}(v_i)) \right. \\
&\quad \left. + 2 (n_2 d_{G_1}^2(v_i) + 2m_2 d_{G_1}(v_i)) \right\} \\
&= 2(n_2 + 1)(m_2 \text{DD}(G_1) + n_2 \text{Gut}(G_1) + n_2 M_1(G_1) + 4m_1 m_2). \tag{2.15}
\end{aligned}$$

Using (2.12), (2.13), (2.14) and (2.15) in (2.11), we obtain the required result.  $\square$

**Corollary 2.15** *If  $G_1$  is a triangle free graph, then the Gutman index of  $G = G_1 * G_2$  is given by*

$$\begin{aligned}
\text{Gut}(G) &= (2n_2 + 1)^2 \text{Gut}(G_1) + 2m_2(2n_2 + 1) \text{DD}(G_1) + 4m_2^2 \text{W}(G_1) \\
&- (n_1 + 2m_1) M_1(G_2) - n_1 M_2(G_2) + (n_2(3n_2 + 4m_2 + 1) - m_2) M_1(G_1) \\
&+ 2n_2^2 M_2(G_1) + 8m_1 m_2 [2n_2 + m_2] + 4n_1 m_2^2.
\end{aligned}$$

**Corollary 2.16** *If  $G_1 = H_1 \vee H_2$  (join of two connected graphs  $H_1$  and  $H_2$  with  $|V(H_1)| \geq 2$ ), then the Gutman index of  $G = G_1 * G_2$  is given by*

$$\begin{aligned} Gut(G) &= (2n_2 + 1)^2 Gut(G_1) + 2m_2(2n_2 + 1)DD(G_1) + 4m_2^2W(G_1) \\ &\quad - (n_1 + 2m_1)M_1(G_2) - n_1M_2(G_2) + (n_2(3n_2 + 2m_2 + 1) - m_2)M_1(G_1) \\ &\quad + n_2^2M_2(G_1) + 4m_1m_2[4n_2 + m_2] + 4n_1m_2^2. \end{aligned}$$

**Lemma 2.17**([8]) *Let  $P_n$  and  $C_n$  denote the path and the cycle on  $n$  vertices, respectively. Then*

$$Gut(P_n) = (n - 1)(2n^2 - 4n + 3)/3$$

and

$$Gut(C_n) = \begin{cases} n^3/2, & \text{if } n \text{ is even,} \\ n(n^2 - 1)/2, & \text{if } n \text{ is odd.} \end{cases}$$

Applying Lemmas 2.7, 2.12 and 2.17 in Theorem 2.14, we obtain the following corollary.

**Corollary 2.18** (1) *For  $n, m \geq 3$ ,  $Gut(P_n * P_m) = (6n^3 - 12n^2 + 74n - 86)m^2 - (6n^2 + 62n - 60)m + 43n - 27$ ;*

$$(2) \quad Gut(C_{2n} * C_m) = 4n(9m^2n^2 + 6mn^2 + 32m^2 + n^2 - 8m);$$

(3) *For  $n \neq 1$ ,  $Gut(C_{2n+1} * C_m) = 2(2n + 1)(9m^2n^2 + 9m^2n + 6mn^2 + 32m^2 + 6mn + n^2 - 8m + n)$ ;*

$$(4) \quad \text{For } n \neq 1, \quad Gut(C_{2n+1} * P_m) = 2(2n + 1)(9m^2n^2 + 9m^2n + 32m^2 - 36m + 21);$$

$$(5) \quad Gut(C_{2n} * P_m) = 4n(9m^2n^2 + 32m^2 - 36m + 21);$$

(6)  $Gut(P_n * C_m) = 6(m + 1/3)^2n^3 - \frac{1}{3}((36m^2 + 30m + 6)n^2 + (222m^2 - 18m + 7)n) - 86m^2 + 4m - 1$ .

## Acknowledgement

The second author is thankful to UGC, New Delhi, for UGC-JRF, under which this work has been done.

## References

- [1] C. Adiga, Malpashree R, Rakshith B. R, N. Anitha, Some topological indices of edge corona of two graphs, *Iranian J. Math. Chem.*, accepted.
- [2] V. Andova, D. Dimitrov, J. Fink, R. Škrekovski, Bounds on Gutman index, *MATCH Commun. Math. Comput. Chem.*, 67 (2012) 515–524.
- [3] P. Dankelmann, I. Gutman, S. Mukwembi, H.C. Swart, On the degree distance of a graph, *Discrete Appl. Math.*, 157 (2009) 2773–2777.



- [4] A. A. Dobrynin, R. Entringer, I. Gutman, Wiener index of trees: theory and applications, *Acta Appl. Math.*, 66 (2001) 211–249.
- [5] A. A. Dobrynin, I. Gutman, S. Klavžar, P. Žigert, Wiener index of hexagonal systems, *Acta Appl. Math.*, 72 (2002) 247–294.
- [6] A. A. Dobrynin, A. A. Kochetova, Degree distance of a graph: a degree analogue of the Wiener index, *J. Chem. Inf. Comput. Sci.*, 34 (1994) 1082–1086.
- [7] M. Essalih, M. E. Marraki and G. E. Hagri, Calculation of Some Topological Indices of Graphs, *J. Theor. Appl. Inf. Tech.*, 30 (2011) 122–127.
- [8] L. Feng and W. Liu, The maximal Gutman index of bicyclic graphs, *MATCH Commun. Math. Comput. Chem.*, 66 (2011) 699–708.
- [9] R. Frucht, F. Harary, On the corona of two graphs, *Aequationes Math.*, 4 (1970) 322–325.
- [10] I. Gutman, Selected properties of Schultz molecular topological index, *J. Chem. Inf. Comput. Sci.*, 34 (1994) 1087–1089.
- [11] I. Gutman, N. Trinajstić, Graph theory and molecular orbitals, total  $\pi$  electron energy of alternant hydrocarbons, *Chemical Physics Letters*, 17 (1972) 535–538.
- [12] I. Gutman, S. Klavžar, B. Mohar (eds.), Fifty years of the Wiener index, *MATCH Commun. Math. Comput. Chem.*, 35 (1997) 1–259.
- [13] G. Indulal, The spectrum of neighborhood corona of graphs, *Kragujevac J. Math.*, 35 (2011) 493–500.
- [14] M. Knor, P. Potočnik, R. Škrekovski, Relationship between the edge-Wiener index and the Gutman index of a graph, *Discrete Appl. Math.*, 167 (2014) 197–201.
- [15] V. Sheeba Agnes, Degree distance and Gutman index of corona product of graphs, *Trans. Combin.*, 4 (2015) 11–23.
- [16] I. Tomescu, Some extremal properties of the degree distance of a graph, *Discrete Appl. Math.*, 98 (1999) 159–163.
- [17] A. I. Tomescu, Unicyclic and bicyclic graphs having minimum degree distance, *Discrete Appl. Math.*, 156 (2008) 125–130.
- [18] H. Wiener, Structural determination of paraffin boiling points, *J. Am. Chem. Soc.*, 69 (1947) 17–20.
- [19] Z. Yarahmadi, A. R. Ashrafi, The Szeged, vertex PI, first and second Zagreb indices of corona product of graphs, *Filomat*, 26:3 (2012) 467–472.

## Projective Dimension and Betti Number of Some Graphs

A. Alilo, J. Amjadi

Department of Mathematics Azarbaijan Shahid Madani University Tabriz, IR. Iran

N. Vaez Moosavi, S. Mohammadikhah

Department of Pure Mathematics, International Campus of Ferdowsi University of Mashhad

P.O.Box 1159-91775, Mashhad, Iran

E-mail: abbasalilou@yahoo.com, amjadi-jafar@yahoo.com, nazilamoosavi@gmail.com, s.mohamadi783@gmail.com

**Abstract:** Let  $G$  be a graph. Then  $(G)_i$  denotes a graph such that to every vertex adds  $i$  pendant edges. In this paper, we study the projective dimension and Betti number of some graph such as  $(S_n)_i, (K_{m,n})_i, \dots$

**Key Words:** Projective dimension, Betti number, graph.

**AMS(2010):** 13H10,05C75

### §1. Introduction

A *simple graph* is a pair  $G = (V, E)$ , where  $V = V(G)$  and  $E = E(G)$  are the sets of vertices and edges of  $G$ , respectively. A *path* is a walk that does not include any vertex twice, except that its first vertex might be the same as its last. A path with length  $n$  denotes by  $P_n$ . In a graph  $G$ , the *distance* between two distinct vertices  $x$  and  $y$ , denoted by  $d(x, y)$ , is the length of the shortest path connecting  $x$  and  $y$ , if such a path exists: otherwise, we set  $d(x, y) = \infty$ . The *diameter* of a graph  $G$  is  $\text{diam}(G) = \sup\{d(x, y) : x \text{ and } y \text{ are distinct vertices of } G\}$ . A *walk* is an alternating sequence of vertices and connecting edges. Also, a *cycle* is a path that begins and ends on the same vertex. A cycle with length  $n$  denotes by  $C_n$ . A graph  $G$  is said to be *connected* if there exists a path between any two distinct vertices, and it is *complete* if it is connected with diameter one. We use  $K_n$  to denote the complete graph with  $n$  vertices. For a positive integer  $r$ , a *complete  $r$ -partite* graph is one in which each vertex is joined to every vertex that is not in the some subset. The *complete bipartite* graph with part sizes  $m$  and  $n$  is denoted by  $K_{m,n}$ . The graph  $K_{1,n-1}$  is called a *star graph* in which the vertex with degree  $n - 1$  is called the center of the graph. For any graph  $G$ , we denote

$$N[x] = \{y \in V(G) : (x, y) \text{ is an edge of } G\} \cup \{x\}.$$

Recall that the *projective dimension* of an  $R$ -module  $M$ , denoted by  $pd(M)$ , is the length of the minimal free resolution of  $M$ , that is,

---

<sup>1</sup>Received February 19, 2016, Accepted November 16, 2016.

$$\text{pd}(M) = \max\{i \mid \beta_{i,j}(M) \neq 0 \text{ for some } j\}.$$

There is a strong connection between the topology of the simplicial complex  $\Delta$  and the structure of the free resolution of  $\mathbb{K}[\Delta]$ . Let  $\beta_{i,j}(\Delta)$  denotes the  $\mathbb{N}$ -graded Betti numbers of the Stanley-Reisner ring  $\mathbb{K}[\Delta]$ . To any finite simple graph  $G$  with the vertex set  $V(G) = \{x_1, \dots, x_n\}$  and the edge set  $E(G)$ , one can attach an ideal in the Polynomial rings  $R = \mathbb{K}[x_1, \dots, x_n]$  over the field  $\mathbb{K}$ , whose generators are square-free quadratic monomials  $x_i y_j$  such that  $(x_i, y_j)$  is an edge of  $G$ . This ideal is called the *edge ideal* of  $G$  and will be denoted by  $I(G)$ . Also the edge ring of  $G$ , denoted by  $\mathbb{K}(G)$  is defined to be the quotient ring  $\mathbb{K}(G) = R/I(G)$ . Edge ideals and edge rings were first introduced by Villarreal [11] and then they have been studied by many authors in order to examine their algebraic properties according to the combinatorial data of graphs. The most important Algebraic objects among these are Betti numbers and positive dimension. The aim of this paper is to investigate the above mentioned algebraic properties of  $(G)_i$ , where  $(G)_i$  is a graph such that to every vertex adds  $i$  pendent edges. In this paper, we denote  $S_n$  for a star graph with  $n + 1$  vertices.

## §2. The Projective Dimension of Some Graphs

In this section, we study the projective dimension of some graphs. We begin this section with the following results.

**Proposition 2.1**([6], Proposition 2.2.8) *If  $G$  is the disjoint union of the two graphs  $G_1$  and  $G_2$ , then  $\text{pd}(G) = \text{pd}(G_1) + \text{pd}(G_2)$ .*

**Corollary 2.2**([6], Corollary 2.2.9) *Let components are  $G_1, \dots, G_m$ . Then the projective dimension of  $G$  is the sum of the projective dimensions of  $G_1, \dots, G_m$ , i.e  $\text{pd}(G) = \sum_{i=1}^m \text{pd}(G_i)$ .*

Throughout this section,  $v$  will denote a vertex of  $T$  which has all but at most one of its neighbours of degree 1 ( and if it has exactly one neighbour then that neighbour also has degree 1 ). The neighbours of  $v$  will be denoted  $v_1, \dots, v_n$  such that  $v_1, \dots, v_{n-1}$  all have degree 1. Also the neighbours of  $v_n$  other than  $v$  will be denoted by  $w_1, \dots, w_m$ .

Let  $T$  denoted a forest and let  $T'$  denote the subgraph of  $T$  which is obtained by deleting the vertex  $v_1$  and let  $T''$  denote the subgraph of  $T$  which is obtained by deleting the vertices  $v, v_1, \dots, v_n$ . That is,  $T' = T \setminus T\{v_1\}$  and  $T'' = T \setminus \{v, v_1, \dots, v_n\}$ . Note that  $T'$  and  $T''$  must both be forests.

**Theorem 2.3**([6], Theorem 9.4.17) *Let  $p = \text{pd}(T)$ ,  $p' = \text{pd}(T')$  and  $p'' = \text{pd}(T'')$ . Then projective dimension of the forest  $T$  is equal to  $p = \max\{p', p'' + n\}$ .*

**Theorem 2.4**([6], Theorem 4.2.6) *If  $G$  is a graph such that  $G^c$  is disconnected, then  $\text{pd}(G) = |V(G)| - 1$ .*

**Lemma 2.5**([3], Lemma 3.2) *Let  $x$  be a vertex of a graph  $G$ . Then  $\text{pd}(G) \leq \max\{\text{pd}(G - N[x]) + \deg(x), \text{pd}(G - \{x\}) + 1\}$ .*

**Lemma 2.6**([3, Observation 4.5]) *The maximum size of a minimal vertex cover of  $G$  equals  $\text{BigHeight}(I(G))$ .*

In the following proposition, we investigate the projective dimension of graph  $G$  such that  $G$  is the graph obtained from  $S_n$  by adding  $i$  pendant edges to each vertex.

**Proposition 2.7** *If  $G$  is the graph obtained from  $S_n$  by adding  $i$  pendant edges to each vertex, then  $\text{pd}(G) = ni + 1$ .*

*Proof* Let the set  $\{u_0, u_1, \dots, u_n\}$  be vertex set of  $S_n$  and the set  $\{u_{j_1}, u_{j_2}, \dots, u_{j_i}\}$  be the leaves the adjacent with vertex  $u_i$  for  $0 \leq j \leq n$ . Then, by Theorem ??, we have

$$\text{pd}(G) = \max\{\text{pd}(G - \{u_1\}), \text{pd}(G - \{u_{1_1}, u_{1_2}, \dots, u_{1_i}, u_1, u_0\}) + i + 1\}.$$

Also, Theorem 2.4 and Corollary 2.2,

$$\text{pd}(G - \{u_{1_1}, u_{1_2}, \dots, u_{1_i}, u_1, u_0\}) + i + 1 = (n - 1)i.$$

By reusing of Theorem 2.3,

$$\text{pd}(G - \{u_{1_1}\}) = \max\{\text{pd}(G - \{u_{1_1}, u_{1_2}\}), ni\}.$$

So we have,

$$\text{pd}(G) = \max\{\text{pd}(G - \{u_{1_1}, u_{1_2}\}), ni + 1\}.$$

Continuing this process we have,

$$\text{pd}(G) = \max\{\text{pd}(G - \{u_{1_1}, u_{1_2}, \dots, u_{1_i}\}), ni + 1\}.$$

Now, let  $G_1 = G - \{u_{1_1}, u_{1_2}, \dots, u_{1_i}\}$ . Then with the use of Lemma 2.5, we obtain,

$$\text{pd}(G_1) \leq \max\{\text{pd}(G_1 - N[u_0]) + \deg(u_0), \text{pd}(G_1 - \{u_0\}) + 1\}.$$

Since  $\text{pd}(G_1 - N[u_0]) = 0$ ,  $\deg(u_0) = n + i$ , we have,

$$\text{pd}(G_1) \leq \max\{mi + n, (n - 1)i + 1\}.$$

Hence  $\text{pd}(G) = ni + 1$ . This completes the proof.  $\square$

In the next proposition, we study the projective dimension of graph  $G$  such that  $G$  is the graph obtained from  $K_{m,n}$  by adding  $i$  pendant edges to each vertex.

**Proposition 2.8** *If  $G$  is the graph obtained from  $K_{m,n}$  by adding  $i$  pendant edges to each vertex, then  $\text{pd}(G) = \max\{mi + n, ni + m\}$ .*

*Proof* We do proof by induction on  $n$ . Suppose that  $n = 1$  and  $m \geq 1$ . Then by Proposition 2.7, we have,  $\text{pd}(G) = \max\{mi + 1, i + m\} = mi + 1$ . Now, we may assume that  $n > 1$  and  $m > 1$ . Also, let the result is true for each  $K_{m,k}$  and  $k < n$ . Since the sets

$$\{x_1, x_2, \dots, x_n, y_{1_1}, y_{1_2}, \dots, y_{1_i}, \dots, y_{m_1}, y_{m_2}, \dots, y_{m_i}\},$$

and

$$\{y_1, y_2, \dots, y_m, x_{1_1}, x_{1_2}, \dots, x_{1_i}, \dots, x_{n_1}, x_{n_2}, \dots, x_{n_i}\},$$

are the two minimal vertex cover of maximal size. By the proof Lemma 2.6, we have

$$pd(G) \geq \text{Bight}(I(G)) = \max\{mi + n, ni + m\}.$$

On the other hand, by Lemma 2.5, we obtain

$$pd(G) \leq \max\{pd(G - N[x_1]) + m + i, pd(G - \{x_1\}) + 1\}.$$

Now, by Corollary 2.2,  $pd(G - N[x_1]) = (n - i)$ , and so by induction hypothesis,

$$pd(G - \{x_1\}) = \max\{mi + (n - 1), (n - 1)i + m\}.$$

Therefore

$$\begin{aligned} pd(G) &= \max\{ni + m, \max\{mi + (n - 1), (n - 1)i + m\}\} \\ &= \max\{mi + n, ni + m\}. \end{aligned}$$

Hence the result holds.  $\square$

**Corollary 2.9** *If  $G$  is the graph obtained from  $S_n \otimes S_m$  by adding  $i$  pendent edges to each vertex, then*

$$pd(G) = \max\{(mn + m)i + n + 1, (mn + n)i + m + 1\}$$

for  $m, n \geq 1$ . In particular,  $pd(S_n \otimes S_m) = mn + m + n - 1$ .

*Proof* Since  $S_n \otimes S_m = S_{mn} \cup K_{m,n}$ , we have for  $i \geq 1$ ,  $(S_n \otimes S_m)_i = (S_{mn})_i \cup (K_{m,n})_i$ . So by Corollary 2.2, Propositions 2.7 and 2.8, the result holds.  $\square$

**Lemma 2.10**([4, Lemma 5.1]) *Let  $I$  be a squar-free monomial ideal and let  $\Lambda$  be any subset of the variables. We relabel the variables so that  $\Lambda = \{x_1, \dots, x_n\}$ . Then either there exists a  $j$  with  $1 \leq j \leq i$  such that  $pd(S/I) = pd(S/(I, x_1, \dots, x_{j-1}) : x_j)$  or  $pd(S/I) = pd(S/(I, x_1, \dots, x_i))$ .*

**Lemma 2.11** *Let  $x$  be a vertex of a  $G$ . Then we have*

- (1)  $pd(G) = pd(G - \{x\}) + 1$  or  $pd(G - N[x]) + \deg(x)$ ;
- (2) If  $pd(G - N[x]) + \deg(x) \geq pd(G - \{x\}) + 1$ , then  $pd(G) = pd(G - N[x]) + \deg(x)$ .

*Proof* (1) By the proof of Lemma 2.5, we have

$$pd \left( \frac{R}{(I(G) : x)} \right) = pd(G - N[x]) + \deg(x),$$

and

$$pd \left( \frac{R}{(I(G), x)} \right) = pd(G - \{x\}) + 1.$$

Also, by Lemma 2.10, we have

$$pd(G) = pd \left( \frac{R}{(I(G) : x)} \right) \quad \text{or} \quad pd(G) = pd \left( \frac{R}{(I(G), x)} \right).$$

Hence the result part (1) holds.

(2) If  $pd(G - N[x]) + \deg(x) \geq pd(G - \{x\}) + 1$ , then by Lemma 2.5, we have,  $pd(G) \leq pd(G - N[x]) + \deg(x)$ . Now, we consider the following short exact sequence

$$0 \longrightarrow \frac{R}{(I(G) : x)} \longrightarrow \frac{R}{I(G)} \longrightarrow \frac{R}{(I(G), x)} \longrightarrow 0$$

Therefore,  $pd(G) = pd \left( \frac{R}{(I(G))} \right) \geq pd \left( \frac{R}{(I(G) : x)} \right) = pd(G - N[x]) + \deg(x)$ . Hence the result holds.  $\square$

In the following proposition, we investigate the projective dimension of graphs  $G$  and  $H$  such that  $G$  and  $H$  are graphs obtained from  $P_n$  and  $C_n$  by adding  $i$  pendant edges to each vertex, respectively.

**Proposition 2.12** *If  $G$  and  $H$  are graphs obtained from  $P_n$  and  $C_n$  by adding  $i$  pendant edges to each vertex, then*

- (1)  $pd(G) = \left\lceil \frac{n}{2} \right\rceil i + \left\lfloor \frac{n}{2} \right\rfloor$ ;
- (2)  $pd(H) = \begin{cases} \frac{n-1}{2}i + \frac{n+1}{2} & \text{if } n \text{ is odd,} \\ \frac{n}{2}i + \frac{n}{2} & \text{if } n \text{ is even.} \end{cases}$

*Proof* (1) we do proof by induction on  $n$ . If  $n = 2$ , then  $G$  is the double star graph  $(s_1)_i$ . By Example 2.1.17 in [6], we have  $pd(G) = i + 1$ . For  $n = 3$ , let  $G$  be the graph shown in Figure 1. Then  $pd(G - \{x\}) = pd(P_2)_i = pd(s_1)_i = i + 1$ .

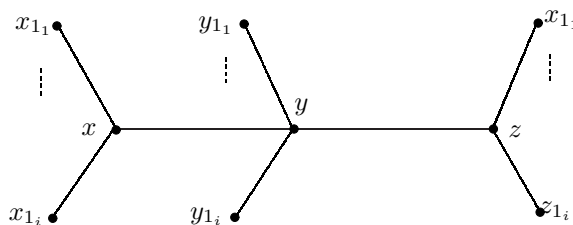
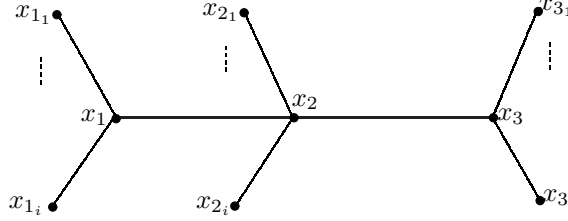

Figure 1

Also we have,  $pd(G - N[x]) = pd(s_i) = i$ . Hence  $pd(G - N[x]) + \deg(x) \geq pd(G - \{x\}) + 1$ , and so by Lemma 2.11,  $pd(G) = pd(G - N[x]) + \deg(x) = 2i + 1$ . Now, let  $n \geq 4$  and suppose that for each  $P_n$  of order less than  $n$  the result is true. Let  $G$  be the graph shown in Figure 2.



**Figure 2**

By the inductive hypothesis, we obtain

$$pd(G - \{x_1\}) = pd(P_{n-1})_i = \left\lceil \frac{n-1}{2} \right\rceil i + \left\lfloor \frac{n-1}{2} \right\rfloor,$$

and

$$pd(G - N[x_1]) = pd(P_{n-2})_i = \left\lceil \frac{n-2}{2} \right\rceil i + \left\lfloor \frac{n-2}{2} \right\rfloor.$$

Hence by Lemma 2.11, the proof is complete.

(2) First, Assume that  $n$  is a odd number. Then  $H - \{x_1\} = (P_{n-1})_i$ , and so  $H - N[x_1] = (P_{n-3})_i$ . It follows from part (1) and Lemma 2.11,

$$\begin{aligned} pd(H) &= pd(H - \{x_1\}) + 1 = pd(P_{n-1})_i + 1 \\ &= \left\lceil \frac{n-1}{2} \right\rceil i + \left\lfloor \frac{n-1}{2} \right\rfloor + 1 = \frac{n}{2}i + \frac{n}{2} \end{aligned}$$

or

$$\begin{aligned} pd(H) &= pd(G - N[x_1]) + \deg(x_1) = pd(P_{n-3})_i + i + 2 \\ &= \left\lceil \frac{n-3}{2} \right\rceil i + \left\lfloor \frac{n-3}{2} \right\rfloor + i + 2 = \frac{n}{2}i + \frac{n}{2}. \end{aligned}$$

Hence the result hold. □

### §3. The Betti Number of Some Graphs

In this section, we study the Betti number of two special graphs. We begin this section with the basic facts and the following results.

A *simplicial complex*  $\Delta$  over a set of vertices  $V = \{x_1, \dots, x_n\}$  is a subset of the powerset of  $V$  with that property that, whenever  $F \in \Delta$  and  $G \subseteq F$ , then  $G \in \Delta$ . The elements of  $\Delta$  are called *faces* and the dimension of a face is  $\dim(F) = |F| - 1$ , where  $|F|$  is the cardinality of  $F$ . Faces with dimension 0 are called vertices and those with dimension 1 are edges. A maximal face of  $\Delta$  with respect to inclusion is called a *facet* of  $\Delta$  and the dimension of  $\Delta$ ,  $\dim(\Delta)$ , is the maximum dimension of its faces. If  $\Delta$  has an only facet, then it is called a *simplex*. Let  $\Delta$  and  $\Delta'$  be two simplicial complexes with vertex sets  $V$  and  $V'$ , respectively. The union  $\Delta \cup \Delta'$  defines as the simplicial complex with the vertex set  $V \cup V'$  and  $F$  is a face of  $\Delta \cup \Delta'$  if and only if  $F$  is a face of  $\Delta$  or  $\Delta'$ . If  $V \cap V' = \emptyset$ , then the join  $\Delta * \Delta'$  is the simplicial complex on the vertex set  $V \cup V'$  with faces  $F \cup F'$ , where  $F \in \Delta$  and  $F' \in \Delta'$ . The *cone* of  $\Delta$ , denoted by  $\text{cone}(\Delta)$ , is the join of a point  $\{w\}$  with  $\Delta$ , that is,  $\text{cone}(\Delta) = \Delta * \{w\}$ . If  $F \in \Delta$ , then we define  $x_F = \prod_{x_i \in F} x_i \in R = \mathbb{K}[x_1, \dots, x_n]$  for some field  $\mathbb{K}$ . The Stanley-Reisner ideal of  $\Delta$ , denoted by  $I_\Delta$  is  $I_\Delta = \langle x_F \mid F \notin \Delta \rangle$  and the Stanley-Reisner ring of  $\Delta$  is  $\mathbb{K}[\Delta] = \frac{R}{I_\Delta}$ . Let  $\beta_{i,j}(\Delta)$  denotes the  $\mathbb{N}$ -graded Betti numbers of the Stanley-Reisner ring  $\mathbb{K}[\Delta]$ . one of the most well-known results is the Hochster's formula.

**Theorem 3.1**([9, Hochster's formula]) *For  $i > 0$ , the  $\mathbb{N}$ -graded Betti number  $\beta_{i,j}$  of a simplicial complex  $\Delta$  are given by*

$$\beta_{i,j}(\Delta) = \sum_{W \subseteq V(\Delta), |W|=j} \dim_{\mathbb{K}} \tilde{H}_{j-i-1}(\Delta|_W, \mathbb{K}).$$

**Lemma 3.2**([9]) *Let  $\Delta_1$  and  $\Delta_2$  be two simplicial complexes with disjoint vertex sets having  $m$  and  $n$  vertices, respectively. Also, let  $\Delta = \Delta_1 \cup \Delta_2$ . Then the  $\mathbb{N}$ -graded Betti numbers  $\beta_{i,d}(\Delta)$  can be expressed as*

$$\begin{cases} \sum_{j=0}^{d-2} \{\beta_{i-j,d-j}(\Delta_1) + \beta_{i-j,d-j}(\Delta_2)\} & \text{if } d \neq i+1, \\ \sum_{j=0}^{d-2} \{\beta_{i-j,d-j}(\Delta_1) + \beta_{i-j,d-j}(\Delta_2)\} + \sum_{j=1}^{d-1} & \text{if } d = i+1. \end{cases}$$

**Lemma 3.3**([9]) *Let  $G$  and  $H$  be two simple graphs whose vertex sets are disjoint. Then  $\Delta_{G*H} = \Delta_G \cup \Delta_H$  is the disjoint union of two simplicial complexes.*

**Lemma 3.4**([6]) *If  $H$  is the induced subgraph of  $G$  on a subset of the vertices of  $G$ , then  $\beta_{i,d}(H) \leq \beta_{i,d}(G)$  for all  $i$ .*

**Proposition 3.5**([11, Proposition 5.2.5]) *If  $\Delta$  is a simplicial complex and  $\text{cn}(\Delta) = w * \Delta$  its cone, then*

$$\tilde{H}_p(\text{cn}(\Delta), \mathbb{K}) = 0,$$

for all  $p$ .

In the following theorem, we find a lower bound for the Betti number of graph  $(K_{m,n})_i$ .



**Theorem 3.6** Let  $G = (K_{m,n})_i$ . Then

$$\beta_l(G) \geq \max\left\{ \sum_{j+k=l+1} \binom{mi+n}{j} \binom{m}{k}, \sum_{j+k=l+1} \binom{ni+m}{j} \binom{n}{k} \right\}.$$

*Proof* Suppose that  $X = \{x_1, \dots, x_m\}$  and  $Y = \{y_1, \dots, y_n\}$  be two parts of graph  $K_{m,n}$ . Also, let  $X_r = \{x_{r_1}, \dots, x_{r_i}\}$  and  $Y_s = \{y_{s_1}, \dots, y_{s_i}\}$  be the leaves, which are adjacent to  $x_r$  and  $y_s$ , respectively for  $1 \leq r \leq m$  and  $1 \leq s \leq n$ . Now, let  $G_1 = (K_{m,n})_i - \cup Y_s$ . Then it is easy to see that  $\Delta G_1 = \Delta_1 \cup \Delta_2$  such that  $\Delta_1 = \langle \{x_1, \dots, x_m\} \rangle$ , and  $\Delta_2 = \langle \{y_1, \dots, y_n, x_{1_2}, \dots, x_{1_i}, \dots, x_{m_1}, \dots, x_{m_i}\} \rangle$ . Since  $\Delta_1$  and  $\Delta_2$  are simplexes, we have by Proposition ??,  $\tilde{H}_i(\Delta_1, \mathbb{K}) = \tilde{H}_i(\Delta_2, \mathbb{K}) = 0$  for all field  $\mathbb{K}$ . Now, let  $W \neq \emptyset$ . If  $W \subseteq V(\Delta_1)$  or  $W \subseteq V(\Delta_2)$ , then  $\Delta_W$  is a simplex. So for all  $i$ ,  $\tilde{H}_i(\Delta_W, \mathbb{K}) = 0$ . Therefore, Suppose that  $W \cap V(\Delta_1) \neq \emptyset$  and  $W \cap V(\Delta_2) \neq \emptyset$ , and so  $\Delta_W$  is a simplicial complex with two connected. Thus for all  $j$ , we have,

$$\tilde{H}_j(\Delta_W, \mathbb{K}) = \begin{cases} 0 & j \neq 0, \\ \mathbb{K} & j = 0. \end{cases}$$

If  $d = l + 1$ , the by Hochster's formula, we have

$$\begin{aligned} \beta_{l,d}(G_1) &= \sum_{W \subseteq V(\Delta), |W|=d} \dim \tilde{H}(\Delta_W, \mathbb{K}) = \sum_{W \subseteq V(\Delta), |W|=d} 1 \\ &= \binom{mi+n}{1} \binom{m}{l} + \binom{mi+n}{2} \binom{m}{l-1} \\ &\quad + \dots + \binom{mi+n}{l} \binom{m}{1} \\ &= \sum_{j+k=l+1} \binom{mi+n}{j} \binom{m}{k}. \end{aligned}$$

Therefore

$$\beta_l(G_1) = \sum_{d=1}^{|V(G_1)|} \beta_{l,d}(G_1) = \sum_{j+k=l+1} \binom{mi+n}{j} \binom{m}{k}.$$

It follows by Lemma 3.4,  $\beta(G) \geq \sum_{j+k=l+1} \binom{mi+n}{j} \binom{m}{k}$  with using an argument similar, we can see that  $\beta(G) \geq \sum_{j+k=l+1} \binom{mi+n}{j} \binom{m}{k}$ . This completes the proof.  $\square$

As an immediate consequence of the preceding result, we obtain.

**Corollary 3.7** *Let  $G = (S_n)_i$ . Then*

$$\beta_l(G) \geq \max\left\{ \sum_{j+k=l+1} \binom{ni+1}{j} \binom{n}{k}, \binom{n+i}{l} \right\}.$$

*Proof* With assume that  $m = 1$ , the result follows from Theorem 3.5.  $\square$

## References

- [1] R. Allan and R. laskar, On domination and independent domination numbers of a graph, *Discrete Math.*, 23 (1978), no. 2, 73-76.
- [2] H. Dao, C. Huneke, and J. Schweig, Projective dimension and independence complex homology, in preparation.
- [3] H. Dao, C. Huneke, and J. Schweig, Bounds on the regularity and projective dimension of ideals associated to graphs, preprint 2011.
- [4] H. Dao and J. Schweig, Projective dimension, graph domination parameters and independence complex homology, *arXiv*: 1110.2841v2 [math. AC] 22 Oct. 2001.
- [5] A. Dochtermann and A. Engstrom, Algebraic properties of edge ideals via combinatorial topology, *Electron. J. Combin.*, 16 (2009), Special volume in honor of Anders Bjorner, Research Paper 2.
- [6] S. Jacques, Betti numbers of graph ideals, *arXiv*: math/0410107v1 [math. AC] 5 Oct. 2004.
- [7] K. Kimura, Non-vanishingness of Betti numbers of edge ideals, Preprint (2011) *arXiv*: 1110.2333v2.
- [8] S. Morey and R. Villarreal, Edge ideals: algebraic and combinatorial properties, Preprint (2010), *arXiv*: 1012.5329v3.
- [9] A. Mousivand, Algebraic properties of product of graphs, *arXiv*: 1101.0515v2 [math. AC], 7 Jan. 2011.
- [10] C. Peskine and L. Szpiro, Domination projective finite et cohomologie locale, *Inst. Hautes Etudes Sci. Publ. Math.*, 42 (1973) 47-119.
- [11] R. H. Villarreal, *Monomial Algebras*, CRC Press, 2001.
- [12] N. Terai, Alexander duality theorem and Stanley-Reisner rings, *Free Resolutions of Coordinate Rings of Projective Varieties and Related Topics (Japanese) (Kyoto, 1998)*, *Surikaisekikenkyusho Kokyuroku*, No. 1078 (1999), 174-184.

## $k$ -Metric Dimension of a Graph

B.Sooranarayana<sup>1</sup>, S.Kunikullaya<sup>2</sup> and N. N.Swamy<sup>3</sup>

1. Department of Mathematical & Computational Studies

Dr.Ambedkar Institute of Technology, Bengaluru, Karnataka, India

2. Department of Mathematics

K. V. G. College of Engineering, Sullia, Dakshina Kannada, Karnataka, India

3. Department of Mathematics

University College of Science, Tumkur University, Karnataka, India

E-mail: dr\_bsnrao@dr-ait.org, shreedhar.k@rediffmail.com, narahari\_nittur@yahoo.com

**Abstract:** In a connected graph  $G(V, E)$ , a set  $S \subseteq V$  is said to be a  $k$ -resolving set of  $G$ , if for every pair of distinct vertices  $u, v \in V - S$ , there exists a vertex  $w \in S$  such that  $|d(u, w) - d(v, w)| \geq k$  for some  $k \in \mathbb{Z}^+$ . Among all  $k$ -resolving sets of  $G$ , a set having minimum cardinality is called a  $k$ -metric basis of  $G$  and its cardinality is called the  $k$ -metric dimension of  $G$ , denoted by  $\beta_k(G)$ . In this paper, we characterize graphs with prescribed  $k$ -metric dimension. We also extend some of the earlier known results on metric dimension.

**Key Words:** Metric dimension,  $k$ -metric dimension, landmarks.

**AMS(2010):** 05C12

### §1. Introduction

All graphs considered in this paper are simple, finite, undirected and connected. A vertex  $w \in V(G)$  is said to resolve a pair of vertices  $u, v \in V(G)$  if  $d(u, w) \neq d(v, w)$ . A set  $S \subseteq V(G)$  resolves  $G$  if every pair of distinct vertices of  $G$  is resolved by some vertex in  $S$ . Further, the set  $S$  is called a *resolving set* of  $G$ . In other words, a resolving set of  $G$  is a set  $S = \{w_1, w_2, \dots, w_t\}$  of vertices in  $G$  such that for each  $u \in V(G)$ , the vector  $r(u|S) = (d(u, w_1), d(u, w_2), \dots, d(u, w_t))$  uniquely identifies  $u$ . The  $k$ -vector  $r(u|S)$  is called the *metric code*,  *$S$ -location* or  *$S$ -code* of  $u \in V(G)$ . A resolving set of minimum cardinality in a graph is called a *minimum resolving set* or *metric basis*, the elements of which, are called *landmarks*. The *metric dimension* of  $G$ , denoted by  $\beta(G)$ , is the cardinality of a minimum resolving set in  $G$ .

The concept of resolving sets for a connected graph was introduced in the year 1975 by Slater [15] using the term *locating set*. He called the minimum resolving set a *reference set* and the cardinality of a reference set the *locating number* of the graph. In fact, resolving sets were studied much earlier in the context of the coin-weighing problem [3, 4, 8]. In the year 1976, Harary and Melter [11] independently introduced these concepts, however, under different terminologies. They used the term *metric dimension* instead of locating number. Since then,

---

<sup>1</sup>Received January 25, 2016, Accepted November 18, 2016.

a significant amount of work has been carried out on resolving sets [2, 18, 23, 21, 17, 19, 7, 12, 25]. Also, there have been many instances where the concept of resolving sets has arisen, some of which include navigation of robots, solution of the Mastermind game and network discovery & verification.

The following are some of the results on metric dimension obtained by various authors and are used for immediate reference in the subsequent sections of this paper.

**Theorem 1.1**([Khuller, Raghavachari and Rosenfeld, [13]) *For a simple connected graph  $G$ ,  $\beta(G) = 1$  if and only if  $G \cong P_n$ .*

**Theorem 1.2**([Harary and Melter [11]) *For any positive integer  $n$ ,  $\beta(G) = n - 1$  if and only if  $G \cong K_n$ .*

**Theorem 1.3**(Chartrand, Erwin, Harary and Zhang [6]) *If  $G$  is a connected graph of order  $n$ , then  $\beta(G) \leq n - \text{diam}(G)$ .*

**Lemma 1.4** *For any connected graph  $G$  on  $n$  vertices which is not a path,*

$$2 \leq \beta(G) \leq n - \text{diam}(G).$$

In this paper, we establish certain bounds on  $k$ -metric dimension  $\beta_k(G)$ , introduced by Sooryanarayana [22], as a generalization of metric dimension. Further, we obtain a bound on the degree of a vertex and order of a graph in terms of its  $k$ -metric dimension. We also characterize graphs  $G$  with  $\beta_k(G) = k$ .

## §2. $k$ -Metric Dimension

The  $k$ -metric dimension  $\beta_k(G)$  was introduced by Sooryanarayana in [22] as a generalization to metric dimension. In particular, some work was carried out by Geetha and Sooryanarayana [24] for  $k = 2$ .

**Definition 2.1** *Let  $G(V, E)$  be a connected graph and  $l, k \in \mathbb{Z}^+$  with  $k \leq l$ . A subset  $S$  of  $V$  is said to be a  $(l, k)$ -resolving set of  $G$ , if for every  $u, v \in V - S$  and  $u \neq v$ , there exists a vertex  $w \in S$  with the property that  $k \leq |d(u, w) - d(v, w)| \leq l$ . Further if  $l \geq \text{diam}(G)$ , then every  $(l, k)$ -resolving set is simply called a  $k$ -resolving set.*

**Definition 2.2** *A  $k$ -resolving set  $S$  is said to be a minimal  $k$ -resolving set if none of its proper subsets is a  $k$ -resolving set. Further a minimal  $k$ -resolving set of minimum cardinality is called a lower  $k$ -metric basis or simply a  $k$ -metric basis of  $G$  and is denoted by  $S_k$  and its cardinality is called the  $k$ -metric dimension of  $G$  and is denoted by  $\beta_k(G)$ .*

Some of the results that follow directly from the above definition are stated below.

**Remark 2.3** For any graph  $G$  on  $n$  vertices,  $1 \leq \beta_k(G) \leq n - 1$  for all  $k \in \mathbb{Z}^+$ . Further, if

$k \geq d$ , the diameter of  $G$ , then  $\beta_k(G) = n - 1$ .

**Remark 2.4** For  $k = 1$ , the  $k$ -metric dimension is same as metric dimension of a graph and for  $k \geq 2$ , it follows that  $\beta_k(G) \geq \beta(G)$ . Further, as  $1 \leq \beta(G) \leq \beta_k(G) \leq |V(G)|$ , it follows for any integer  $k \geq 1$  that  $\beta_k(K_n) = n - 1$  whenever  $n \geq 2$ .

**Lemma 2.5** For any integer  $k \geq 1$ , if  $S$  is a  $k$ -resolving set of a connected graph  $G$  and  $v \in S$ , then  $V - S$  has at most one pendant vertex adjacent to  $v$ .

*Proof* If two or more pendant vertices are adjacent to  $v$ , then for each vertex  $w \in S$  the distance from these vertices is identical. Hence  $S$  will not resolve these vertices.  $\square$

**Lemma 2.6** For any connected non-trivial graph  $G$  and an integer  $k \geq 2$ , if  $S$  is a  $k$ -resolving set of  $G$ , then  $d(x, y) \geq k$  for any two distinct vertices  $x, y \in V - S$ .

*Proof* Suppose, to the contrary, that  $d(x, y) \leq k - 1$  for some  $x, y \in V - S$ . Let  $w \in S$  be arbitrary. Without loss of generality, we assume that  $d(x, w) \geq d(y, w)$ . Then by triangular inequality, we have  $d(x, w) \leq d(x, y) + d(y, w) \Rightarrow d(x, w) - d(y, w) \leq d(x, y) \leq k - 1$ , a contradiction since  $w$  is arbitrary.  $\square$

If  $S_k$  is a  $k$ -metric basis for a graph  $G$  with  $|V - S_k| > 1$ , then, by Lemmas 2.5 and 2.6, it follows that

1.  $V - S_k$  is an independent set and  $S_k$  is a dominating set.
2. At least  $k - 1$  vertices in any shortest path between two distinct vertices of  $V - S_k$  are in  $S_k$ .
3. The cardinality of  $S_k$  is at least  $k - 1$ , i.e.,  $\beta_k(G) \geq k - 1$ .
4.  $n - i(G) \leq \beta_k(G) \leq n - 1$ , where  $i(G)$  denotes the independence number of the graph  $G$
5.  $\gamma(G) \leq \beta_k(G)$ , where  $\gamma(G)$  is the lower domination number of  $G$ .

Combining the above results, we have

**Lemma 2.7** For any  $k \in \mathbb{Z}^+$  and a connected non-trivial graph  $G$  on  $n$  vertices,

$$k - 1 \leq \beta_k(G) \leq n - 1.$$

The following result shows the cases where the lower bound in Lemma 2.7 is attained.

**Theorem 2.8** For any connected non-trivial graph  $G$  of order  $n$  and an integer  $k \in \mathbb{Z}^+$ ,  $\beta_k(G) = k - 1$  if and only if  $n = k$ .

*Proof* Let  $S_k$  be a metric basis with  $|S_k| = \beta_k(G) = k - 1$ . Then, as  $\beta_k(G) \leq n - 1$ , it follows that  $n \geq k$ . If  $n > k$ , then there exist at least two vertices  $x, y \in V - S_k$ . But then, the second condition stated above implies that  $\langle S_k \rangle \cong P_{k-1}$  and  $x$  is adjacent to one of the

end vertices of  $\langle S_k \rangle$  and  $y$  is adjacent to the other. Hence  $|V - S_k| = 2$  and  $G \cong P_{k+1}$ . This shows that  $\text{diam}(G) = k \Rightarrow |d(x, w) - d(y, w)| < k$  for any  $w \in S_k$ , a contradiction. Thus,  $n = k$ . The converse follows immediately from Remark 2.3 by noting the fact that  $k = n > n - 1 \geq \text{diam}(G)$ .  $\square$

**Corollary 2.9** *For any connected graph  $G$  and any integer  $k \geq 2$ ,  $\beta_k(G) = 1$  if and only if  $G \cong K_2$ .*

The following result is an extension of Theorem 1.2 and shows the cases where the upper bound in Lemma 2.7 is attained.

**Theorem 2.10** *For any connected non-trivial graph  $G$  on  $n$  vertices and any integer  $k \geq 1$ ,  $\beta_k(G) = n - 1$  if and only if  $\text{diam}(G) \leq k$ .*

*Proof* For  $k = 1$ , the result follows by Theorem 1.2. Suppose that  $k \geq 2$  and let  $G$  be a connected non-trivial graph on  $n$  vertices with  $\beta_k(G) = n - 1$ . Assume, to the contrary, that  $\text{diam}(G) \geq k + 1$ . Then there exists a pair of vertices  $u, v \in V$  such that  $d(u, v) = k + 1$ . Let  $P : u - x_1 - x_2 - \dots - x_k - v$  be a shortest path from  $u$  to  $v$ . Let  $S = V - \{x_1, v\}$ . Then  $V - S = \{x_1, v\}$  and for these  $x_1, v \in V - S$ , the vertex  $u \in S$  is such that  $d(u, v) - d(u, x) = (k + 1) - 1 = k$ . So,  $S$  is a  $k$ -resolving set of  $G$  and hence  $\beta_k(G) \leq |S| = n - 2$ , a contradiction. The converse follows from the fact that for any three distinct vertices  $x, y$  and  $u$  in  $G$ ,  $|d(x, u) - d(y, u)| \leq k - 1$  since  $\text{diam}(G) \leq k$ .  $\square$

**Remark 2.11** From Theorem 2.10, it follows for any  $k \geq 2$  that the  $k$ -metric dimension of the graphs on  $n$  vertices such as, Petersen graph, complete  $p$ -partite graphs for any  $p, 2 \leq p \leq n$ ,  $H + K_1$  for any graph  $H$  on  $n - 1$  vertices, etc., is  $n - 1$ .

### §3. Bounds on Order of a Graph and Degree of a Vertex in Terms of $k$ -Metric Dimension

In this section, we present some bounds on the order of a graph and degree of a vertex in a graph in terms of its  $k$ -metric dimension.

**Theorem 3.1** *For any connected non-trivial graph  $G$  of order  $n$  and an integer  $k \geq 3$ , if  $\beta_k(G) = m$ , then  $m + 1 \leq n \leq m \binom{k+1}{k-1} + 1$  for odd  $k$  and  $m + 1 \leq n \leq m \binom{k+2}{k} + 1$  for even  $k$ .*

*Proof* The lower bound follows from Lemma 2.7. To establish the upper bound, consider a  $k$ -metric basis  $S_k$  for  $G$  with  $|S_k| = m$ . Then,  $V - S_k$  is totally disconnected and  $|V - S_k| = n - m$ . Since  $G$  is connected, by Lemma 2.6, the length of a shortest path between any two vertices  $u, v \in V - S_k$  should include at least  $k - 1$  vertices of  $S_k$  such that none of them is adjacent to any other vertex in  $V - S_k$ . Thus, for  $n - m$  vertices in  $V - S_k$ , we must have at least  $(n - m - 1) \lfloor \frac{k-1}{2} \rfloor$  distinct vertices in  $S$ .  $\square$

**Remark 3.2** The above theorem need not be true for the case  $k = 2$ . For instance, for the graph shown in Figure 1, the set  $S_2 = \{w_1, w_2, w_3\}$  is a metric basis with  $m = 3$  and  $n = 8$ .

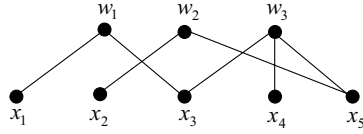

**Figure 1** A graph  $G$  on 8 vertices with  $\beta_2(G) = 3$

**Theorem 3.3** For any connected non-trivial graph  $G$  of order  $n$ , if  $\beta_2(G) = m$ , then  $m + 1 \leq n \leq \frac{m(m + 3)}{2}$ .

*Proof* The lower bound follows from Lemma 2.7. For the upper bound, let  $S_k$  be a  $k$ -metric basis for  $G$  with  $|S_k| = m$  with  $w_1, w_2, \dots, w_m$  being the vertices in  $S_k$ . Let  $N_{\bar{S}_k}(w_j)$  denote the set of vertices in  $V - S_k$  adjacent to the vertex  $w_j$ , for  $1 \leq j \leq m$ . Then for each pair of vertices  $x, y \in N_{\bar{S}_k}(w_1)$ ,  $S_k$  should contain at least one vertex  $w_i$  which is adjacent to exactly one of these vertices (clearly  $w_i \neq w_1$ ). Hence for the vertex  $w_1 \in S_k$ , the set  $S_k$  should contain at least  $N_{\bar{S}_k}(w_1) - 1$  new vertices other than  $w_1$ . This is possible only if  $N_{\bar{S}_k}(w_1) \leq m$ . We now define  $N(w_j)$  recursively as (i)  $N(w_1) = N_{\bar{S}_k}(w_1)$  and (ii) for  $j \geq 2$ ,  $N(w_j) = N_{\bar{S}_k}(w_j) - N_{\bar{S}_k}(w_{j-1})$ . Then, for each pair of vertices in  $x, y \in N(w_2)$ , we require at least  $N(w_2) - 1$  vertices in  $S_k - \{w_1, w_2\}$  adjacent to exactly one of these vertices (since  $N(w_1) \cap N(w_2) = \emptyset$ ). This is possible only if  $N(w_2) \leq m - 1$ . Continuing the same argument, we get, for each  $1 \leq j \leq m$ , that  $N(w_j) \leq m - j + 1$ . Further, since the graph  $G$  is connected and the set  $V - S_k$  is independent, the way  $N(w_j)$  is constructed implies that

$$|V - S_k| = \sum_{j=1}^m N(w_j) = \sum_{j=1}^m (m - j + 1) = \frac{m(m + 3)}{2}. \quad \square$$

**Lemma 3.4** For any integer  $k \geq 2$  and a  $k$ -resolving set  $S$  of a graph  $G$  of order  $n$  with  $|S| \leq n - 2$ , if  $v \in S$  is a vertex that lies in a shortest path between two vertices  $x$  and  $y$  in  $V - S$ , then  $\deg(v) \leq |S| - k + 2$ .

*Proof* We prove the result in two cases based on whether  $v$  is adjacent to any vertex in  $V - S$  or not.

**Case 1.**  $x$  (similarly  $y$ ) is a vertex adjacent to  $v$ .

In this case any shortest  $xy$ -path  $P$  should contain at least  $k - 1$  vertices of  $S$  for any other vertex  $y \in V - S$ . Such a vertex  $y$  exists as  $|V - S| \geq 2$ . Further, we note that exactly two vertices in  $P$  are adjacent to  $v$ .

**Subcase 1**  $P$  contains exactly  $k - 1$  vertices of  $S$ .

In such a case,  $v$  is adjacent to at most  $|S| - (k - 1)$  vertices of  $S - P$ . Further if  $v$  is adjacent to exactly  $|S| - k + 1$  vertices of  $S - P$  then no vertex  $w \in S$  will resolve  $x$  and  $y$  since in this case  $d(x, y) = k$  and  $d(x, w) = 2, d(y, w) \leq k$ . Hence  $v$  is adjacent to at most  $|S| - k$

vertices in  $S - P$ . Now if  $v$  is adjacent to any other vertex in  $z \in V - S$ , then  $k = 2$  since  $d(x, z) = 2$ . Thus, in order to resolve  $x$  and  $z$ , we require a vertex  $w \in S$  non adjacent to  $v$ . This shows that  $v$  is adjacent to a vertex in  $V - S$  only by being non-adjacent to a vertex in  $S$ . Thus  $\deg(v) \leq |S| - k + 2$ .

**Subcase 2.**  $P$  contains more than  $k - 1$  vertices of  $S$ .

In this case  $v$  is adjacent to at most  $|S| - k$  vertices of  $S$  not in  $P$  and the vertex adjacent to  $y$  in  $P$  will resolve  $x$  and  $y$ . Hence  $\deg(v) \leq |S| - k + 2$ .

**Case 2.**  $v$  is not adjacent to any vertex in  $V - S$ .

In this case  $v$  is adjacent to exactly two vertices in  $P$  and at most  $|S| - (l(P) - 1)$  vertices in  $S - P$ . However, as discussed earlier, if  $v$  is adjacent to exactly  $|S| - (l(P) - 1)$  vertices in  $S - P$ , then no vertex in  $S$  will resolve  $x$  and  $y$  unless  $l(P) > k$ , which implies that  $\deg(v) \leq |S| - k + 2 = |S| - k + 2$ .  $\square$

**Lemma 3.5** *For any integer  $k \geq 2$  and a  $k$ -resolving set  $S$  of a graph  $G$  of order  $n$  with  $|S| \leq n - 2$ , if  $v \in S$  is a vertex not in any shortest path between any two vertices  $x$  and  $y$  in  $V - S$ , then  $\deg(v) \leq |S| - k + 1$ .*

*Proof* The vertex  $v$  is adjacent to at most two adjacent vertices in a shortest path  $P$  between two vertices  $x$  and  $y$  in  $V - S$ . Otherwise,  $v$  lies in a shortest  $xy$ -path or  $P$  will not remain a shortest path.

**Case 1.**  $v$  is adjacent to two adjacent vertices  $u_1$  and  $u_2$  in  $P$ .

In this case no vertex  $z \in V - S$  is adjacent to  $v$ . Otherwise, it is easy to observe that  $v$  lies in a shortest path between  $x$  and  $z$  which is not possible. Also, neither  $v$  nor any vertex  $v_1$  adjacent to  $v$  will resolve  $x$  and  $y$  whenever  $l(P) \leq k$ . Without loss of generality, let  $d(x, v) \geq d(y, v)$  and  $u_1$  be nearer to  $x$  than  $u_2$ . Then  $d(x, v) \geq d(x, u_1)$ . If not, extending  $xv$ -path to  $u_2$  and then from  $u_2$  to  $y$  along  $P$  yields an  $xy$ -path containing  $v$  that has length at most that of  $P$ , a contradiction. Also  $d(x, v) \leq d(x, u_1) + 1$  as  $v$  is adjacent to  $u_1$  which implies that  $d(x, u_1) \leq d(x, v) \leq d(x, u_1) + 1$ . Similarly  $d(y, u_2) \leq d(y, v) \leq d(y, u_2) + 1$ . Hence  $|d(x, v) - d(y, v)| \leq |d(x, u_1) + 1 - d(y, u_2)| = |d(x, u_2) - d(y, u_2)| = |d(x, u_2) + d(y, u_2) - 2d(y, u_2)| = |l(P) - 2d(x, u_2)| = |l(P) - 2| = k - 2 < k$ , a contradiction. Similarly we can show that  $v_1$  will not resolve  $x$  and  $y$ . Thus,  $l(P) \geq k + 1$  so that  $v$  is adjacent to two vertices in  $P$  and at most  $|S| - k - 1$  vertices of  $S - V(P)$ . Hence  $\deg(v) \leq |S| - k + 1$ .

**Case 2.**  $v$  is adjacent to at most one vertex  $u_1$  in  $P$ .

In this case  $v$  can be adjacent to at most  $|S| - k$  elements of  $S - V(P)$ . Further, if  $v$  is adjacent to any vertex in  $V - S$ , then  $k \leq 4$ . When  $k = 3$  or  $4$  and  $v$  is adjacent to exactly one vertex  $z \in V - S$ , we require at least one vertex in  $S - V(P)$  not adjacent to  $v$  to resolve each pair of vertices in  $\{x, y, z\}$ . When  $k = 2$  and  $v$  is adjacent to  $z_1, z_2, z_3, \dots, z_i$  in  $V - S$ , we require  $i$  vertices in  $S$  not adjacent to  $v$  to resolve each pair in  $\{x, y, z_1, z_2, \dots, z_i\}$ . Hence  $\deg(v) \leq |S| - k$ .

Thus, in each of the cases, we see that  $\deg(v) \leq |S| - k + 1$ .  $\square$



The following lemma is based on the fact that the set  $V - S$  is an independent set and for each  $x, y \in V - S$ ,  $d(x, y) \geq k$ , the vertex  $x$  cannot be adjacent to at least  $k - 1$  vertices in  $S$ .

**Lemma 3.6** For any integer  $k \geq 2$  and a  $k$ -resolving set  $S$  of a graph  $G$  of order  $n$  with  $|S| \leq n - 2$ , if  $v \in V - S$ , then  $\deg(v) \leq |S| - k + 1$ .

Summarizing the above results, we have the following theorem.

**Theorem 3.7** For any integer  $k \geq 2$  and a graph  $G$  of order  $n \geq k$

$$\Delta(G) \leq \beta_k(G) - k + 2.$$

In the following theorem, we establish a bound on the order of a graph in terms of its  $k$ -metric dimension and diameter.

**Theorem 3.8** Suppose  $G$  is a graph on  $n$  vertices with diameter  $d \geq 2$  and metric dimension  $\beta_k(G) = m$ . Then

$$n \leq m + 1 + \binom{m}{k} \sum_{i=1}^{d-1} (d - i - k + 1)^{m-k}.$$

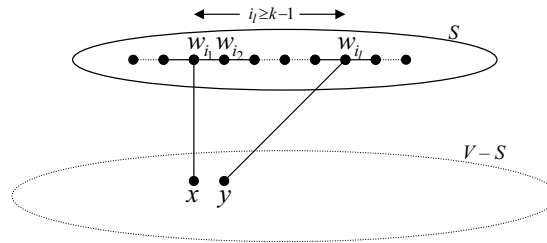

**Figure 2** A  $k$ -resolving set for the proof of Theorem 3.8.

*Proof* Let  $S_k$  be a  $k$ -resolving set with  $|S - k| = m$  and  $x, y \in V - S_k$ . Then, as  $d(x, y) \geq k$ , there are vertices  $w_{i_1}, w_{i_2}, \dots, w_{i_l}$  of  $S_k$  in a shortest  $xy$ -path, where  $i_l \geq k - 1$ . The coordinates of the vertex  $x$  corresponding to these  $i_l$  vertices are respectively  $1, 2, \dots, l$  and that of the vertex  $y$  are  $l, l - 1, \dots, 1$ . Hence these coordinates are fixed. Now, for any other  $w_j \in S_k$ , if the coordinate of  $x$  corresponding to  $w_j$  is  $l_j$ , then, as  $d(x, y) \geq k$ , the difference between  $l_j$  and coordinate of  $y$  corresponding to  $w_j$  should be at least  $k$ . Without loss of generality we assume  $d(x, w_j) \leq d(y, w_j)$ . Then, there are at most  $(d - l_j - k + 1)$  possibilities for the coordinate of  $y$  corresponding to the vertex  $w_j$ , where  $1 \leq l_j \leq d$ . Thus, there are at most

$$\sum_{i=1}^{d-1} (d - i - k + 1)^{m-k}$$

possible vectors that can be assigned for the vertex  $y$ . Therefore

$$|V - S_k| \leq \binom{m}{k} \sum_{i=1}^{d-1} (d - i - k + 1)^{m-k}. \quad \square$$

**§4. Characterization of Graphs with  $\beta_k(G) = k$**

S. Khuller *et al.* [13] in the year 1996, proved that  $\beta(G) = 1$  if and only if  $G$  is a path. In a similar manner, we characterize classes of graphs for which  $\beta_2(G) = 2$  in this section. Further, we establish a characterization of graphs with  $\beta_k(G) = k$ .

**Theorem 4.1** *For a connected graph  $G$ ,  $\beta_2(G) = 2$  if and only if  $G \cong P_3$  or  $P_4$  or  $P_5$  or  $C_3$ .*

*Proof* Let  $G$  be a connected graph such that  $\beta_2(G) = 2$  and  $S = \{w_1, w_2\}$  be a 2-metric basis of  $G$ . Then, by Corollary 2.9,  $|V| \geq 3$ .

We first claim that  $|V(G)| \leq 5$ . By Lemma 2.6, the set  $V - S$  is an independent set. So, as the graph  $G$  is connected, every vertex in  $V - S$  is adjacent to a vertex in  $S$ . If two or more vertices in  $V - S$  are adjacent to both the vertices in  $S$ , then by Definition 2.2, we see that  $S$  is not a 2-metric basis. Hence, at most one vertex can be adjacent to both the vertices in  $S$ . Similarly, at most one vertex  $x \in V - S$  can be adjacent to one of the vertices  $w_1$  or  $w_2$  (since if  $x, y \in V - S$  are adjacent to  $w_1$ , then, as  $S$  is a 2-metric basis,  $|d(x, w_2) - d(y, w_2)| \geq 2$  which is not possible because  $S$  is independent). Hence  $|V - S| \leq 3$  and  $|V| \leq 5$ .

Suppose  $|V| = 3$ , then  $G$  is one of  $P_3$  or  $C_3$  as  $G$  is connected. Similarly, if  $|V| = 4$ , then by Theorem 2.10,  $\text{diam}(G) > 2$  and hence  $G$  must be  $P_4$ . In the case of  $|V| = 5$ , we have  $|V - S| = 3$  and by the same argument, we see that at most one vertex can be adjacent to either  $w_1$  or  $w_2$  and at most one vertex can be adjacent to both  $w_1$  and  $w_2$ . If  $w_1$  and  $w_2$  are non-adjacent, then  $G$  is a path  $P_5$ . Else, as seen in Figure 3, for any vertex  $v \in V - S$ , we have  $1 \leq d(v, w_i) \leq 2$ , for each  $i = 1, 2$  and hence  $S$  is not 2-metric basis. Thus if  $|V| = 5$ , then  $G$  must be a path.

Conversely, it is easy to verify that each the graphs  $P_3, P_4, P_5$  and  $C_3$  has its 2-metric dimension 2. This completes the proof. □

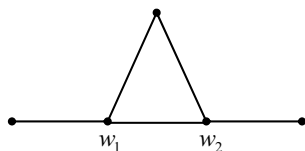

**Figure 3** Graph with  $\beta_2(G) = 2$

**Theorem 4.2** *For any integer  $k \geq 3$ ,  $\beta_k(G) = k$  if and only if  $G$  is a connected graph on  $k + 1$  vertices or  $G \cong P_{k+2}$ .*

*Proof* Let  $S_k$  be a  $k$ -metric basis for  $G$  with  $|S_k| = k$ . Then, by Theorem 3.1, we get

$$k + 1 \leq n \leq k \left( \frac{k}{k-1} \right) + 1 = \frac{(k+2)(k-1) + 1}{k-1} = (k+2) + \frac{1}{k-1} \Rightarrow k + 1 \leq n \leq k + 2$$

(since  $k \geq 3$ ) and hence  $|V - S_k| \leq 2$ .

**Case 1.**  $|V - S_k| = 2$ .

Let  $V - S_k = \{x, y\}$ .  $w \in S_k$  resolves  $x$  and  $y$ , and  $x_1 \in S_k$  is adjacent to  $x$ . Then the only two possibilities are that (i)  $x_1 = w$  and  $d(y, w) = k + 1$  or (ii)  $x_1 \neq w$  and  $y$  is adjacent to  $w$  (since  $|S_k| = k$  and  $d(x, y) \geq k$ ). So, the graph in this case is  $P_{k+2}$ .

**Case 2.**  $|V - S_k| = 1$

In this case,  $|V(G)| = k + 1$  and hence  $\text{diam}(G) \leq k$ . Thus, by Theorem 2.10, it follows that  $G$  is any connected graph on  $k + 1$  vertices for  $\beta_k(G) = k$ .

Conversely for a connected graph on  $k + 1$  vertices we have  $\text{diam}(G) \leq k$  and hence by Theorem 2.10,  $\beta_k(G) = (k + 1) - 1 = k$ . Further, for any path on  $P_{k+2}$  vertices and any  $k$ -resolving set  $S_k$  of  $P_{k+2}$ , the distance between any two vertices in  $V - S_k$  is at least  $k$ , which implies that,  $|V - S_k| \leq 2$ . Hence  $|S_k| \geq k$ .

Let  $\{v_1, v_2, \dots, v_k, v_{k+1}, v_{k+2}\}$  be the vertices of the path  $P_{k+2}$  such that  $v_i$  is adjacent to only  $v_{i+1}$  for each  $i, 1 \leq i \leq k + 1$ . Consider the set  $S_k = \{v_2, v_3, \dots, v_k, v_{k+2}\}$ .  $v_1, v_{k+1}$  are the only vertices in  $V - S_k$  that are  $k$ -resolved by the vertex  $v_{k+2}$  in  $S_k$ . Hence  $S_k$  is a  $k$ -resolving set with  $|S_k| = k$ . Therefore  $\beta_k(P_{k+2}) = k$ .  $\square$

**Problem 4.3** Solve for  $G$ , the equation  $\beta_k(G) = k + 1$  for all  $k \leq \text{diam}(G)$ .

### Acknowledgment

The authors are indebted to the learned referees for their valuable suggestions and comments. They are very much thankful to the Principals, Prof. C.Nanjundaswamy, Dr. Ambedkar Institute of Technology, Bengaluru, Prof. Jnanesh N.A., K.V.G. College of Engineering, Sullia and Prof. H. Y. Eswara, University College of Science, Tumakuru for their constant support and encouragement during the preparation of this paper.

### References

- [1] F. Buckley and F. Harary, *Distance in Graphs*, Addison-Wesley, 1990.
- [2] R. C. Brigham, G. Chartrand, R. D. Dutton and P. Zhang, Resolving domination in graphs, *Math. Bohem.*, 128(1), 25-36, 2003.
- [3] D. G. Cantor, Determining a set from the cardinalities of its intersections with other sets, *Canad. J. Math.*, 16:94-97, 1964.
- [4] D. G. Cantor and W. H. Mills, Determination of a subset from certain combinatorial properties, *Canad. J. Math.*, 18:42-48, 1966.
- [5] G. Chartrand, L. Eroh, M. A. Johnson, and O. R. Oellermann. Resolvability in graphs and the metric dimension of a graph, *Discrete Appl. Math.*, 105(1-3): 99-113, 2000.

- [6] G. Chartrand, D. Erwin, F. Harary and P. Zhang, Radio antipodal colorings of cycles, *Congr. Numer.*, 144: 129-141, 2000.
- [7] G. Chartrand and P. Zhang, The theory and applications of resolvability in graphs, A survey, In *Proc. 34th Southeastern International Conf. on Combinatorics, Graph Theory and Computing*, Vol. 160 of Congr. Numer.: 47-68, 2003.
- [8] R. K. Guy and R. J. Nowakowski, Coin-weighing problems, *Amer. Math. Monthly*, 102(2): 164,1995.
- [9] J. Cáceres, M. L. Puertas, C. Hernando, M. Mora, I. M. Pelayo, C. Seara and D. R. Wood, *On the metric dimension of cartesian products of graphs* <http://www.arxiv.org/math/0507527>: 1-23,2005.
- [10] H. Gerhard and Ringel, *Pearls in Graph Theory*, Academic Press, USA, 1994.
- [11] F. Harary and R. A. Melter, On the metric dimension of a graph, *Ars Combinatoria*, 2: 191-195, 1976.
- [12] C. Hernando, M. Mora, I. M. Pelayo and C. Seara, Extremal graph theory for metric dimension and diameter, *The Electronic Journal of Combinatorics*, 17, 2010.
- [13] S. Khuller, B. Raghavachari and A. Rosenfeld, Landmarks in graphs, *Disc. Appl. Math.*, 70: 217-229, 1996.
- [14] J. Liu and K. Williams, On bandwidth and edge sum for the composition of two graphs, *Disc. Math.*, 143: 159-166, 1995.
- [15] P. J. Slater, Leaves of trees, In *Proc. 6th Southeastern Conf. on Combinatorics, Graph Theory, and Computing*, Vol. 14 of Congressus Numerantium: 549-559, 1975.
- [16] P. J. Slater, Dominating and reference sets in a graph, *J. Math. Phys. Sci.*, 22(4): 445-455, 1988.
- [17] B. Shanmukha, B. Sooryanarayana, K. S. Harinath, Metric dimension of wheels, *Fareast J. Appl. Math.*, 8(3): 217-229, 2002.
- [18] V. Saenpholphat and P. Zhang, On connected resolving decompositions in graphs, *Czechoslovak Math. J.*, 54(129)(3): 681-696, 2004.
- [19] V. Saenpholphat and P. Zhang, Connected resolvability of graphs, *Czechoslovak Math. J.*, 53(128)(4): 827-840, 2003.
- [20] K. Shreedhar, B. Sooryanarayana, C. Hegde and M. Vishukumar, Metric dimension of Hexagonal Cellular Networks, *Int. J. of Math. Sci. and Engg. Applications*, 4(XI): 133-148, 2010.
- [21] B. Sooryanarayana, On the metric dimension of graph, *Indian J. Pure Appl. Math.*, 29(4): 413 - 415, 1998.
- [22] B. Sooryanarayana, *k*-metric dimension of a graph, *SIAM Conference of Discrete Mathematics*, Dalhousie University, Halifax, Canada: 45, 2012.
- [23] B. Sooryanarayana and B. Shanmukha, A note on metric dimension, *Far East J. Appl. Math.*, 5(3): 331-339, 2001.
- [24] B. Sooryanarayana and K. N. Geetha, On the k-metric dimension of graphs, *Journal of Mathematical and Computational Science*, 4(5): 861-878, 2014.
- [25] B. Sooryanarayana, K. Shreedhar and N. Narahari, On the metric dimension of the total graph of a graph, *Notes on Number Theory and Discrete Mathematics*, 22(4): 82-95, 2016.

## Radial Signed Graphs

P.Siva Kota Reddy

(Department of Mathematics, Siddaganga Institute of Technology, B.H.Road, Tumkur-572 103, India)

E-mail: reddy\_math@yahoo.com; pskreddy@sit.ac.in

**Abstract:** In this paper we introduced a new notion radial signed graph of a signed graph and its properties are obtained. Also, we obtained the structural characterization of radial signed graphs. Further, we presented some switching equivalent characterizations.

**Key Words:** Signed graphs, balance, switching, radial signed graph, negation of a signed graph.

**AMS(2010):** 05C12, 05C22

### §1. Introduction

For standard terminology and notation in graph theory we refer Harary [4] and Zaslavsky [40] for signed graphs. Throughout the text, we consider finite, undirected graph with no loops or multiple edges.

Within the rapid growth of the Internet and the Web, and in the ease with which global communication now takes place, connectedness took an important place in modern society. Global phenomena, involving social networks, incentives and the behavior of people based on the links that connect us appear in a regular manner. Motivated by these developments, there is a growing multidisciplinary interest to understand how highly connected systems operate [3].

In social sciences we often deal with relations of opposite content, e.g., “love”- “hatred”, “likes”-“dislikes”, “tells truth to”-“lies to” etc. In common use opposite relations are termed positive and negative relations. A signed graph is one in which relations between entities may be of various types in contrast to an unsigned graph where all relations are of the same type. In signed graphs edge-coloring provides an elegant and uniform representation of the various types of relations where every type of relation is represented by a distinct color.

In the case where precisely one relation and its opposite are under consideration, then instead of two colors, the signs + and - are assigned to the edges of the corresponding graph in order to distinguish a relation from its opposite. In the case where precisely one relation and its opposite are under consideration, then instead of two colors, the signs + and - are assigned to the edges of the corresponding graph in order to distinguish a relation from its opposite. Formally, a signed graph  $\Sigma = (\Gamma, \sigma) = (V, E, \sigma)$  is a graph  $\Gamma$  together with a function that assigns a sign  $\sigma(e) \in \{+, -\}$ , to each edge in  $\Gamma$ .  $\sigma$  is called the signature or sign function. In such a signed graph, a subset  $A$  of  $E(\Gamma)$  is said to be positive if it contains an even number

---

<sup>1</sup>Received June 6, 2016, Accepted November 20, 2016.

of negative edges, otherwise is said to be negative. Balance or imbalance is the fundamental property of a signed graph. A signed graph  $\Sigma$  is balanced if each cycle of  $\Sigma$  is positive. Otherwise it is unbalanced.

Signed graphs  $\Sigma_1$  and  $\Sigma_2$  are isomorphic, written  $\Sigma_1 \cong \Sigma_2$ , if there is an isomorphism between their underlying graphs that preserves the signs of edges.

The theory of balance goes back to Heider [7] who asserted that a social system is balanced if there is no tension and that unbalanced social structures exhibit a tension resulting in a tendency to change in the direction of balance. Since this first work of Heider, the notion of balance has been extensively studied by many mathematicians and psychologists. In 1956, Cartwright and Harary [2] provided a mathematical model for balance through graphs.

A *marking* of  $\Sigma$  is a function  $\zeta : V(\Gamma) \rightarrow \{+, -\}$ . Given a signed graph  $\Sigma$  one can easily define a marking  $\zeta$  of  $\Sigma$  as follows: For any vertex  $v \in V(\Sigma)$ ,

$$\zeta(v) = \prod_{uv \in E(\Sigma)} \sigma(uv),$$

the marking  $\zeta$  of  $\Sigma$  is called *canonical marking* of  $\Sigma$ .

The following are the fundamental results about balance, the second being a more advanced form of the first. Note that in a bipartition of a set,  $V = V_1 \cup V_2$ , the disjoint subsets may be empty.

**Theorem 1.1** *A signed graph  $\Sigma$  is balanced if and only if either of the following equivalent conditions is satisfied:*

- (1)(Harary [5]) *Its vertex set has a bipartition  $V = V_1 \cup V_2$  such that every positive edge joins vertices in  $V_1$  or in  $V_2$ , and every negative edge joins a vertex in  $V_1$  and a vertex in  $V_2$ ;*
- (2)(Sampathkumar [13]) *There exists a marking  $\mu$  of its vertices such that each edge  $uv$  in  $\Gamma$  satisfies  $\sigma(uv) = \zeta(u)\zeta(v)$ .*

Let  $\Sigma = (\Gamma, \sigma)$  be a signed graph. *Complement* of  $\Sigma$  is a signed graph  $\bar{\Sigma} = (\bar{\Gamma}, \sigma')$ , where for any edge  $e = uv \in \bar{\Gamma}$ ,  $\sigma'(uv) = \zeta(u)\zeta(v)$ . Clearly,  $\bar{\Sigma}$  as defined here is a balanced signed graph due to Theorem 1.1. For more new notions on signed graphs refer the papers (see [10-37]).

A switching function for  $\Sigma$  is a function  $\zeta : V \rightarrow \{+, -\}$ . The switched signature is  $\sigma^\zeta(e) := \zeta(v)\sigma(e)\zeta(w)$ , where  $e$  has end points  $v, w$ . The switched signed graph is  $\Sigma^\zeta := (\Sigma | \sigma^\zeta)$ . We say that  $\Sigma$  switched by  $\zeta$ . Note that  $\Sigma^\zeta = \Sigma^{-\zeta}$  (see [1]).

If  $X \subseteq V$ , switching  $\Sigma$  by  $X$  (or simply switching  $X$ ) means reversing the sign of every edge in the cut set  $E(X, X^c)$ . The switched signed graph is  $\Sigma^X$ . This is the same as  $\Sigma^\zeta$  where  $\zeta(v) := -$  if and only if  $v \in X$ . Switching by  $\zeta$  or  $X$  is the same operation with different notation. Note that  $\Sigma^X = \Sigma^{X^c}$ .

Signed graphs  $\Sigma_1$  and  $\Sigma_2$  are switching equivalent, written  $\Sigma_1 \sim \Sigma_2$  if they have the same underlying graph and there exists a switching function  $\zeta$  such that  $\Sigma_1^\zeta \cong \Sigma_2$ . The equivalence class of  $\Sigma$ ,

$$[\Sigma] := \{\Sigma' : \Sigma' \sim \Sigma\},$$

is called the its switching class.

Similarly,  $\Sigma_1$  and  $\Sigma_2$  are switching isomorphic, written  $\Sigma_1 \cong \Sigma_2$ , if  $\Sigma_1$  is isomorphic to a switching of  $\Sigma_2$ . The equivalence class of  $\Sigma$  is called its switching isomorphism class.

Two signed graphs  $\Sigma_1 = (\Gamma_1, \sigma_1)$  and  $\Sigma_2 = (\Gamma_2, \sigma_2)$  are said to be *weakly isomorphic* (see [?]) or *cycle isomorphic* (see [?]) if there exists an isomorphism  $\phi : \Gamma_1 \rightarrow \Gamma_2$  such that the sign of every cycle  $Z$  in  $\Sigma_1$  equals to the sign of  $\phi(Z)$  in  $\Sigma_2$ . The following result is well known.

**Theorem 1.2**(T. Zaslavsky [39]) *Two signed graphs  $\Sigma_1$  and  $\Sigma_2$  with the same underlying graph are switching equivalent if and only if they are cycle isomorphic.*

In [16], the authors introduced the switching and cycle isomorphism for signed digraphs.

In this paper, we initiate a study of the *radial signed graph* of a given signed graph and solve some important signed graph equations and equivalences involving it. Further, we obtained the structural characterization of radial signed graphs.

## §2. Radial Signed Graph of a Signed Graph

In a graph  $\Gamma$ , the distance  $d(u, v)$  between a pair of vertices  $u$  and  $v$  is the length of a shortest path joining them. The eccentricity  $e(u)$  of a vertex  $u$  is the distance to a vertex farthest from  $u$ . The radius  $r(\Gamma)$  of  $\Gamma$  is defined by  $r(\Gamma) = \min\{e(u) : u \in \Gamma\}$  and the diameter  $d(\Gamma)$  of  $\Gamma$  is defined by  $d(\Gamma) = \max\{e(u) : u \in \Gamma\}$ . A graph for which  $r(\Gamma) = d(\Gamma)$  is called a *self-centered graph* of radius  $r(\Gamma)$ . A vertex  $v$  is called an eccentric vertex of a vertex  $u$  if  $d(u, v) = e(u)$ . A vertex  $v$  of  $\Gamma$  is called an eccentric vertex of  $\Gamma$  if it is an eccentric vertex of some vertex of  $\Gamma$ . Let  $S_i$  denote the subset of vertices of  $\Gamma$  whose eccentricity is equal to  $i$ .

Kathiresan and Marimuthu [8] introduced a new type of graph called radial graph. Two vertices of a graph  $\Gamma$  are said to be radial to each other if the distance between them is equal to the radius of the graph. The radial graph of a graph  $\Gamma$ , denoted by  $R(\Gamma)$ , has the vertex set as in  $\Gamma$  and two vertices are adjacent in  $R(\Gamma)$  if, and only if, they are radial in  $\Gamma$ . If  $\Gamma$  is disconnected, then two vertices are adjacent in  $R(\Gamma)$  if they belong to different components of  $\Gamma$ . A graph  $\Gamma$  is called a *radial graph* if  $R(\Gamma) = \Gamma$  for some graph  $\Gamma'$ .

Motivated by the existing definition of complement of a signed graph, we now extend the notion of radial graphs to signed graphs as follows: The *radial signed graph*  $R(\Sigma)$  of a signed graph  $\Sigma = (\Gamma, \sigma)$  is a signed graph whose underlying graph is  $R(\Gamma)$  and sign of any edge  $uv$  is  $R(\Sigma)$  is  $\zeta(u)\zeta(v)$ , where  $\zeta$  is the canonical marking of  $\Sigma$ . Further, a signed graph  $\Sigma = (\Gamma, \sigma)$  is called radial signed graph, if  $\Sigma \cong R(\Sigma')$  for some signed graph  $\Sigma'$ . following result restricts the class of radial graphs.

**Theorem 2.1** *For any signed graph  $\Sigma = (\Gamma, \sigma)$ , its radial signed graph  $R(\Sigma)$  is balanced.*

*Proof* Since sign of any edge  $e = uv$  in  $R(\Sigma)$  is  $\zeta(u)\zeta(v)$ , where  $\zeta$  is the canonical marking of  $\Sigma$ , by Theorem 1.1,  $R(\Sigma)$  is balanced.  $\square$

For any positive integer  $k$ , the  $k^{th}$  iterated radial signed graph,  $R^k(\Sigma)$  of  $\Sigma$  is defined as follows:

$$R^0(\Sigma) = \Sigma, \quad R^k(\Sigma) = R(R^{k-1}(\Sigma)).$$

**Corollary 2.2** For any signed graph  $\Sigma = (\Gamma, \sigma)$  and for any positive integer  $k$ ,  $R^k(\Sigma)$  is balanced.

The following result characterizes signed graphs which are radial signed graphs.

**Theorem 2.3** A signed graph  $\Sigma = (\Gamma, \sigma)$  is a radial signed graph if, and only if,  $\Sigma$  is balanced signed graph and its underlying graph  $\Gamma$  is a radial graph.

*Proof* Suppose that  $\Sigma$  is balanced and  $\Gamma$  is a radial graph. Then there exists a graph  $\Gamma'$  such that  $R(\Gamma') \cong \Gamma$ . Since  $\Sigma$  is balanced, by Theorem 1, there exists a marking  $\zeta$  of  $\Gamma$  such that each edge  $uv$  in  $\Sigma$  satisfies  $\sigma(uv) = \zeta(u)\zeta(v)$ . Now consider the signed graph  $\Sigma' = (\Gamma', \sigma')$ , where for any edge  $e$  in  $\Gamma'$ ,  $\sigma'(e)$  is the marking of the corresponding vertex in  $\Gamma$ . Then clearly,  $R(\Sigma') \cong \Sigma$ . Hence  $\Sigma$  is a radial signed graph.

Conversely, suppose that  $\Sigma = (\Gamma, \sigma)$  is a radial signed graph. Then there exists a signed graph  $\Sigma' = (\Gamma', \sigma')$  such that  $R(\Sigma') \cong \Sigma$ . Hence,  $\Gamma$  is the radial graph of  $\Gamma'$  and by Theorem 3,  $\Sigma$  is balanced.  $\square$

The following result characterizes the signed graphs which are isomorphic to radial signed graphs. In case of graphs the following result is due to Kathiresan and Marimuthu [9].

**Theorem 2.4** Let  $\Gamma$  be a graph of order  $n$ . Then  $R(\Gamma) \cong \Gamma$  if, and only if,  $\Gamma$  is a connected graph with  $r(\Gamma) = d(\Gamma) = 1$  or  $r(\Gamma) = 1$  and  $d(\Gamma) = 2$ .

**Theorem 2.5** For any connected signed graph  $\Sigma = (\Gamma, \sigma)$ ,  $\Sigma \sim R(\Sigma)$  if, and only if,  $\Sigma$  is balanced and the underlying graph  $\Gamma$  with  $r(\Gamma) = d(\Gamma) = 1$  or  $r(\Gamma) = 1$  and  $d(\Gamma) = 2$ .

*Proof* Suppose  $R(\Sigma) \sim \Sigma$ . This implies,  $R(\Gamma) \cong \Gamma$  and hence by Theorem 2.4, we see that the graph  $\Gamma$  satisfies the conditions in Theorem 2.4. Now, if  $\Sigma$  is any signed graph with underlying graph being  $r(\Gamma) = d(\Gamma) = 1$  or  $r(\Gamma) = 1$  and  $d(\Gamma) = 2$ , Theorem 2.1 implies that  $R(\Sigma)$  is balanced and hence if  $\Sigma$  is unbalanced and its radial signed graph  $R(\Sigma)$  being balanced can not be switching equivalent to  $\Sigma$  in accordance with Theorem 1.2. Therefore,  $\Sigma$  must be balanced.

Conversely, suppose that  $\Sigma$  balanced signed graph with the underlying graph  $\Gamma$  with  $r(\Gamma) = d(\Gamma) = 1$  or  $r(\Gamma) = 1$  and  $d(\Gamma) = 2$ . Then, since  $R(\Sigma)$  is balanced as per Theorem 3 and since  $R(\Gamma) \cong \Gamma$  by Theorem 2.4, the result follows from Theorem 1.2 again.  $\square$

In [9], the authors characterize the graphs for which  $R(\Gamma) \cong \bar{\Gamma}$ .

**Theorem 2.6** Let  $\Gamma$  be a graph of order  $n$ . Then  $R(\Gamma) \cong \bar{\Gamma}$  if, and only if, either  $S_2(\Gamma) = V(\Gamma)$  or  $\Gamma$  is disconnected in which each component is complete.

In view of the above result, we have the following result that characterizes the family of signed graphs satisfies  $R(\Sigma) \sim \bar{\Sigma}$ .

**Theorem 2.7** For any signed graph  $\Sigma = (\Gamma, \sigma)$ ,  $R(\Sigma) \sim \bar{\Sigma}$  if, and only if, either  $S_2(\Gamma) = V(\Gamma)$  or  $\Gamma$  is disconnected in which each component is complete.



*Proof* Suppose that  $R(\Sigma) \sim \bar{\Sigma}$ . Then clearly,  $R(\Gamma) \cong \bar{\Gamma}$ . Hence by Theorem 2.6,  $\Gamma$  is either  $S_2(\Gamma) = V(\Gamma)$  or disconnected in which each component is complete.

Conversely, suppose that  $\Sigma$  is a signed graph whose underlying graph is either  $S_2(\Gamma) = V(\Gamma)$  or  $\Gamma$  is disconnected in which each component is complete. Then by Theorem 2.6,  $R(\Gamma) \cong \bar{\Gamma}$ . Since for any signed graph  $\Sigma$ , both  $R(\Sigma)$  and  $\bar{\Sigma}$  are balanced, the result follows by Theorem 1.2.  $\square$

The following result due to Kathiresan and Marimuthu [9] gives a characterization of graphs for which  $R(\Gamma) \sim R(\bar{\Gamma})$ .

**Theorem 2.8** *Let  $\Gamma$  be a graph. Then  $R(\Gamma) \sim R(\bar{\Gamma})$  if, and only if,  $\Gamma$  satisfies any one the following conditions:*

- (1)  $\Gamma$  or  $\bar{\Gamma}$  is complete;
- (2)  $\Gamma$  or  $\bar{\Gamma}$  is disconnected with each component complete out of which one is an isolated vertex.

We now give a characterization of signed graphs whose radial signed graphs are switching equivalent to their radial signed graph of complementary signed graphs.

**Theorem 2.9** *For any signed graph  $\Sigma = (\Gamma, \sigma)$ ,  $R(\Sigma) \sim R(\bar{\Sigma})$  if, and only if,  $\Gamma$  satisfies the conditions of Theorem 2.8.*

The notion of *negation*  $\eta(\Sigma)$  of a given signed graph  $\Sigma$  defined in [6] as follows:

$\eta(\Sigma)$  has the same underlying graph as that of  $\Sigma$  with the sign of each edge opposite to that given to it in  $\Sigma$ . However, this definition does not say anything about what to do with nonadjacent pairs of vertices in  $\Sigma$  while applying the unary operator  $\eta(\cdot)$  of taking the negation of  $\Sigma$ .

For a signed graph  $\Sigma = (\Gamma, \sigma)$ , the  $E_k(\Sigma)$  is balanced (Theorem 2.1). We now examine, the conditions under which negation  $\eta(\Sigma)$  of  $E_k(\Sigma)$  is balanced.

**Theorem 2.10** *Let  $\Sigma = (\Gamma, \sigma)$  be a signed graph. If  $R(\Gamma)$  is bipartite then  $\eta(R(\Sigma))$  is balanced.*

*Proof* Since, by Theorem 2.1,  $R(\Sigma)$  is balanced, if each cycle  $C$  in  $R(\Sigma)$  contains even number of negative edges. Also, since  $R(\Gamma)$  is bipartite, all cycles have even length; thus, the number of positive edges on any cycle  $C$  in  $R(\Sigma)$  is also even. Hence  $\eta(R(\Sigma))$  is balanced.  $\square$

## Acknowledgement

The author is thankful to the anonymous referee for valuable suggestions and comments for the improvement of the paper. Also, the author is grateful to Dr. M. N. Channabasappa, Director and Dr. Shivakumaraiah, Principal, Siddaganga Institute of Technology, Tumkur, for their constant support and encouragement.

## References

- [1] R. P. Abelson and M. J. Rosenberg, Symbolic psychologic: A model of attitudinal cognition, *Behav. Sci.*, 3 (1958), 1-13.
- [2] D. Cartwright and F. Harary, Structural Balance: A Generalization of Heiders Theory, *Psychological Review*, 63 (1956), 277-293.
- [3] David Easley and Jon Kleinberg, *Networks, Crowds, and Markets: Reasoning About a Highly Connected World*, Cambridge University Press, 2010.
- [4] F. Harary, *Graph Theory*, Addison-Wesley Publishing Co., 1969.
- [5] F. Harary, On the notion of balance of a signed graph, *Michigan Math. J.*, 2(1953), 143-146.
- [6] F. Harary, Structural duality, *Behav. Sci.*, 2(4) (1957), 255-265.
- [7] F. Heider, Attitudes and Cognitive Organisation, *Journal of Psychology*, 21 (1946), 107-112.
- [8] K. M. Kathiresan and G. Marimuthu, A study on radial graphs, *Ars Combin.* 96 (2010), 353-360.
- [9] K. M. Kathiresan and G. Marimuthu, Further results on radial graphs, *Discuss. Math. Graph Theory*, 30(1) (2010), 75-83.
- [10] R. Rangarajan and P. Siva Kota Reddy, The edge  $C_4$  signed graph of a signed graph, *Southeast Asian Bull. Math.*, 34(6) (2010), 1077-1082.
- [11] R. Rangarajan, M. S. Subramanya and P. Siva Kota Reddy, The  $H$ -Line Signed Graph of a Signed Graph, *International J. Math. Combin.*, 2 (2010), 37-43.
- [12] R. Rangarajan, M.S. Subramanya and P. Siva Kota Reddy, Neighborhood signed graphs, *Southeast Asian Bull. Math.*, 36(3) (2012), 389-397.
- [13] E. Sampathkumar, Point signed and line signed graphs, *Nat. Acad. Sci. Letters*, 7(3) (1984), 91-93.
- [14] E. Sampathkumar, P. Siva Kota Reddy and M. S. Subramanya, Directionally  $n$ -signed graphs, *Ramanujan Math. Soc., Lecture Notes Series (Proc. Int. Conf. ICDM 2008)*, 13 (2010), 155-162.
- [15] E. Sampathkumar, P. Siva Kota Reddy and M. S. Subramanya, Directionally  $n$ -signed graphs-II, *International J. Math. Combin.*, 4 (2009), 89-98.
- [16] E. Sampathkumar, M. S. Subramanya and P. Siva Kota Reddy, Characterization of line sidigraphs, *Southeast Asian Bull. Math.*, 35(2) (2011), 297-304.
- [17] P. Siva Kota Reddy and M. S. Subramanya, Signed graph equation  $L^k(S) \sim \overline{S}$ , *International J. Math. Combin.*, 4 (2009), 84-88.
- [18] P. Siva Kota Reddy and M. S. Subramanya, Note on path signed graphs, *Notes on Number Theory and Discrete Mathematics*, 15(4) (2009), 1-6.
- [19] P. Siva Kota Reddy, S. Vijay and V. Lokesha,  $n^{th}$  Power signed graphs, *Proceedings of the Jangjeon Math. Soc.*, 12(3) (2009), 307-313.
- [20] P. Siva Kota Reddy, S. Vijay and H. C. Savithri, A Note on Path Sidigraphs, *International J. Math. Combin.*, 1 (2010), 42-46.
- [21] P. Siva Kota Reddy, S. Vijay and V. Lokesha,  $n^{th}$  Power signed graphs-II, *International J. Math. Combin.*, 1 (2010), 74-79.

- [22] P. Siva Kota Reddy and S. Vijay, Total minimal dominating signed graph, *International J. Math. Combin.*, 3 (2010), 11-16.
- [23] P. Siva Kota Reddy and K. V. Madhusudhan, Negation switching equivalence in signed graphs, *International J. Math. Combin.*, 3 (2010), 85-90.
- [24] P. Siva Kota Reddy,  $t$ -Path Sigraphs, *Tamsui Oxford J. of Math. Sciences*, 26(4) (2010), 433-441.
- [25] P. Siva Kota Reddy, E. Sampathkumar and M. S. Subramanya, Common-edge signed graph of a signed graph, *J. Indones. Math. Soc.*, 16(2) (2010), 105-112.
- [26] P. Siva Kota Reddy, B. Prashanth, and T. R. Vasanth Kumar, Antipodal signed directed Graphs, *Advn. Stud. Contemp. Math.*, 21(4) (2011), 355-360.
- [27] P. Siva Kota Reddy, B. Prashanth and Kavita. S. Permi, A Note on Antipodal Signed Graphs, *International J. Math. Combin.*, 1 (2011), 107-112.
- [28] P. Siva Kota Reddy, V. Lokesha, B. Prashanth and S. Vijay, Some properties on Super Line Signed Graph  $\mathcal{L}_3(S)$ , *Journal of Analysis & Computation*, 7(1) (2011), 45-48.
- [29] P. Siva Kota Reddy and B. Prashanth,  $\mathcal{S}$ -Antipodal Signed Graphs, *Tamsui Oxf. J. Inf. Math. Sci.*, 28(2) (2012), 165-174.
- [30] P. Siva Kota Reddy and S. Vijay, The super line signed graph  $\mathcal{L}_r(S)$  of a signed graph, *Southeast Asian Bull. Math.*, 36(6) (2012), 875-882.
- [31] P. Siva Kota Reddy and B. Prashanth, The Common Minimal Dominating Signed Graph, *Trans. Comb.*, 1(3) (2012), 39-46.
- [32] P. Siva Kota Reddy and U. K. Misra, Common Minimal Equitable Dominating Signed Graphs, *Notes on Number Theory and Discrete Mathematics*, 18(4) (2012), 40-46.
- [33] P. Siva Kota Reddy and U. K. Misra, The Equitable Associate Signed Graphs, *Bull. Int. Math. Virtual Inst.*, 3(1) (2013), 15-20.
- [34] P. Siva Kota Reddy, K. R. Rajanna and Kavita S Permi, The Common Minimal Common Neighborhood Dominating Signed Graphs, *Trans. Comb.*, 2(1) (2013), 1-8.
- [35] P. Siva Kota Reddy, S. Vijay and Kavita S Permi, Note on Equitable Signed Graphs, *Mathematica Aeterna*, 3(3) 2013, 169-177.
- [36] P. Siva Kota Reddy and U. K. Misra, Graphoidal Signed Graphs, *Advn. Stud. Contemp. Math.*, 23(3) (2013), 451-460.
- [37] P. Siva Kota Reddy and U. K. Misra, Directionally  $n$ -signed graphs-III: The notion of symmetric balance, *Trans. Comb.*, 2(4) (2013), 53-62.
- [38] T. Sozánky, Enumeration of weak isomorphism classes of signed graphs, *J. Graph Theory*, 4(2)(1980), 127-144.
- [39] T. Zaslavsky, Signed graphs, *Discrete Appl. Math.*, 4(1)(1982), 47-74.
- [40] T. Zaslavsky, A mathematical bibliography of signed and gain graphs and its allied areas, *Electronic J. Combin.*, 8(1)(1998), Dynamic Surveys (1999), No. DS8.

## The Geodesic Irredundant Sets in Graphs

S.V.Ullas Chandran

Department of Mathematics, Mahatma Gandhi College  
Kesavadasapuram, Pattom P.O., Thiruvananthapuram - 695 004, India

G.Jaya Parthasarathy

Department of Mathematics, St. Jude's College, Thoothoor, Tamil Nadu - 629176, India

E-mail: svuc.math@gmail.com; jparthasarathy1234@gmail.com

**Abstract:** For two vertices  $u$  and  $v$  of a connected graph  $G$ , the set  $I[u, v]$  consists of all those vertices lying on  $u - v$  geodesics in  $G$ . Given a set  $S$  of vertices of  $G$ , the union of all sets  $I[u, v]$  for  $u, v \in S$  is denoted by  $I[S]$ . A convex set  $S$  satisfies  $I[S] = S$ . The convex hull  $[S]$  of  $S$  is the smallest convex set containing  $S$ . The hull number  $h(G)$  is the minimum cardinality among the subsets  $S$  of  $V$  with  $[S] = V$ . In this paper, we introduce and study the geodesic irredundant number of a graph. A set  $S$  of vertices of  $G$  is a geodesic irredundant set if  $u \notin I[S - \{u\}]$  for all  $u \in S$  and the maximum cardinality of a geodesic irredundant set is its irredundant number  $gir(G)$  of  $G$ . We determine the irredundant number of certain standard classes of graphs. Certain general properties of these concepts are studied. We characterize the classes of graphs of order  $n$  for which  $gir(G) = 2$  or  $gir(G) = n$  or  $gir(G) = n - 1$ , respectively. We prove that for any integers  $a$  and  $b$  with  $2 \leq a \leq b$ , there exists a connected graph  $G$  such that  $h(G) = a$  and  $gir(G) = b$ . A graph  $H$  is called a maximum irredundant subgraph if there exists a graph  $G$  containing  $H$  as induced subgraph such that  $V(H)$  is a maximum irredundant set in  $G$ . We characterize the class of maximum irredundant subgraphs.

**Key Words:** Interior vertex, extreme vertex, hull number, geodesic irredundant sets, irredundant number.

**AMS(2010):** 05C12

### §1. Introduction

By a graph  $G = (V, E)$  we mean a finite undirected connected graph without loops or multiple edges. The distance  $d(u, v)$  between two vertices  $u$  and  $v$  in a connected graph  $G$  is the length of a shortest  $u - v$  path in  $G$ . An  $u - v$  path of length  $d(u, v)$  is called an  $u - v$  geodesic. It is known that the distance is a metric on the vertex set  $V$ . The set  $I[u, v]$  consists of all vertices lying on some  $u - v$  geodesic of  $G$ , while for  $S \subseteq V$ ,  $I[S] = \bigcup_{u, v \in S} I[u, v]$ . The set  $S$  is convex if  $I[S] = S$ . The convex hull  $[S]$  is the smallest convex containing  $S$ . The convex hull  $[S]$

---

<sup>1</sup>Received April 12, 2016, Accepted November 22, 2016.

can also be formed from the sequence  $\{I^k[S]\}$ ,  $k \geq 0$ , where  $I^0[S] = S$ ,  $I^1[S] = I[S]$  and  $I^k[S] = I[I^{k-1}[S]]$  for  $k \geq 2$ . From some term on, this sequence must be constant. Let  $p$  be the smallest number such that  $I^p[S] = I^{p+1}[S]$ . Then  $I^p[S]$  is the convex hull  $[S]$ . A set  $S$  of vertices of  $G$  is a *hull set* of  $G$  if  $[S] = V$ , and a hull set of minimum cardinality is a *minimum hull set* or *h-set* of  $G$ . The cardinality of a minimum hull set of  $G$  is the *hull number*  $h(G)$  of  $G$ . To illustrate these concepts, consider the graph  $G$  in Figure 1.1 and the set  $S = \{s, t, y\}$ . Since  $I[S] = \{s, t, u, v, w, x, y\}$  and  $I^2[S] = V$ , it follows that  $S$  is a hull set of  $G$ . In fact,  $S$  is a minimum hull set and so  $h(G) = 3$ .

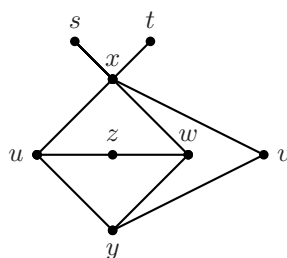

Figure 1.1

A vertex  $x$  is an *extreme vertex* of  $G$  if the induced subgraph of the neighbors of  $x$  is complete or equivalently,  $V - \{x\}$  is convex in  $G$ . The hull number is an important graph parameter. The hull number of a graph was introduced by Everett and Seidman [7] and further studied in [2, 3, 4, 5, 8].

These concepts have many applications in location theory and convexity theory. There are interesting applications of these concepts to the problem of designing the route for a shuttle and communication network design. For basic graph theoretic terminology, we refer to [6]. We also refer to [1] for results on distance in graphs.

If  $S$  is hull set of a connected graph  $G$  and  $u, v \in S$ , then each vertex of every  $u - v$  geodesic of  $G$  belongs to  $I[S]$ . This gives the following observation.

**Observation 1.1**([3]) *Let  $S$  be a h-set of a connected graph  $G$  and let  $u, v \in S$ . If  $w \neq (u, v)$  lies on a  $u - v$  geodesic in  $G$ , then  $w \notin S$ .*

The above observation motivate us to study a new type of sets, called geodesic irredundant sets, which generalizes minimum hull sets in a graph. In the next section, we introduce and study geodesic irredundant sets and the irredundant number of a graph. The irredundant number of certain standard classes of graphs are determined. Various characterization results are proved.

**Theorem 1.2**([3]) *For integers  $m, n \geq 2$ ,  $h(K_{m,n}) = 2$ .*

**Theorem 1.3**([3]) *Each extreme vertex of a connected graph  $G$  belongs to every hull set of  $G$ . In particular, if the set  $S$  of all extreme vertices is a hull set of  $G$ , then  $S$  is the unique h-set of  $G$ .*

## §2. Geodesic Irredundant Sets in Graphs

Let  $S$  be a set of vertices in a connected graph  $G$ . A vertex  $v$  in  $S$  is called an *interior vertex* of  $S$ , if  $v \in I[S - \{v\}]$ . The set of all interior vertices of  $S$  is denoted by  $S^0$ . It can be observe that if  $S^0 = \emptyset$ , then  $T^0 = \emptyset$  for any subset  $T$  of  $S$ . A set  $S$  of vertices is called a *geodesic irredundant set* or simply *irredundant set* if  $S^0 = \emptyset$ . An irredundant set of maximum cardinality is called a *maximum irredundant set* or a *gir - set* of  $G$ . The cardinality of a *gir - set* is the *irredundant number*  $gir(G)$  of  $G$ . It follows from Observation 1.1 that every minimum hull set of a connected graph  $G$  is an irredundant set in  $G$  and so we have that  $2 \leq h(G) \leq gir(G) \leq n$ , where  $n$  is the order of  $G$ . To illustrate these concepts, consider the graph  $G$  in Figure 2.1. Let  $S = \{v_2, v_3, v_5\}$ . Then it is clear that  $S^0 = \emptyset$  and so  $S$  is an irredundant set. It can be easily verified that any set with four or more vertices is not an irredundant set of  $G$  and so  $gir(G) = |S| = 3$ . On the other hand, let  $S' = \{v_1, v_4\}$ . Then  $I[S'] = V$  and so we have that  $h(G) = 2$ . Since the irredundant number of a disconnected graph is the sum of the irredundant numbers of its components, we are only concerned with connected graphs. One can note that for each integer  $n$ , there is only one connected graph of order  $n$  having the largest possible irredundant number, namely  $n$ , and this is the complete graph  $K_n$ .

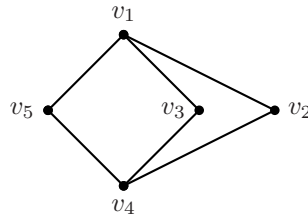

Figure 2.1

**Theorem 2.1** For a connected graph  $G$  of order  $n$ ,  $gir(G) = n$  if and only if  $G = K_n$ .

We determine the geodesic irredundant number of certain standard classes of graphs.

**Proposition 2.2** For integers  $m \geq n \geq 2$ ,  $gir(K_{m,n}) = m$ .

*Proof* It is clear that  $gir(K_{2,2}) = 2$  and so we can assume that  $m \geq 3$ . Let  $V_1$  and  $V_2$  be the partite sets of  $K_{m,n}$  with  $|V_1| = m$  and  $|V_2| = n$ . Then it is obvious that both  $V_1$  and  $V_2$  are irredundant sets of  $K_{m,n}$ . Now, let  $S$  be any set of cardinality greater than  $m$ . Then  $S \cap V_1 \neq \emptyset$  and  $S \cap V_2 \neq \emptyset$ . Since  $|S| \geq 3$ , it follows that either  $|S \cap V_1| \geq 2$  or  $|S \cap V_2| \geq 2$ . This shows that  $S^0 \neq \emptyset$  and hence  $gir(K_{m,n}) = |V_1| = m$ .  $\square$

**Proposition 2.3** For any cycle  $C_n$  ( $n \geq 5$ ),  $gir(C_n) = 3$ .

*Proof* Let  $S = \{x_1, x_2, \dots, x_k\}$  be any set of vertices in  $C_n$  of cardinality  $k \geq 4$ . We prove that  $S^0 \neq \emptyset$ . Assume the contrary that  $S^0 = \emptyset$ . Then we consider the following two cases.

**Case 1.**  $n$  is even. Now, let  $v$  be the antipodal vertex of  $x_1$ . If  $v \in S$  and since  $|S| \geq 4$ , it

follows that  $S^0 \neq \emptyset$ . So we can assume that  $v \notin S$ . Let  $P_1 : x_1 = u_1, u_2, \dots, u_{\frac{n}{2}+1} = v$  and  $P_2 : x_1 = v_1, v_2, \dots, v_{\frac{n}{2}+1} = v$  be the two  $x_1 - v$  geodesics in  $C_n$ . Since  $S^0 = \emptyset$ , without loss of generality we can assume that  $x_2 = u_r \in P_1$ ; and  $x_3 = v_s \in P_2$  and  $x_4 = u_t \in P_1$ . If  $t < r$ , then  $x_4 \in S^0$ ; and if  $t > r$ , then  $x_2 \in S^0$ . This is a contradiction. Thus  $S$  is not an irredundant set and hence  $\text{gir}(C_n) \leq 3$ . Now, since  $T = \{u_1, u_{\frac{n}{2}}, v_{\frac{n}{2}}\}$  is an irredundant set of cardinality 3, we have that  $\text{gir}(C_n) = 3$ .

**Case 2.**  $n$  is odd. Let  $x_1 \in S$  and let  $v, v'$  be the two antipodal vertices of  $x_1$ . Let  $P_1 : x_1 = u_1, u_2, \dots, u_{\frac{n+1}{2}} = v'$  and  $P_2 : x_1 = v_1, v_2, \dots, v_{\frac{n+1}{2}} = v$  be the  $x_1 - v'$  and  $x_1 - v$  geodesics in  $C_n$ , respectively. Since  $S$  is an irredundant set containing at least four vertices, it follows that either  $v \notin S$  or  $v' \notin S$ .

**Subcase 2.1**  $v \notin S$  and  $v' = x_2 \in S$ . Then it is clear that  $x_3, x_4 \notin P_1$  and so  $x_3, x_4 \in P_2$ . This implies that either  $x_3 \in S^0$  or  $x_4 \in S^0$ . This leads to a contradiction to the fact that  $S^0 = \emptyset$ .

**Subcase 2.2**  $v \notin S$  and  $v' \notin S$ . Now, since  $S^0 = \emptyset$ , we have that  $P_1$  contains at most one of  $x_2$  and  $x_3$ . Also,  $P_2$  contains at most one of  $x_2$  and  $x_3$ . Hence without loss of generality, we may assume that  $x_2 \in P_1$  and  $x_3 \in P_2$ . Now, since  $|S| \geq 4$ , as in Case 1, it follows that  $S^0 \neq \emptyset$ . This is impossible and hence  $\text{gir}(C_n) \leq 3$ . Now, since  $T = \{x_1, v, v'\}$  is an irredundant set of  $C_n$ , we have that  $\text{gir}(C_n) = 3$ .  $\square$

The irredundant number of a graph has certain properties that are also possessed by the hull number of a graph. In [6], it was shown that if  $G$  is a connected graph of order  $n \geq 2$  and diameter  $d$ , then  $h(G) \leq n - d + 1$ . The same result is also true for the irredundant number of a graph.

**Theorem 2.4** *Let  $G$  be a connected graph of order  $n$  and diameter  $d$ . Then  $\text{gir}(G) \leq n - d + 1$ .*

*Proof* Let  $S$  be any set of cardinality greater than  $n - d + 1$ . Let  $P : u_0, u_1, \dots, u_d = v$  be a diametral path in  $G$ . Since  $|S| > n - d + 1$ , it follows that  $S$  contains at least three vertices from the diametral path  $P$ , say,  $u_i, u_j$  and  $u_k$  with  $0 \leq i < j < k \leq d$ . This implies that  $u_j \in I[u_i, u_k]$  and so  $S^0 \neq \emptyset$ . Thus  $\text{gir}(G) \leq n - d + 1$ .  $\square$

We determine  $\text{gir}(T)$  for  $T$  a tree.

**Theorem 2.5** *For any tree  $T$  with  $k$  end vertices,  $\text{gir}(T) = k$ .*

*Proof* Let  $S$  be a  $\text{gir}$ -set of  $T$ . Suppose that the set  $S$  contains a cut vertex, say,  $v$  of  $T$ . Let  $C_1, C_2, \dots, C_l (l \geq 2)$  be the components of  $T - v$ . It is clear that each component  $C_i$  of  $T - v$  contains at least one end vertex, say,  $u_i$  of  $T$ . Since  $S$  is an irredundant set of  $T$  containing the cut vertex  $v$ , without loss of generality, we may assume that  $C_1 \cap S \neq \emptyset$  and  $C_i \cap S = \emptyset$  for all  $i = 2, 3, \dots, l$ . First, we prove that  $l = 2$ . Otherwise, if  $l \geq 3$ , then the set  $S' = (S - \{v\}) \cup \{u_2, u_3\}$  is an irredundant set in  $T$  with  $|S'| = \text{gir}(G) + 1$ . This is a contradiction. Hence  $l = 2$ . Now, let  $S_1 = (S - \{v\}) \cup \{u_2\}$ . Then  $S_1$  is an irredundant set of cardinality  $\text{gir}(G)$ . Moreover,  $S_1$  excludes the cut vertex  $v$  and includes a new end vertex  $u_2$ . We can continue this process until the resultant  $\text{gir}$ -set has no cut vertices. This is possible

only when  $S$  has  $k$  vertices or less. Now, since the set of all end vertices of  $T$  is an irredundant set, the result follows.  $\square$

A *caterpillar* is a tree of order 3 or more, the removal of whose end-vertices produces a path.

**Theorem 2.6** For any non trivial tree  $T$  of order  $n$  and diameter  $d$ ,  $gir(T) = n - d + 1$  if and only if  $T$  is a caterpillar.

*Proof* Let  $T$  be any non trivial tree. Let  $u, v$  be two vertices in  $T$  such that  $d(u, v) = d$ ; and let  $P : u = v_0, v_1, \dots, v_{d-1}, v_d = v$  be a diametral path. Let  $k$  be the number of end vertices of  $T$  and  $l$  the number of internal vertices of  $T$  other than  $v_1, v_2, \dots, v_{d-1}$ . Then  $d - 1 + l + k = n$ . By Theorem 2.5,  $gir(T) = k = n - d - l + 1$ . Hence  $gir(T) = n - d + 1$  if and only if  $l = 0$ , if and only if all the internal vertices of  $T$  lie on the diametral path  $P$ , if and only if  $T$  is a caterpillar.  $\square$

**Remark 2.7** Every minimum hull set of a connected graph  $G$  contains its extreme vertices. This is, in fact, true for non-minimum hull sets and follows directly from the fact that an extreme vertex  $v$  is either an initial or terminal vertex of any geodesic containing  $v$ . One might be led to believe that every maximum irredundant set of a graph  $G$  must contains its extreme vertices, but this is not so, as the graph  $G$  in Figure 2.2, the set  $S = \{u_1, u_2, u_3, u_4\}$  is the unique *gir*-set of  $G$ . Moreover, any irredundant set of  $G$  containing the extreme vertex  $u_5$  is of cardinality less than or equal to 3.

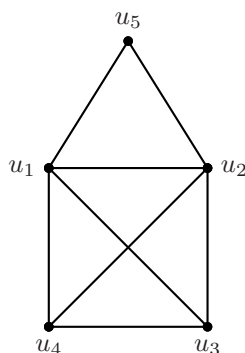

Figure 2.2

**Remark 2.8** In a connected graph  $G$ , cut vertices do not belong to any *h*-set of  $G$ . But cut vertices may belong to *gir*-sets of a graph. For the graph  $G$  in Figure 2.3, the set  $S = \{u_1, u_2, u_3\}$  is an *gir*-set containing the cut vertex  $u_1$ .

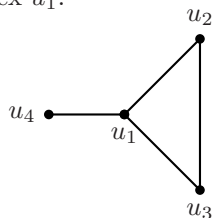

Figure 2.3



**Theorem 2.9** *In a connected graph  $G$ , a cut vertex  $v$  belongs to an  $gir$ -set in  $G$  if and only if  $G - v$  has exactly two components and at least one of them is  $K_1$ .*

*Proof* First, let  $S$  be an  $gir$ -set of  $G$  containing the cut vertex  $v$ . Suppose that  $G - v$  has three components, say  $C_1, C_2$  and  $C_3$ . Since  $S$  is an irredundant set containing the cut vertex  $v$ , it follows that  $S$  intersect with at most one of  $C_1, C_2$  and  $C_3$ . Assume without loss of generality that  $S \cap V(C_2) = \emptyset$  and  $S \cap V(C_3) = \emptyset$ . Choose vertices  $x$  and  $y$  in  $G$  such that  $x \in V(C_2)$  and  $y \in V(C_3)$ . Then it is obvious that the set  $T = (S - \{v\}) \cup \{x, y\}$  is an irredundant set in  $G$ . This is a contradiction to the maximality of  $S$ . Hence  $G - v$  has exactly two components, say  $C_1$  and  $C_2$ . Now, suppose that  $C_1 \neq K_1$  and  $C_2 \neq K_1$ . Then as above, we have that  $S \cap V(C_1) = \emptyset$  or  $S \cap V(C_2) = \emptyset$ . Since  $|S| \geq 2$ , we can assume that  $S \cap V(C_1) \neq \emptyset$  and  $S \cap V(C_2) = \emptyset$ . Let  $x$  and  $y$  be any two distinct vertices in  $C_2$ . Then the set  $T = (S - \{v\}) \cup \{x, y\}$  is an irredundant set in  $G$ , which is impossible. Hence either  $C_1 = K_1$  or  $C_2 = K_1$ . Conversely, suppose that  $G - v$  has exactly two components, say,  $C_1$  and  $C_2$  such that  $V(C_1) = \{u\}$ . Let  $S$  be any  $gir$ -set of  $G$ . Suppose that  $v \notin S$ . Since  $S$  is a maximum irredundant set and  $V(C_2)$  is convex in  $G$ , it follows that the vertex  $u$  belongs to  $S$ . This implies that the set  $T = (S - \{u\}) \cup \{v\}$  is an irredundant set of cardinality  $gir(G)$  containing the cut vertex  $v$ . Hence the result follows.  $\square$

Next theorem is a characterization of classes of graphs  $G$  for which  $gir(G) = 2$ . The length of a shortest cycle in a connected graph  $G$  is the girth of  $G$ , denoted by  $girth(G)$ .

**Theorem 2.10** *For a connected graph  $G$ ,  $gir(G) = 2$  if and only if  $G = P_n$  or  $G = C_4$ .*

*Proof* If  $G = P_n$  or  $G = C_4$ , then it follows from Theorem 2.5 and Proposition 2.2 that  $gir(G) = 2$ . Conversely, assume that  $gir(G) = 2$ . If  $G$  is acyclic, then it follows from Theorem 2.5 that  $G = P_n$ . So, assume that  $G$  contains cycles. First, we prove that  $girth(G) = 4$ . Suppose that  $girth(G) = r \geq 5$ . Let  $C : u_1, u_2, \dots, u_r, u_1$  be a shortest cycle in  $G$ . If  $r = 2n$ , then it clear that  $d(u_1, u_n) = n - 1$ ;  $d(u_1, u_{n+2}) = n - 1$  and  $d(u_n, u_{n+2}) = 2$ . Hence it follows that the set  $S = \{u_1, u_n, u_{n+2}\}$  is an irredundant set in  $G$ , which is a contradiction to the fact that  $gir(G) = 2$ . Similarly, if  $r = 2n + 1$ , then we have that  $d(u_1, u_{n+1}) = n$ ;  $d(u_1, u_{n+2}) = n$  and  $d(u_{n+1}, u_{n+2}) = 1$ . Hence it follows that the set  $S = \{u_1, u_{n+1}, u_{n+2}\}$  is an irredundant set, which is also impossible. This implies that  $girth(G) \leq 4$ . Now, if  $girth(G) = 3$ , then there exist three mutually adjacent vertices in  $G$ , say,  $u, v$  and  $w$  and so  $G$  has an irredundant set of cardinality 3. Therefore, we have that  $girth(G) = 4$ . Let  $C : u, v, w, x, u$  be a shortest cycle in  $G$ . If  $G \neq C$ , then without loss of generality, we can assume that there exists a vertex  $y$  in  $G$  such that  $y \notin V(C)$  and  $y$  is adjacent to  $u$  in  $G$ . Since  $girth(G) = 4$ , it follows that  $y$  is not adjacent to both  $x$  and  $v$ . This shows that the set  $T = \{x, y, v\}$  is an irredundant set in  $G$ , which leads to a contradiction. Hence we have that  $G = C_4$ .  $\square$

For any connected graph  $G$ , we have that  $2 \leq h(G) \leq gir(G)$ . The following theorem is a realization of this result.

**Theorem 2.11** *For every pair  $a, b$  of integers with  $2 \leq a \leq b$ , there exists a connected graph  $G$  such that  $h(G) = a$  and  $gir(G) = b$ .*

*Proof* If  $a = 2$ , then it follows from Theorem 1.2 and Proposition 2.2 that  $h(K_{2,b}) = 2$  and  $gir(K_{2,b}) = b$ . So, assume that  $a > 2$ . Let  $G$  be the graph obtained from the complete graph  $K_b$  with vertex set  $V(K_b) = \{x_1, x_2, \dots, x_b\}$  by adding new vertices  $u$  and  $v$ ; and the edges  $ux_i (1 \leq i \leq b - a + 2)$  and  $vx_i (1 \leq i \leq b - a + 2)$ . We first show that  $h(G) = a$ . Since the set  $S = \{u, v, x_{b-a+3}, x_{b-a+4}, \dots, x_b\}$  of all extreme vertices of  $G$  is a hull set of  $G$ , it follows directly from Theorem 1.3 that  $h(G) = |S| = a$ . Also, it is clear that the set  $T = \{x_1, x_2, \dots, x_b\}$  is an irredundant set and so  $gir(G) \geq |T| = b$ . Now, it follows from Theorems 2.1 and 3.1 that  $gir(G) = b$ .  $\square$

### §3. Maximum Irredundant Subgraphs

In this section, we present a characterization of graphs of order  $n$  having the irredundant number  $n - 1$ . By Theorem 2.5, the star  $K_{1,n-1}$  of order  $n \geq 3$ , which can also be expressed as  $K_1 + \overline{K_{n-1}}$ , has irredundant number  $n - 1$ . Our characterization of graphs of order  $n$  having the irredundant number  $n - 1$  shows that the class of stars can be generalized to produce all graphs having the irredundant number  $n - 1$ .

**Theorem 3.1** *Let  $G$  be a connected graph of order  $n$ . Then  $gir(G) = n - 1$  if and only if  $G = K_1 + \bigcup_j m_j K_j$  with  $\sum m_j \geq 2$  or  $G = K_n - \{e_1, e_2, \dots, e_k\}$  with  $1 \leq k \leq n - 3$ , where  $e_i$ 's all are edges in  $K_n$  which are incident to a common vertex  $v$ .*

*Proof* Suppose that  $G = K_1 + \bigcup_j m_j K_j$  and let  $v$  be the cut vertex of  $G$ . Then it is clear that  $V - \{v\}$  is an irredundant set in  $G$ . Also, if  $G = K_n - \{vx_1, vx_2, \dots, vx_k\}$ , then  $V - \{v\}$  is an irredundant set in  $G$ . Hence it follows from Theorem 2.1 that  $gir(G) = n - 1$ . Conversely, assume that  $gir(G) = n - 1$ , then it follows from Theorems 2.1 and 2.4 that  $diam(G) = 2$  and so  $G$  contains interior vertices. We consider the following two cases.

**Case 1.**  $G$  has a unique interior vertex, say  $v$ . Choose vertices  $u$  and  $w$  both are different from  $v$  such that  $v \in I[u, w]$ . In this case, we prove that  $G = K_1 + \bigcup_j m_j K_j$ . For, if  $G$  has no cut vertices, then the vertices  $u$  and  $w$  lie on a common cycle  $C$ ; and so there exist vertices  $x, y$  and  $z$  on the cycle  $C$  such that  $P : x, y, z$  is a geodesic of length 2 with  $y \neq v$ . This leads to a contradiction and hence  $G$  has cut vertices. Now, since every cut vertex of  $G$  is also an interior vertex, it follows that  $v$  is the only cut vertex in  $G$ . Since  $diam(G) = 2$  and  $v$  is the unique interior vertex in  $G$ , we have that the vertex  $v$  must be adjacent to every other vertices in  $G$ . Now, let  $C_1, C_2, \dots, C_k$  ( $k \geq 2$ ) be the components of  $G - v$ . We claim that each  $C_i$  is complete. Suppose there exists  $j$  with  $1 \leq j \leq k$  such that  $diam(C_j) \geq 2$ . Then there exists a geodesic  $Q : u_1, u_2, u_3$  in  $G$  with  $u_2 \neq v$ . This is a contradiction to the fact that  $v$  is the unique interior vertex in  $G$ . Hence each component of  $G - v$  is complete and so  $G = K_1 + \bigcup_j m_j K_j$ .

**Case 2.**  $G$  has at least two interior vertices. Let  $S$  be an irredundant set of cardinality  $n - 1$  and let  $V - S = \{v\}$ . We first claim that  $\langle S \rangle$  is complete. If not, assume that there exist vertices  $x$  and  $y$  in  $S$  which are not adjacent in  $G$ . Then  $d(x, y) = 2$ . Also, since  $S$  is an irredundant set of cardinality  $n - 1$ , we have that  $v$  is the only vertex adjacent to both  $x$  and  $y$  in  $G$ . Moreover, one can observe that if  $u_1$  and  $u_2$  are non-adjacent vertices in  $S$ , then the

vertex  $v$  is only vertex adjacent to both  $u_1$  and  $u_2$  in  $G$ . Now, Since  $G$  contains at least two interior vertices, it follows that there exist vertices  $u$  and  $z$  in  $G$  such that  $u \neq z$  and  $z \in I[u, v]$ . It follows from the above observation that the vertex  $u$  is adjacent to both  $x$  and  $y$ . Hence  $u \in S^0$ . This is a contradiction. Thus  $\langle S \rangle$  is complete. Now, since  $G$  is connected. By Theorem 2.1, we have that  $G = K_n - \{vx_1, vx_2, \dots, vx_k\}$ .  $\square$

We now introduce a concept that will turn out to be closely connected to the result already stated in this section. A graph  $H$  is called a *maximum irredundant subgraph*, if there exists a graph  $G$  containing  $H$  as an induced subgraph such that  $V(H)$  is a maximum irredundant set of  $G$ . For example, consider the graphs  $H$  and  $G$  in Figure 3.1. It follows from Theorems 2.1 and 3.1 that the irredundant set  $S = \{u, v, w\}$  is maximum in  $G$ , and  $H$  is an induced subgraph of  $G$ . Hence  $H$  is a maximum irredundant subgraph of the graph  $G$ . Also, by Theorem 3.1, for positive integers  $n_1, n_2, \dots, n_r$  with  $r \geq 1$ , the graph  $K_{n_1} \cup K_{n_2} \cup \dots \cup K_{n_r}$  is a maximum irredundant subgraph. The analog concepts of minimum hull subgraph was studied in [3]. A graph  $H$  is a minimum hull subgraph if there exists a graph  $G$  containing  $H$  as an induced subgraph such that  $V(H)$  is a minimum hull set of  $G$ . Next, we characterize the class of all maximum irredundant subgraphs.

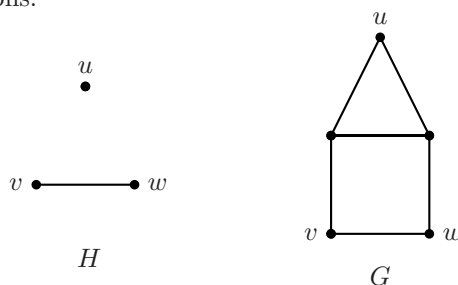

**Figure 3.1**  $G \& H$

**Theorem 3.2** *A non trivial graph  $H$  is a maximum irredundant subgraph of some connected graph if and only if every component of  $H$  is complete.*

*Proof* First, let  $H$  be a maximum irredundant subgraph of a connected graph  $G$ . Assume to the contrary, that  $H$  contains a component that is not complete. Then there exist  $u, v \in V(H)$  such that  $d_H(u, v) = 2$  and so  $H$  has at least one vertex, say,  $w$  different from both  $u$  and  $v$  such that  $w$  lies on some  $u - v$  geodesic in  $H$ . This is a contradiction to the fact that  $V(H)$  is an irredundant set in  $G$ . We now verify the converse. Let  $H$  be a graph such that every component of  $H$  is complete. If  $H$  is connected, then  $H$  is the maximum irredundant subgraph of  $H$  itself. Otherwise,  $H = K_{n_1} \cup K_{n_2} \cup \dots \cup K_{n_r}$  for positive integers  $n_1, n_2, \dots, n_r$ , where  $r \geq 2$ . Let  $G = K_1 + H$ . Then by Theorem 3.1,  $V(H)$  is a maximum irredundant set in  $G$ . This completes the proof.  $\square$

We leave the following problem as open.

**Problem 3.3** *Characterize the classes of graphs  $G$  for which  $gir(G) = h(G)$ .*

**References**

- [1] F. Buckley and F. Harary, *Distance in Graphs*, Addison-Wesley, Redwood City, CA, 1990.
- [2] G. B. Cagaanan and S.R. Canoy, Jr., On the hull sets and hull number of the composition graphs, *Ars Combin.*, 75(2005), 113-119.
- [3] G. Chartrand, F. Harary and P. Zhang, On the hull number of a graph, *Ars Combin.*, 57(2000), 129-138.
- [4] G. Chartrand and P. Zhang, On graphs with a unique minimum hull set, *Discuss. Math. Graph Theory*, 21(2001), 31-42.
- [5] G. Chartrand and P. Zhang, The forcing hull number of a graph, *J. Combin. Math. Combin. Comput.*, 36(2001), 81-94.
- [6] G. Chartrand and P. Zhang, *Introduction to Graph Theory*, Tata McGraw-Hill Edition, New Delhi, 2006.
- [7] M. G. Everett and S. B. Seidman, The hull number of a graph, *Discrete Math.*, 57(1985), 217-223.
- [8] A. P. Santhakumaran and S. V. Ullas Chandran, The hull number of strong product graphs, *Discuss. Math. Graph Theory*, 31(3) (2011), 493-507.

## Directed Pathos Block Line Cut-Vertex Digraph of an Arborescence

H. M. Nagesh

Department of Science and Humanities

PES Institute of Technology (Bangalore South Campus), Bangalore-560 100, India

R. Chandrasekhar

Department of Master of Computer Applications, T. John College, Bangalore-560 042, India

M. C. Mahesh Kumar

Department of Mathematics, Government First Grade College, K. R. Puram, Bangalore-560 036, India

E-mail: nageshnm@pes.edu, dr.chandri@gmail.com, softmahe15@gmail.com

**Abstract:** For an arborescence  $T$ , a *directed pathos block line cut-vertex digraph*  $Q = DPBL_c(T)$  has vertex set  $V(Q) = A(T) \cup C(T) \cup B(T) \cup P(T)$ , where  $C(T)$  is the cut-vertex set,  $B(T)$  is the block set, and  $P(T)$  is a directed pathos set of  $T$ . The arc set  $A(Q)$  consists of the following arcs:  $ab$  such that  $a, b \in A(T)$  and the head of  $a$  coincides with the tail of  $b$ ;  $Cd$  such that  $C \in C(T)$  and  $d \in A(T)$  and the tail of  $d$  is  $C$ ;  $dC$  such that  $C \in C(T)$  and  $d \in A(T)$  and the head of  $d$  is  $C$ ;  $Bc$  such that  $B \in B(T)$  and  $c \in A(T)$  and the arc  $c$  lies on the block  $B$ ;  $Pa$  such that  $a \in A(T)$  and  $P \in P(T)$  and the arc  $a$  lies on the directed path  $P$ ;  $P_iP_j$  such that  $P_i, P_j \in P(T)$  and it is possible to reach the head of  $P_j$  from the tail of  $P_i$  through a common vertex, but it is possible to reach the head of  $P_i$  from the tail of  $P_j$ . The problem of reconstructing an arborescence from its  $DPBL_c(T)$  is discussed. We present the characterization of digraphs whose  $DPBL_c(T)$  are planar and outer planar. In addition, a necessary and sufficient condition for  $DPBL_c(T)$  to have crossing number one is presented. Further we show that for any arborescence  $T$ ,  $DPBL_c(T)$  never be maximal outer planar and minimally nonouterplanar.

**Key Words:** Crossing number, inner vertex number, complete bipartite digraph.

**AMS(2010):** 05C20

### §1. Introduction

We shall assume that the reader is familiar with the standard terminology on graphs and digraphs and refer the reader to [1,4]. The concept of *pathos* of a graph  $G$  was introduced by Harary [2] as a collection of minimum number of edge disjoint open paths whose union is  $G$ .

The *path number* of a graph  $G$  is the number of paths in any pathos. The path number of

---

<sup>1</sup>Received May 18, 2016, Accepted November 26, 2016.

a tree  $T$  equals  $k$ , where  $2k$  is the number of odd degree vertices of  $T$ . Harary [3] and Stanton [8] calculated the path number of certain classes of graphs like trees and complete graphs.

H. M. Nagesh and R. Chandrasekhar [7] introduced the concept of a pathos block line cut-vertex graph of a tree.

A *pathos block line cut-vertex graph* of a tree  $T$ , written  $PBL_c(T)$ , is a graph whose vertices are the edges, paths of a pathos, cut-vertices, and blocks of  $T$ , with two vertices of  $PBL_c(T)$  adjacent whenever the corresponding edges of  $T$  are adjacent or the edge lies on the corresponding path of the pathos or the edge incident with the cut-vertex or the edge lies on the corresponding block; two distinct pathos vertices  $P_m$  and  $P_n$  of  $PBL_c(T)$  are adjacent whenever the corresponding paths of the pathos  $P_m(v_i, v_j)$  and  $P_n(v_k, v_l)$  have a common vertex.

The characterization of graphs whose  $PBL_c(T)$  are planar, outer planar, maximal outer planar, and minimally nonouterplanar were presented.

In this paper, we extend the definition of a pathos block line cut-vertex graph of a tree to an arborescence. Furthermore, some of its characterizations such as the planarity, outer planarity, etc., are discussed.

We need some concepts and notations on directed graphs. A *directed graph* (or just *digraph*)  $D$  consists of a finite non-empty set  $V(D)$  of elements called *vertices* and a finite set  $A(D)$  of ordered pair of distinct vertices called *arcs*. Here  $V(D)$  is the *vertex set* and  $A(D)$  is the *arc set* of  $D$ . If  $(u, v)$  or  $uv$  is an arc in  $D$ , then we say that  $u$  is a *neighbor* of  $v$ . A digraph  $D$  is *semicomplete* if for each pair of distinct vertices  $u$  and  $v$ , at least one of the arcs  $(u, v)$  and  $(v, u)$  exists in  $D$ . A semicomplete digraph of order  $n$  is denoted by  $D_n$ .

For a connected digraph  $D$ , a vertex  $z$  is called a *cut-vertex* if  $D - \{z\}$  has more than one connected component. A *block*  $B$  of a digraph  $D$  is a maximal weak subdigraph of  $D$ , which has no vertex  $v$  such that  $B - v$  is disconnected. An entire digraph is a block if it has only one block. There are exactly three categories of blocks: strong, strictly unilateral, and strictly weak". The *out-degree* of a vertex  $v$ , written  $d^+(v)$ , is the number of arcs going out from  $v$  and the *in-degree* of a vertex  $v$ , written  $d^-(v)$ , is the number of arcs coming into  $v$ . The *total degree* of a vertex  $v$ , written  $td(v)$ , is the number of arcs incident with  $v$ . We immediately have  $td(v) = d^-(v) + d^+(v)$ .

A vertex with an in-degree (out-degree) zero is called a *source* (*sink*). The directed path on  $n \geq 2$  vertices is the digraph  $\vec{P}_n = \{V(\vec{P}_n), E(\vec{P}_n), \eta\}$ , where  $V(\vec{P}_n) = \{u_1, u_2, \dots, u_n\}$ ,  $E(\vec{P}_n) = \{e_1, e_2, \dots, e_{n-1}\}$ , where  $\eta$  is given by  $\eta(e_i) = (u_i, u_{i+1})$ , for all  $i \in \{1, 2, \dots, (n-1)\}$ .

An *arborescence* is a directed graph in which, for a vertex  $u$  called the *root* (a vertex of in-degree zero) and any other vertex  $v$ , there is exactly one directed path from  $u$  to  $v$ . We shall use  $T$  to denote an arborescence. A *root arc* of  $T$  is an arc which is directed out from the root of  $T$ , i.e., an arc whose tail is the root of  $T$ .

Since most of the results and definitions for undirected planar graphs are valid for planar digraphs also, the following definitions hold good for planar digraphs.

If  $D$  is a planar digraph, then the *inner vertex number*  $i(D)$  of  $D$  is the minimum number of vertices not belonging to the boundary of the exterior region in any embedding of  $D$  in the plane. A digraph  $D$  is *outerplanar* if  $i(D) = 0$  and *minimally nonouterplanar* if  $i(D) = 1$  [5]. The *crossing number* of a digraph  $D$ , denoted by  $cr(D)$ , is the minimum number of crossings

of its arcs when the digraph  $D$  is drawn in the plane.

## §2. Definitions

**Definition 2.1** *The line digraph  $L(D)$  of a digraph  $D$  has the arcs of  $D$  as vertices. There is an arc from  $D$ -arc  $pq$  towards  $D$ -arc  $uv$  if and only if  $q = u$ .*

**Definition 2.2** *If a directed path  $\vec{P}_n$  starts at one vertex and ends at a different vertex, then  $\vec{P}_n$  is called an open directed path.*

**Definition 2.3** *The directed pathos of an arborescence  $T$  is defined as a collection of minimum number of arc disjoint open directed paths whose union is  $T$ .*

**Definition 2.4** *The directed path number  $k'$  of  $T$  is the number of open directed paths in any directed pathos of  $T$ , and is equal to the number of sinks in  $T$ .*

**Definition 2.5** *For an arborescence  $T$ , a directed pathos line cut-vertex digraph  $Q = DPL_c(T)$  has vertex set  $V(Q) = A(T) \cup C(T) \cup P(T)$ , where  $C(T)$  is the cut-vertex set and  $P(T)$  is a directed pathos set of  $T$ . The arc set  $A(Q)$  consists of the following arcs:  $ab$  such that  $a, b \in A(T)$  and the head of  $a$  coincides with the tail of  $b$ ;  $Cd$  such that  $C \in C(T)$  and  $d \in A(T)$  and the tail of  $d$  is  $C$ ;  $dC$  such that  $C \in C(T)$  and  $d \in A(T)$  and the head of  $d$  is  $C$ ;  $Pa$  such that  $a \in A(T)$  and  $P \in P(T)$  and the arc  $a$  lies on the directed path  $P$ ;  $P_iP_j$  such that  $P_i, P_j \in P(T)$  and it is possible to reach the head of  $P_j$  from the tail of  $P_i$  through a common vertex, but it is possible to reach the head of  $P_i$  from the tail of  $P_j$ .*

**Definition 2.6** *For an arborescence  $T$ , a directed pathos block line cut-vertex digraph  $Q = DPBL_c(T)$  has vertex set  $V(Q) = A(T) \cup C(T) \cup B(T) \cup P(T)$ , where  $C(T)$  is the cut-vertex set,  $B(T)$  is the block set, and  $P(T)$  is a directed pathos set of  $T$ . The arc set  $A(Q)$  consists of the following arcs:  $ab$  such that  $a, b \in A(T)$  and the head of  $a$  coincides with the tail of  $b$ ;  $Cd$  such that  $C \in C(T)$  and  $d \in A(T)$  and the tail of  $d$  is  $C$ ;  $dC$  such that  $C \in C(T)$  and  $d \in A(T)$  and the head of  $d$  is  $C$ ;  $Bc$  such that  $B \in B(T)$  and  $c \in A(T)$  and the arc  $c$  lies on the block  $B$ ;  $Pa$  such that  $a \in A(T)$  and  $P \in P(T)$  and the arc  $a$  lies on the directed path  $P$ ;  $P_iP_j$  such that  $P_i, P_j \in P(T)$  and it is possible to reach the head of  $P_j$  from the tail of  $P_i$  through a common vertex, but it is possible to reach the head of  $P_i$  from the tail of  $P_j$ .*

Note that the directed path number  $k'$  of an arborescence  $T$  is minimum only when the out-degree of the root of  $T$  is one. Therefore, unless otherwise specified, the out-degree of the root of every arborescence is exactly one. Finally, we assume that the direction of the directed pathos is along the direction of the arcs in  $T$ . Since the pattern of directed pathos for an arborescence is not unique, the corresponding directed pathos block line cut-vertex digraph is also not unique.

## §3. Basic Properties of $DPBL_c(T)$

**Remark 3.1** Since every arc of  $T$  is a block (strictly unilateral), the arcs directed out of block vertices reaches the vertices of  $L(T)$  does not affect the crossing number of  $DPBL_c(T)$ .

**Observation 3.2** If  $T$  is an arborescence of order  $n$  ( $n \geq 3$ ), then  $L(T) \subseteq L_c(T) \subseteq DPL_c(T) \subseteq DPBL_c(T)$ .

**Remark 3.3** The number of arcs whose tail and head are the directed pathos vertices in  $DPBL_c(T)$  is  $k' - 1$ .

**Proposition 3.4** Let  $T$  be an arborescence with vertex set  $V(T) = \{v_1, v_2, \dots, v_n\}$ , cut-vertex set  $C(T) = \{C_1, C_2, \dots, C_r\}$ , and block set  $B(T) = \{B_1, B_2, \dots, B_s\}$ . Then the order and size of  $DPBL_c(T)$  are

$$2(n-1) + k' + \sum_{j=1}^r C_j \quad \text{and} \quad \sum_{i=1}^n d^-(v_i) \cdot d^+(v_i) + \sum_{j=1}^r \{d^-(C_j) + d^+(C_j)\} + k' + 2n - 3,$$

respectively.

*Proof* Let  $T$  be an arborescence with vertex set  $V(T) = \{v_1, v_2, \dots, v_n\}$ , cut-vertex set  $C(T) = \{C_1, C_2, \dots, C_r\}$ , and block set  $B(T) = \{B_1, B_2, \dots, B_s\}$ . Then the order of  $DPBL_c(T)$  equals the sum of size, cut-vertices, blocks, and the directed path number  $k'$  of  $T$ . Since every arc of an arborescence is a block, the order of  $DPBL_c(T)$  is

$$\begin{aligned} n-1 + \sum_{j=1}^r C_j + n-1 + k', \\ \Rightarrow 2(n-1) + k' + \sum_{j=1}^r C_j. \end{aligned}$$

The size of  $DPBL_c(T)$  equals the sum of size of  $T$  and  $L(T)$ ; total degree of cut-vertices; and the number of arcs whose tail and head are the directed pathos vertices. By Remark 3.3, the size of  $DPBL_c(T)$  is,

$$\begin{aligned} \sum_{i=1}^n d^-(v_i) \cdot d^+(v_i) + \sum_{j=1}^r \{d^-(C_j) + d^+(C_j)\} + 2(n-1) + k' - 1, \\ \Rightarrow \sum_{i=1}^n d^-(v_i) \cdot d^+(v_i) + \sum_{j=1}^r \{d^-(C_j) + d^+(C_j)\} + k' + 2n - 3. \quad \square \end{aligned}$$

#### §4. A Criterion for Directed Pathos Block Line Cut-Vertex Digraphs

The main objective is to determine a necessary and sufficient condition that a digraph be a directed pathos block line cut-vertex digraph.

A *complete bipartite digraph* is a directed graph  $D$  whose vertices can be partitioned into non-empty disjoint sets  $A$  and  $B$  such that each vertex of  $A$  has exactly one arc directed towards each vertex of  $B$  and such that  $D$  contains no other arc.



**Theorem 4.1** A digraph  $T'$  is a directed pathos block line cut-vertex digraph of an arborescence  $T$  if and only if  $V(T') = A(T) \cup C(T) \cup B(T) \cup P(T)$  and arc sets

(1)  $\cup_{i=1}^n X_i \times Y_i$ , where  $X_i$  and  $Y_i$  are the sets of in-coming and out-going arcs at  $v_i$  of  $T$ , respectively;

(2)  $\cup_{j=1}^r \cup_{k=1}^r Z_j' \times C_k$  such that  $Z_j' \times C_k = \phi$  for  $j \neq k$ ;

(3)  $\cup_{k=1}^r \cup_{j=1}^r C_k \times Z_j$  such that  $C_k \times Z_j = \phi$  for  $k \neq j$ , where  $Z_j'$  and  $Z_j$  are the sets of in-coming and out-going arcs at  $C_k$  of  $T$ , respectively.

(iv)  $\cup_{k=1}^t \cup_{j=1}^t P_k \times Y_j$  such that  $P_k \times Y_j = \phi$  for  $k \neq j$ ;

(4)  $\cup_{k=1}^t \cup_{j=1}^t P_k \times Y_j'$  such that  $P_k \times Y_j' = \phi$  for  $k \neq j$ , where  $Y_j$  is the set of arcs on which  $P_k$  lies and  $Y_j'$  is the set of directed paths whose heads are reachable from the tail of  $P_k$  through a common vertex in  $T$ ;

(5)  $\cup_{l=1}^s \cup_{l'=1}^s B_l \times N_{l'}$  such that  $B_l \times N_{l'} = \phi$  for  $l \neq l'$ , where  $N_{l'}$  is the set of arcs lies on  $B_l$  in  $T$ .

*Proof* Let  $T$  be an arborescence with vertex set  $V(T) = \{v_1, v_2, \dots, v_n\}$ , cut-vertex set  $C(T) = \{C_1, C_2, \dots, C_r\}$ , block set  $B(T) = \{B_1, B_2, \dots, B_s\}$ , and a directed pathos set  $P(T) = \{P_1, P_2, \dots, P_t\}$ . We consider the following cases.

**Case 1.** Let  $v$  be a vertex of  $T$  with  $d^-(v) = \alpha$  and  $d^+(v) = \beta$ . Then  $\alpha$  arcs coming into  $v$  and the  $\beta$  arcs going out of  $v$  give rise to a complete bipartite subdigraph with  $\alpha$  tails and  $\beta$  heads and  $\alpha \cdot \beta$  arcs joining each tail with each head. This is the decomposition of  $L(T)$  into mutually arc disjoint complete bipartite subdigraphs.

**Case 2.** Let  $C_i$  be a cut-vertex of  $T$  with  $d^-(C_i) = \alpha'$ . Then  $\alpha'$  arcs coming into  $C_i$  give rise to a complete bipartite subdigraph with  $\alpha'$  tails and a single head (i.e.,  $C_i$ ) and  $\alpha'$  arcs joining each tail with  $C_i$ .

**Case 3.** Let  $C_i$  be a cut-vertex of  $T$  with  $d^+(C_i) = \beta'$ . Then  $\beta'$  arcs going out of  $C_i$  give rise to a complete bipartite subdigraph with a single tail (i.e.,  $C_i$ ) and  $\beta'$  heads and  $\beta'$  arcs joining  $C_i$  with each head.

**Case 4.** Let  $P_j$  be a directed path which lies on  $\alpha''$  arcs in  $T$ . Then  $\alpha''$  arcs give rise to a complete bipartite subdigraph with a single tail (i.e.,  $P_j$ ) and  $\alpha''$  heads and  $\alpha''$  arcs joining  $P_j$  with each head.

**Case 5.** Let  $P_j$  be a directed path, and let  $\beta''$  be the number of directed paths whose heads are reachable from the tail of  $P_j$  through the common vertex in  $T$ . Then  $\beta''$  arcs give rise to a complete bipartite subdigraph with a single tail (i.e.,  $P_j$ ) and  $\beta''$  heads and  $\beta''$  arcs joining  $P_j$  with each head.

**Case 6.** Let  $B_p$  be a block of  $T$ . Then the arcs, say  $\gamma$  lies on  $B_p$  give rise to a complete bipartite subdigraph with a single tail (i.e.,  $B_p$ ) and  $\gamma$  heads and  $\gamma$  arcs joining  $B_p$  with each head.

Hence by all the above cases,  $Q = DPBL_c(T)$  is decomposed into mutually arc-disjoint complete bipartite subdigraphs with  $V(Q) = A(T) \cup C(T) \cup B(T) \cup P(T)$  and arc sets (i)  $\cup_{i=1}^n X_i \times Y_i$ , where  $X_i$  and  $Y_i$  are the sets of in-coming and out-going arcs at  $v_i$  of  $T$ , respectively.

- (2)  $\cup_{j=1}^r \cup_{k=1}^r Z'_j \times C_k$  such that  $Z'_j \times C_k = \phi$  for  $j \neq k$ .
- (3)  $\cup_{k=1}^r \cup_{j=1}^r C_k \times Z_j$  such that  $C_k \times Z_j = \phi$  for  $k \neq j$ , where  $Z'_j$  and  $Z_j$  are the sets of in-coming and out-going arcs at  $C_k$  of  $T$ , respectively.
- (4)  $\cup_{k=1}^t \cup_{j=1}^t P_k \times Y_j$  such that  $P_k \times Y_j = \phi$  for  $k \neq j$ .
- (5)  $\cup_{k=1}^t \cup_{j=1}^t P_k \times Y'_j$  such that  $P_k \times Y'_j = \phi$  for  $k \neq j$ , where  $Y_j$  is the set of arcs on which  $P_k$  lies and  $Y'_j$  is the set of directed paths whose heads are reachable from the tail of  $P_k$  through a common vertex in  $T$ .
- (6)  $\cup_{l=1}^s \cup_{l'=1}^s B_l \times N_{l'}$  such that  $B_l \times N_{l'} = \phi$  for  $l \neq l'$ , where  $N_{l'}$  is the set of arcs lies on  $B_l$  in  $T$ .

Conversely, let  $T'$  be a digraph of the type described above. Let  $t_1, t_2, \dots, t_l$  be the vertices corresponding to complete bipartite subdigraphs  $T_1, T_2, \dots, T_l$  of Case 1, respectively; and let  $w^1, w^2, \dots, w^t$  be the vertices corresponding to complete bipartite subdigraphs  $P'_1, P'_2, \dots, P'_t$  of Case 4, respectively. Finally, let  $t_0$  be a vertex chosen arbitrarily.

For each vertex  $v$  of the complete bipartite subdigraphs  $T_1, T_2, \dots, T_l$ , we draw an arc  $a_v$  as follows.

- (a) If  $d^+(v) > 0$ ,  $d^-(v) = 0$ , then  $a_v := (t_0, t_i)$ , where  $i$  is the base (or index) of  $T_i$  such that  $v \in Y_i$ .
- (b) If  $d^+(v) > 0$ ,  $d^-(v) > 0$ , then  $a_v := (t_i, t_j)$ , where  $i$  and  $j$  are the indices of  $T_i$  and  $T_j$  such that  $v \in X_j \cap Y_i$ .
- (c) If  $d^+(v) = 0$ ,  $d^-(v) = 1$ , then  $a_v := (t_j, w^n)$  for  $1 \leq n \leq t$ , where  $j$  is the base of  $T_j$  such that  $v \in X_j$ .

Note that, in  $(t_j, w^n)$  no matter what the value of  $j$  is,  $n$  varies from 1 to  $t$  such that the number of arcs of the form  $(t_j, w^n)$  is exactly  $t$ .

We mark the cut-vertices as follows. From Case 2 and Case 3, we observe that for every cut vertex  $C$ , there exists exactly two complete bipartite subdigraphs, one containing  $C$  as the tail, and other as head. Let it be  $C'_j$  and  $C''_j$  for  $1 \leq j \leq r$  such that  $C'_j$  contains  $C$  as the tail and  $C''_j$  as head. If the heads of  $C'_j$  and tails of  $C''_j$  are the heads and tails of a single  $T_i$  for  $1 \leq i \leq l$ , then the vertex  $t_i$  is a cut-vertex, where  $i$  is the index of  $T_i$ .

We now mark the directed pathos as follows. It is easy to observe that the directed path number  $k'$  equals the number of subdigraphs of Case 4. Let  $\psi_1, \psi_2, \dots, \psi_t$  be the number of heads of subdigraphs  $P'_1, P'_2, \dots, P'_t$ , respectively. Suppose we mark the directed path  $P_1$ . For this we choose any  $\psi_1$  number of arcs and mark  $P_1$  on  $\psi_1$  arcs. Similarly, we choose  $\psi_2$  number of arcs and mark  $P_2$  on  $\psi_2$  arcs. This process is repeated until all directed pathos are marked. The digraph  $T$  with directed pathos and cut-vertices thus constructed apparently has  $T'$  as directed pathos block line cut-vertex digraph.  $\square$

Given a directed pathos block line cut-vertex digraph  $Q$ , the proof of the sufficiency of above theorem shows how to find an arborescence  $T$  such that  $DPBL_c(T) = Q$ . This obviously raises the question of whether  $Q$  determines  $T$  uniquely. Although the answer to this in general is no, the extent to which  $T$  is determined is given as follows.

One can easily check that using reconstruction procedure of the sufficiency of above theorem, any arborescence (without directed pathos) is uniquely reconstructed from its directed

pathos block line cut-vertex digraph. Since the pattern of directed pathos for an arborescence is not unique, there is freedom in marking directed pathos for an arborescence in different ways. This clearly shows that if the directed path number is one, any arborescence with directed pathos is uniquely reconstructed from its directed pathos block line cut-vertex digraph. It is known that a directed path is a special case of an arborescence. Since the directed path number  $k'$  of a directed path  $\vec{P}_n$  of order  $n$  ( $n \geq 3$ ) is exactly one, a directed path with a directed pathos is uniquely reconstructed from its directed pathos block line cut-vertex digraph.

### §5. Characterization of $DPBL_c(T)$

**Theorem 5.1** *A directed pathos block line cut-vertex digraph  $DPBL_c(T)$  of an arborescence  $T$  is planar if and only if the total degree of each vertex of  $T$  is at most three.*

*Proof* Suppose  $DPBL_c(T)$  is planar. Assume that  $td(v) \geq 4$ , for every vertex  $v \in T$ . Suppose there exists a vertex  $v$  of total degree four in  $T$ , that is,  $T$  is an arborescence whose underlying graph is  $K_{1,4}$ . Let  $V(T) = \{a, b, c, d, e\}$  and  $A(T) = \{(a, c), (c, b), (c, d), (c, e)\}$  such that  $a$  and  $(a, c)$  are the root and root arc of  $T$ , respectively. By definition,  $A(L(T)) = \{(ac, cb), (ac, cd), (ac, ce)\}$ . Since  $c$  is the cut-vertex of  $T$ , it is the tail of arcs  $(c, b), (c, d), (c, e)$ ; and the head of an arc  $(a, c)$ . Then  $c$  is a neighbor of vertices  $cb, cd, ce$ ; and  $ac$  is a neighbor of  $c$ . This shows that  $cr(L_c(T)) = 0$ . Let  $P(T) = \{P_1, P_2, P_3\}$  be a directed pathos set of  $T$  such that  $P_1$  lies on the arcs  $(a, c), (c, b)$ ;  $P_2$  lies on  $(c, d)$ ; and  $P_3$  lies on  $(c, e)$ . Then  $P_1$  is a neighbor of  $ac, cb, P_2, P_3$ ;  $P_2$  is a neighbor of  $cd$ ; and  $P_3$  is a neighbor of  $ce$ . Clearly  $cr(DPL_c(T)) = 1$ . By Remark 3.1,  $cr(DPBL_c(T)) = 1$ , a contradiction.

Conversely, suppose that the total degree of each vertex of  $T$  is at most three. Let  $V(T) = \{v_1, v_2, \dots, v_n\}$  and  $A(T) = \{e_1, e_2, \dots, e_{n-1}\}$  such that  $v_1$  and  $e_1 = (v_1, v_2)$  are the root and root arc of  $T$ , respectively. By definition,  $L(T)$  is an out-tree of order  $n - 1$ . The number of cut-vertices of  $T$  equals the number of vertices whose total degree is at least two. Then  $L_c(T)$  is a connected digraph in which every block is either  $D_3$  or  $D_4 - e$ . Furthermore, the directed path number  $k'$  is the number of sinks in  $T$ . Then the arcs joining vertices of  $L(T)$  and directed pathos vertices; and arcs joining directed pathos vertices gives  $DPL_c(T)$  such that  $cr(DPL_c(T)) = 0$ . By Remark 3.1,  $cr(DPBL_c(T)) = 0$ . This completes the proof.  $\square$

**Theorem 5.2** *A directed pathos block line cut-vertex digraph  $DPBL_c(T)$  of an arborescence  $T$  is outer planar if and only if  $T$  is a directed path  $\vec{P}_n$  of order  $n$  ( $n \geq 3$ ).*

*Proof* Suppose  $DPBL_c(T)$  is outer planar. Assume that  $T$  is an arborescence whose underlying graph is  $K_{1,3}$ . Let  $V(T) = \{a, b, c, d\}$  and  $A(T) = \{(a, b), (b, c), (b, d)\}$  such that  $a$  and  $(a, b)$  are the root and root arc of  $T$ , respectively. Then  $A(L(T)) = \{(ab, bc), (ab, bd)\}$ . Since  $b$  is the cut-vertex of  $T$ , it is the tail of arcs  $(b, c), (b, d)$ ; and the head of an arc  $(a, b)$ . By definition,  $L_c(T) = D_4 - e$ . Clearly  $i(L_c(T)) = 0$ . Let  $P(T) = \{P_1, P_2\}$  be a directed pathos set of  $T$  such that  $P_1$  lies on the arcs  $(a, b), (b, c)$ ; and  $P_2$  lies on  $(b, d)$ . Then  $P_1$  is a neighbor of  $ab, bc, P_2$ ; and  $P_2$  is a neighbor of  $bd$ . This shows that  $i(DPL_c(T)) = 1$ . Since every arc of  $T$  is a block, let  $B_1, B_2, B_3$  be blocks corresponding to arcs  $(a, b), (b, c), (b, d)$ , respectively.

Then the arcs joining  $B_1$  and  $ab$ ;  $B_2$  and  $bc$ ; and  $B_3$  and  $bd$  increases the inner vertex number of  $DPL_c(T)$  by one. Thus  $i(DPBL_c(T)) = 2$ , a contradiction.

Conversely, suppose that  $T$  is a directed path of order  $n$  ( $n \geq 3$ ). Let  $V(T) = \{v_1, v_2, \dots, v_n\}$  and  $A(T) = \{e_1, e_2, \dots, e_{n-1}\}$ . Clearly, the directed path number of  $T$  is one. Then the underlying graph of  $DPL(T)$  is the fan graph  $F_{1, n-1}$ . Let  $C(T) = \{C_1, C_2, \dots, C_{n-2}\}$  be the cut-vertex set of  $T$  such that the arcs  $e_i$  are directed into the cut-vertices  $C_i$ , and  $e_{i+1}$  are directed out of  $C_i$  for  $1 \leq i \leq n-2$ . Then the vertices  $e_i$  are the neighbors of  $C_i$ , and  $C_i$  are the neighbors of  $e_{i+1}$ . This shows that  $i(DPL_c(T)) = 0$ . Since every arc of  $T$  is a block, by Remark 3.1,  $i(DPBL_c(T)) = 0$ .  $\square$

**Theorem 5.3**(F. Harary, [1]) *Every maximal outer planar graph  $G$  with  $n$  vertices has  $2n - 3$  edges.*

**Theorem 5.4** *For any arborescence  $T$ ,  $DPBL_c(T)$  is not maximal outerplanar.*

*Proof* We use contradiction. Suppose that  $DPBL_c(T)$  is maximal outer planar. We consider the following three cases.

**Case 1.** Suppose that  $td(v) \geq 4$ , for every vertex  $v \in T$ . By Theorem 5.1,  $DPBL_c(T)$  is nonplanar, a contradiction.

**Case 2.** Suppose there exists a vertex of total degree three in  $T$ . By necessity of Theorem 5.2,  $DPBL_c(T)$  nonouterplanar, a contradiction.

**Case 3.** Suppose that  $T$  is a directed path  $\vec{P}_n$  of order  $n$  ( $n \geq 3$ ). By Proposition 3.4, the order and size of  $DPBL_c(T)$  are  $3\alpha + 3$  and  $5\alpha + 2$ , respectively, where  $\alpha = (n-2)$ ,  $n \geq 3$ . But  $5\alpha + 2 < 6\alpha + 3 = 2(3\alpha + 3) - 3$ . By Theorem 5.3,  $DPBL_c(T)$  is not maximal outerplanar, again a contradiction. Hence by all the above cases,  $DPBL_c(T)$  is not maximal outerplanar.  $\square$

**Theorem 5.5** *For any arborescence  $T$ ,  $DPBL_c(T)$  is not minimally nonouter planar.*

*Proof* We use contradiction. Suppose that  $DPBL_c(T)$  is minimally nonouter planar. We consider the following three cases.

**Case 1.** Suppose that  $td(v) \geq 4$ , for every vertex  $v \in T$ . By Theorem 5.1,  $DPBL_c(T)$  is nonplanar, a contradiction.

**Case 2.** Suppose there exists a vertex of total degree three in  $T$ . By necessity of Theorem 5.2,  $i(DPBL_c(T)) = 2$ , a contradiction.

**Case 3.** Suppose that  $T$  is a directed path  $\vec{P}_n$  of order  $n$  ( $n \geq 3$ ). By Theorem 5.2,  $DPBL_c(T)$  is outer planar, again a contradiction. Hence by all the above cases,  $DPBL_c(T)$  is not minimally nonouterplanar.  $\square$

**Theorem 5.6** *A directed pathos block line cut-vertex digraph  $DPBL_c(T)$  of an arborescence  $T$  has crossing number one if and only if the underlying graph of  $T$  is  $K_{1,4}$ .*

*Proof* Suppose  $DPBL_c(T)$  has crossing number one. Assume that  $T$  is an arborescence whose underlying graph is a star graph  $K_{1,n}$  on  $n \geq 5$  vertices. Suppose  $T = K_{1,5}$ . Let  $V(T) = \{a, b, c, d, e, f\}$  and  $A(T) = \{(a, c), (c, b), (c, d), (c, e), (c, f)\}$  such that  $a$  and  $(a, c)$  are the root and root arc of  $T$ , respectively. Then  $A(L(T)) = \{(ac, cb), (ac, cd), (ac, ce), (ac, cf)\}$ . Since  $c$  is the cut-vertex of  $T$ , it is the tail of arcs  $(c, b), (c, d), (c, e), (c, f)$ ; and the head of an arc  $(a, c)$ . Then  $c$  is a neighbor of vertices  $cb, cd, ce, cf$ ; and  $ac$  is a neighbor of  $c$ . This shows that  $cr(L_c(T)) = 0$ . Let  $P(T) = \{P_1, P_2, P_3, P_4\}$  be a directed pathos set of  $T$  such that  $P_1$  lies on the arcs  $(a, c), (c, b)$ ;  $P_2$  lies on  $(c, d)$ ;  $P_3$  lies on  $(c, e)$ ; and  $P_4$  lies on  $(c, f)$ . Then  $P_1$  is a neighbor of  $ac, cb, P_2, P_3, P_4$ ;  $P_2$  is a neighbor of  $cd$ ;  $P_3$  is a neighbor of  $ce$ ; and  $P_4$  is a neighbor of  $cf$ . This shows that  $cr(DPL_c(T)) = 2$ . By Remark 3.1,  $cr(DPBL_c(T)) = 2$ , a contradiction.

Conversely, suppose that  $T$  is an arborescence whose underlying graph is  $K_{1,4}$ . By necessity of Theorem 5.1,  $cr(DPBL_c(T)) = 1$ . This completes the proof.  $\square$

## References

- [1] F. Harary, *Graph Theory*, Addison-Wesley, Reading, Mass (1969).
- [2] F. Harary, Covering and packing in graphs-I, *Annals of New York Academy of Science*, 175 (1970), 198-205.
- [3] F. Harary and A. J. Schwenk, Evolution of the path number of a graph: Covering and packing in graphs-II, *Graph Theory and Computing, Ed. Read.*, R.C. Academic Press, New York (1972), 39-45.
- [4] Jorgen Bang-Jensen and Gregory Gutin, *Digraphs Theory, Algorithms and Applications*, Springer.
- [5] V. R. Kulli, On minimally non-outerplanar graphs, *Proceedings of Indian National Science Academy*, 41(1975), 276-280.
- [6] H. M. Nagesh and R. Chandrasekhar, Line cut-vertex digraphs of digraphs. *International J.Math. Combin.*, 4:99-103, 2015.
- [7] H. M. Nagesh and R. Chandrasekhar, Characterization of pathos adjacency blicit graph of a tree. *International J.Math. Combin.*, 1:61-66, 2014.
- [8] R. G. Stanton, D. D. Cowan, and L. O. James, Some results on path numbers, *Proceedings of the Louisiana Conference on Combinatorics*, Graph Theory and Computing (1970), 112-135.

## Spherical Chains Inside a Spherical Segment

Buddhadev Pal

Institute of Science, Department of Mathematics  
Banaras Hindu University, Varanasi, Uttar Pradesh 221005, India

Santu Dey and Arindam Bhattacharyya

Faculty of Science, Department of Mathematics, Jadavpur University, Kolkata 700032, India

E-mail: buddha.pal@rediffmail.com, santu.mathju@gmail.com, bhattachar1968@yahoo.co.in

**Abstract:** The present paper deals with a spherical chain whose centers lie on a horizontal plane which can be drawn inside a spherical fragment and we display some geometric properties related to the chain itself. Here, we also grant recursive and non recursive formulas for calculating the coordinates of the centers and the radii of the spheres.

**Key Words:** Spherical chain, horizontal plane, continued fraction.

**AMS(2010):** 51N20

### §1. Introduction

Let us consider a sphere “ $ABEFA$ ” with diameter  $AE$  and center  $L$ . If we cut this sphere by a plane, parallel to the coordinate planes then we get a circle and this intersection plane that contains the circle is nothing but the  $Y_1 = 0$  plane. Because we construct the coordinate system at the point  $I$  (see Figure 1), it is the intersection between the diameter( $AE$ ) of the sphere “ $ABEFA$ ” and the plane  $Y_1 = 0$ . It is possible to construct an infinite chain of spheres inside a spherical fragment where the centers of all sphere of the chain lie on a horizontal plane, parallel to the  $X_1Y_1$  plane or may be  $X_1Y_1$  plane and each sphere tangent to the plane  $Y_1 = 0$  and spherical fragment, that contains  $FEB$  and to its two immediate neighbors.

Let  $2(a_1 + b_1)$  be the diameter of the sphere and  $2b_1$  be the length of the segment  $IE$ . Here we have set up a Cartesian coordinate system with origin at  $I$  and let us consider sphere with center  $(x_i^1, y_i^1, k_1)$  which lie on a horizontal plane, parallel to the  $x^1y^1$  plane or may be  $x^1y^1$  plane, it depends upon the value of  $k_1$  and radius  $r_0^1$  tangent to the plane  $Y_1 = 0$  and the spherical fragment, that containing  $FEB$ . Now, we construct a infinite chain of tangent spheres, with centers  $(x_i^1, y_i^1, k_1)$  which lie on a horizontal plane, parallel to the  $X_1Y_1$  plane or may be  $X_1Y_1$  plane, it depends upon the value of  $k_1$  and radii  $r_i^1$  for integer value of  $i$ , positive and negative and  $k_1$  is fixed but the values of  $k_1$  may be positive, negative or zero. That means for particular values of  $k_1$ , we get a sequence of horizontal planes parallel to  $X_1Y_1$  plane. Therefore

---

<sup>1</sup>Received June 23, 2016, Accepted November 28, 2016.

if we consider any horizontal parallel plane corresponding to the  $X_1Y_1$  plane then there exist a spherical chain for which the center of the spheres of the spherical chains lies on that plane.

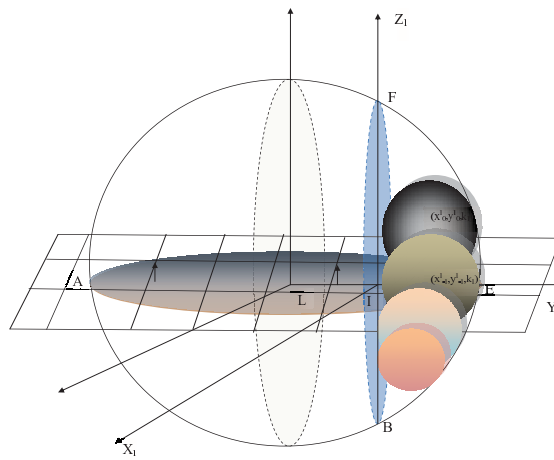

Figure 1. Spherical Chains inside a spherical segment

In this paper, we have learnt that the locus of the centers of the spherical chain mentioned above is a certain type of curve. Here, we have exhibited that locus of the point of centers of the spheres of the chain lie on a sphere. We have also inferred recursive and non recursive formulae to find coordinates of centers and radii of the spheres of a spherical chain.

§2. Some Geometric Properties of the Spherical Chain

Here we have speculated some basic properties of the infinite chain of spheres as mentioned above.

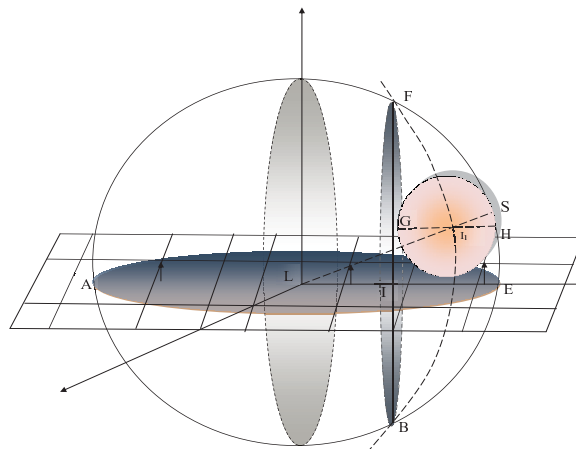

Figure 2.1 Centers of the spheres in chain on a parabola

**Proposition 2.1** *The centers of the spheres of the spherical chain on a horizontal plane, lie on a parabola with axis parallel to  $Y_1$ -axis, focus is at a height  $k_1$  from  $L$  and the vertex is at  $(0, b_1 - \frac{k_1^2}{4a_1}, k_1)$ . If we draw Figure 2.1 explicitly, then*

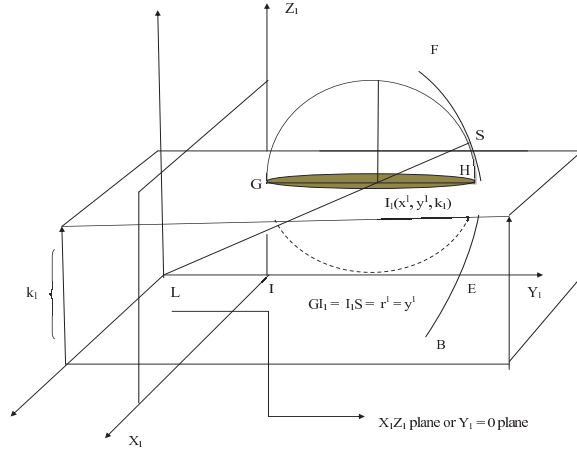

Figure 2.2 Centers of the spheres in chain on a parabola

*Proof* Let us consider a sphere of the chain with center  $I_1(x^1, y^1, k_1)$ , lie on a horizontal plane which is parallel to the coordinate plane  $X_1Y_1$ , diameter  $GH$ , radius  $r^1$ , tangent to the spherical arc  $FEB$  at  $S$ . Since  $LS$  contains  $I_1$  (see Figure 2.2), we have by taking into account that  $L$ , where  $L$  is the center of the sphere which contains the spherical chains, has coordinate  $(0, b_1 - a_1, 0)$  and

$$LS = a_1 + b_1,$$

$$LI_1 = \sqrt{(x^1)^2 + (y^1 - b_1 + a_1)^2 + (k_1)^2},$$

$$I_1S = GI_1 = r^1 = y^1.$$

Now, it is clear that

$$LI_1 = LS - I_1S.$$

From these, we have

$$\sqrt{(x^1)^2 + (y^1 - b_1 + a_1)^2 + (k_1)^2} = a_1 + b_1 - y^1,$$

which simplifies into

$$(x^1)^2 = -4a_1 \left\{ y^1 - \left( b_1 - \frac{k_1^2}{4a_1} \right) \right\}. \tag{1}$$

This clearly represents a parabola which is symmetric with respect to the axis parallel to  $Y_1$ -axis with vertex  $\left(0, b_1 - \frac{(k_1)^2}{4a_1}, k_1\right)$  and focus  $\left(0, b_1 - a_1 - \frac{(k_1)^2}{4a_1}, k_1\right)$ , where  $L$  is the center of the sphere.  $\square$

**Proposition 2.2** *The points of tangency between consecutive spheres of the chain lie on a sphere.*



*Proof* Consider two neighboring spheres with centers  $(x_i^1, y_i^1, k_1)$ ,  $(x_{i+1}^1, y_{i+1}^1, k_1)$ , radii  $r_i^1$ ,  $r_{i+1}^1$  respectively, tangent to each other at  $U_i$ , see Figure 3.

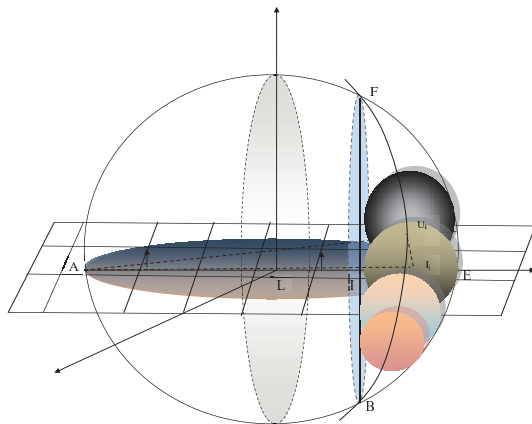

Figure 3. Points of tangency on a spherical arc

By using Proposition 2.1 and noting that  $A$  has coordinate  $(0, -2a_1, 0)$ , we have

$$AI_i^2 = (x_i^1)^2 + (y_i^1 + 2a_1)^2 + (k_1)^2 = (x_i^1)^2 + \left\{ -\frac{(x^1)^2}{4a_1} + b_1 - \frac{(k_1)^2}{4a_1} \right\}^2 + (k_1)^2,$$

$$(r_i^1)^2 = (y_i^1)^2 = \left\{ -\frac{(x^1)^2}{4a_1} + b_1 - \frac{k_1^2}{4a_1} \right\}^2.$$

Applying the Pythagorean theorem to the right triangle  $AI_iU_i$ , we have

$$AU_i^2 = AI_i^2 - (r_i^1)^2 = 4a_1(a_1 + b_1) = AI \cdot AE = AF^2.$$

Thus it follows that  $U_i$  lie on the sphere with center at  $A$  and radius  $AF$ . □

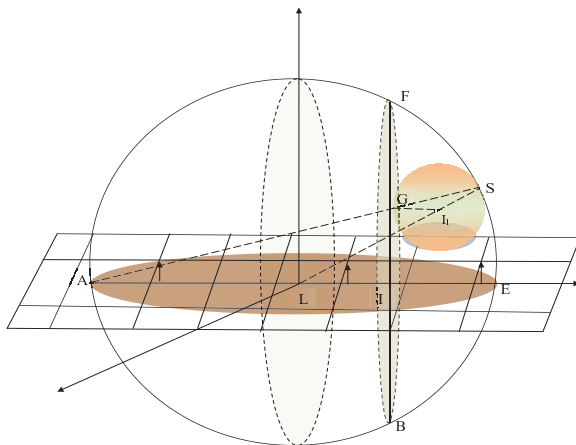

Figure 4. Line joining points of tangency

**Proposition 2.3** *If a sphere of the chain touches the plane  $Y_1 = 0$  at  $G$  and touches the spherical fragment  $FEB$  at  $S$ , then the points  $A$  (end point of the diameter opposite to plane  $Y_1 = 0$ ),  $G, S$  are collinear.*

*Proof* Suppose a sphere has center  $I_1$  of a spherical chain which touches the plane  $Y_1 = 0$  at  $G$  and the spherical fragment  $FEB$  at  $S$ , see Figure 4. Note that triangles  $LAS$  and  $I_1GS$  are isosceles triangles where  $\angle LSA = \angle LAS = \angle I_1SG = \angle I_1GS$ . Thus  $A, G, S$  must be collinear as the triangles  $LAS$  and  $I_1GS$  are similar.

### §3. Recursive and Non-Recursive Formulae to Find Coordinates of Centers and Radii of the Spheres of a Spherical Chain

From Figure 5, the triangle  $I_i I_{i-1} A_i$  is right angle triangle (as  $I_i A_i$  is perpendicular drawn on  $r_{i-1}^1$ ) with the centers  $I_{i-1}$  and  $I_i$  of two neighboring spheres of the chain.

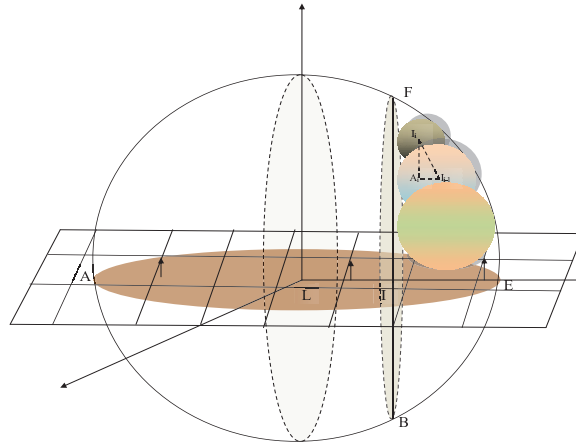

Figure 5. Construction for determination of recursive formula

Since these spheres have radii  $r_{i-1}^1 = y_{i-1}^1$  and  $r_i^1 = y_i^1$  respectively, we have

$$(x_i^1 - x_{i-1}^1)^2 + (y_i^1 - y_{i-1}^1)^2 + (k_1 - k_i)^2 = (r_i^1 + r_{i-1}^1)^2 = (y_i^1 + y_{i-1}^1)^2,$$

$$(x_i^1 - x_{i-1}^1)^2 = 4y_i^1 y_{i-1}^1.$$

Using (1), we can write

$$(x_i^1 - x_{i-1}^1)^2 = 4 \left\{ b_1 - \frac{k_1^2}{4a_1} - \frac{(x_i^1)^2}{4a_1} \right\} \left\{ b_1 - \frac{k_1^2}{4a_1} - \frac{(x_{i-1}^1)^2}{4a_1} \right\},$$

or

$$\frac{4a_1 \left\{ a_1 + b_1 - \frac{k_1^2}{4a_1} \right\} - (x_{i-1}^1)^2}{4a_1^2} \cdot (x_i^1)^2 - 2x_{i-1}^1 x_i^1 + \frac{\left\{ a_1 + b_1 - \frac{k_1^2}{4a_1} \right\} x_{i-1}^2 - 4a_1 \left\{ b_1 - \frac{k_1^2}{4a_1} \right\}^2}{a_1} = 0. \quad (2)$$

If we index the spheres in the chain in such a way that the coordinate  $x_i^1$  increases with

the index  $i$ , then from (2) we have

$$x_i^1 = \frac{2x_{i-1}^1 - \left\{ (x_{i-1}^1)^2/a_1 - 4(b_1 - k_1^2/4a_1) \right\} \sqrt{1 + \frac{(b_1 - k_1^2/4a_1)}{a_1}}}{2 \left\{ 1 + \frac{(b_1 - k_1^2/4a_1)}{a_1} - \frac{(x_{i-1}^1)^2}{4a_1^2} \right\}}. \quad (3)$$

This is a recursive formula that can be applied provided that  $x_0^1$  of the first circle is known. Note that  $x_0^1$  must be chosen in the interval  $\left\{ -2\sqrt{a_1(b_1 - k_1^2/4a_1)}, 2\sqrt{a_1(b_1 - k_1^2/4a_1)} \right\}$ . Now the  $z^1$  coordinate is  $k_1$  and  $y_i^1$  are radii derived from (1), by

$$y_i^1 = r_i^1 = b_1 - \frac{k_1^2}{4a_1} - \frac{(x_i^1)^2}{4a_1}. \quad (4)$$

Now, it is possible to transform the recursion formula into a continued fraction and after some calculations, we get

$$x_i^1 = 2a_1 \left\{ \sqrt{1 + \frac{(b_1 - k_1^2/4a_1)}{a_1}} - \frac{1}{\frac{x_{i-1}^1}{2a_1} + \sqrt{1 + \frac{(b_1 - k_1^2/4a_1)}{a_1}}} \right\}. \quad (5)$$

Let

$$\wp = 2\sqrt{1 + \frac{(b_1 - k_1^2/4a_1)}{a_1}}, \quad \text{and} \quad \xi_i = \frac{x_i^1}{2a_1} - \sqrt{1 + \frac{(b_1 - k_1^2/4a_1)}{a_1}}, \quad i = 1, 2, \dots, \quad (6)$$

then, we have

$$\xi_i = -\frac{1}{\wp + \xi_{i-1}}.$$

Thus, for positive integral values of  $i$ ,

$$\xi_i = -\frac{1}{\wp - \frac{1}{\wp - \frac{1}{\wp + \xi_{0+}}}}.$$

Here we have used  $\xi_{0+}$  in place of  $\xi_0$  and

$$\xi_{0+} = \frac{x_0^1}{2a_1} - \sqrt{1 + \frac{(b_1 - k_1^2/4a_1)}{a_1}}.$$

Now, if we solve equation (2) for  $x_{i-1}^1$  then we get

$$x_{i-1}^1 = \frac{2x_i^1 + \left\{ (x_i^1)^2/a_1 - 4(b_1 - k_1^2/4a_1) \right\} \sqrt{1 + \frac{(b_1 - k_1^2/4a_1)}{a_1}}}{2 \left\{ 1 + \frac{(b_1 - k_1^2/4a_1)}{a_1} - \frac{(x_i^1)^2}{4a_1^2} \right\}}. \quad (7)$$

Thus, for negative integral values of  $i$ , with

$$\xi_{-i} = \frac{x_{-i}^1}{2a_1} + \sqrt{1 + \frac{(b_1 - k_1^2/4a_1)}{a_1}},$$

we have

$$\xi_{-i} = -\frac{1}{-\wp - \frac{1}{-\wp - \frac{1}{-\wp - \frac{1}{-\wp + \xi_{0+}}}}},$$

where

$$\xi_{0-} = \frac{x_0^1}{2a_1} + \sqrt{1 + \frac{(b_1 - k_1^2/4a_1)}{a_1}}.$$

Therefore it is possible to give nonrecursive formulae for calculating  $x_i^1$  and  $x_{-i}^1$ . In the following, here we shall consider only  $x_i^1$  for positive integer indices because, as far as  $x_{-i}^1$  is concerned, it is enough to change, in all the formulae involved,  $\wp$  into  $-\wp$ ,  $x_i^1$  into  $x_{i-1}^1$ . Starting from (5), and by considering its particular structure, one can write, for  $i = 1, 2, 3, \dots$

$$\xi_i = -\frac{\mu_{i-1}(\wp)}{\mu_i(\wp)},$$

where  $\mu_i(\wp)$  are polynomials with integer coefficients. Here are the first five of them.

$\mu_0(\wp)$	1
$\mu_1(\wp)$	$\wp + \xi_{0+}$
$\mu_2(\wp)$	$(\wp^2 - 1) + \wp\xi_{0+}$
$\mu_3(\wp)$	$(\wp^3 - 2\wp) + (\wp^2 - 1)\xi_{0+}$
$\mu_4(\wp)$	$(\wp^4 - 3\wp^2 + 1) + (\wp^3 - 2\wp)\xi_{0+}$
$\mu_5(\wp)$	$(\wp^5 - 4\wp^3 + 3\wp) + (\wp^4 - 3\wp^2 + 1)\xi_{0+}$

According to a fundamental property of continued fraction [1], these polynomials satisfy the second order linear recurrence

$$\mu_i(\wp) = \wp\mu_{i-1}(\wp) - \mu_{i-2}(\wp). \tag{8}$$

We can further write

$$\mu_i(\wp) = \varphi_i(\wp) + \varphi_{i-1}(\wp)\xi_{0+}, \tag{9}$$

for a sequence of simpler polynomials  $\varphi_i(\wp)$ , each either odd or even. In fact, from (8) and (9), we have

$$\varphi_{i+2}(\wp) = \wp\varphi_{i+1}(\wp) - \varphi_i(\wp).$$

Explicitly,

$$\varphi_i(\wp) = \left\{ \begin{array}{ll} 1, & i = 0 \\ \sum_{n=0}^{\frac{i}{2}} (-1)^{\frac{i}{2}+n} \binom{\frac{i}{2}+n}{2n} \wp^{2n}, & i = 2, 4, 6, \dots \\ \sum_{n=1}^{\frac{i+1}{2}} (-1)^{\frac{i+1}{2}+n} \binom{\frac{i-1}{2}+n}{2n-1} \wp^{2n-1}, & i = 1, 3, 5, \dots \end{array} \right\}$$

From (6), we have

$$x_i^1 = a_1(\wp - 2 \frac{\mu_{i-1}(\wp)}{\mu_i(\wp)}), \quad (10)$$

for  $i = 1, 2, \dots$

**Note 3.1** One can also consider the planes parallel to  $Y^1 Z^1$  plane and  $Z^1 X^1$  plane.

### Acknowledgement

The second author is supported by DST/INSPIRE Fellowship/2013/1041, Govt. of India.

### References

- [1] H.Havenport, *Higher Arithmetic*, 6-th edition, Cambridge Univ. Press, 1992.
- [2] G.Lucca, Circle chains inside a circular segment, *Forum Geometricorum*, 9(2009), 173-179.

## A Note on Neighborhood Prime Labeling

Mathew Varkey T.K and Rajesh Kumar T.J

(Department of Mathematics, T.K.M College of Engineering, Kollam, Kerala, India)

E-mail: mathewvarkeytk@gmail.com, vptjrk@gmail.com

**Abstract:** A labeling or numbering of a graph  $G$  is an assignment of labels to the vertices of  $G$  that induces for each edge  $uv$  a labeling depending on the vertex labels  $f(u)$  and  $f(v)$ . In this paper, we investigate neighborhood prime labeling of graph obtained by identifying any two vertices of path  $P_n$ . We also discuss neighborhood prime labeling in some graph operations on the cycle  $C_n$ .

**Key Words:** Neighborhood prime labeling, fusion, vertex switching, path union.

**AMS(2010):** 05C78

### §1. Introduction

All graphs in this paper are finite, simple, undirected and having no isolated vertices. For all terminology and notations in graph theory, we follow [2] and for all terminology regarding graceful labeling, we follow [3]. The field of graph theory plays vital role in various fields. Graph labeling is one of the important area in graph theory. Graph labelings where the vertices are assigned values subject to certain conditions have been motivated by practical problems. Labeled graphs serves as useful mathematical models for a broad range of applications such as communication network addressing system, data base management, circuit designs, coding theory, X-ray crystallography, the design of good radar type codes, synch-set codes, missile guidance codes and radio astronomy problems etc. The detailed description of the applications of graph labelings can be seen in [1].

**Definition 1.1** Let  $G = (V(G), E(G))$  be a graph with  $p$  vertices. A bijection  $f: V(G) \rightarrow \{1, 2, 3, \dots, p\}$  is called prime labeling if for each edge  $e = uv$ ,  $\gcd(f(u), f(v)) = 1$ . A graph which admits prime labeling is called a prime graph.

The notion of prime labeling was introduced by Roger Entringer and was discussed in a paper by [4]. In [5] the author proved that the path  $P_n$  on  $n$  vertices is a prime graph. In [6] the author proved that the graph obtained by identifying any two vertices of path  $P_n$  is a prime graph. The prime labeling of some cycle related graphs were discussed in [7]. In [9] it is shown that  $C_n \times P_2$ ;  $C_n \cup K_{1,m}$ ,  $C_n \cup P_m$ ,  $K_{1,n} \cup P_n$ , Olive trees,  $P_n \odot K_1$ ,  $n \geq 2$ ,  $P_1 \cup P_2 \cup \dots \cup P_n$  have a prime labeling.

---

<sup>1</sup>Received January 14, 2016, Accepted November 28, 2016.

## §2. Neighborhood Prime Labeling

**Definition 2.1** ([8]) Let  $G = (V(G), E(G))$  be a graph with  $p$  vertices. A bijection  $f : V(G) \rightarrow \{1, 2, 3, \dots, p\}$  is called neighborhood prime labeling if for each vertex  $v \in V(G)$  with  $\deg(v) > 1$ ,  $\gcd\{f(u) : u \in N(v)\} = 1$ . A graph which admits neighborhood prime labeling is called a neighborhood prime graph.

For a vertex  $v \in V(G)$ , the neighborhood of  $v$  is the set of all vertices in  $G$  which are adjacent to  $v$  and is denoted by  $N(v)$ . If in a graph  $G$ , every vertex is of degree at most 1, then such a graph is neighborhood prime. S.K.Pater, N.P.Shrimali [8] proved that the path  $P_n$  is neighborhood prime graph for every  $n$ . They also proved that the cycle  $C_n$  is neighborhood prime if  $n \not\equiv 2 \pmod{4}$ . We consider some results on neighborhood prime labeling of path  $P_n$  and cycle  $C_n$ .

**Definition 2.2** Let  $u$  and  $v$  be two distinct vertices of a graph  $G$ . A new graph  $G_{u,v}$  is constructed by identifying (fusing) two vertices  $u$  and  $v$  by a single new vertex  $x$  such that every edge which was incident with either  $u$  or  $v$  in  $G$  is now incident with  $x$  in  $G_{u,v}$ .

**Definition 2.3** A vertex switching  $G_v$  of a graph  $G$  is obtained by taking a vertex  $v$  of  $G$ , removing all the edges incident with  $v$  and adding edges joining  $v$  to every vertex which are not adjacent to  $G$ .

**Definition 2.4** Let  $G_1, G_2, \dots, G_n, n \geq 2$  be  $n$  copies of a fixed graph  $G$ . The graph obtained by adding an edge between  $G_i$  and  $G_{i+1}$  for  $i = 1, 2, \dots, n-1$  is called the path union of  $G$ .

**Theorem 2.1** The graph obtained by identifying any two vertices of  $P_n$  is a neighborhood prime graph if  $n \not\equiv 3 \pmod{4}$ .

*Proof* Let  $v_1, v_2, \dots, v_n$  be the vertices of  $P_n$ . Let  $u$  be the new vertex of the graph  $G$  obtained by identifying two distinct vertices  $v_1$  and  $v_2$  of  $P_n$ . Then  $G$  is a loop with a path in  $n-1$  vertices. Since the path  $P_n$  is neighborhood prime for every  $n$ ,  $G$  is neighborhood prime. Let  $u$  be the new vertex of  $G$  obtained by identifying two distinct vertices  $v_a$  and  $v_b$  of  $P_n$ . Then  $G$  is a cycle (possibly loop) with at most two paths attached at  $u$ . The graph  $G$  is the disjoint union of cycle  $C'_n$  and the path  $P'_n$ . Consider the consecutive vertices of  $C'_n$  are  $u = u_1, u_2, \dots, u_r$  and the consecutive vertices of  $P'_n$  are  $v_0 = u, v_1, v_2, \dots, v_s$ . Define a function  $f : V(G) \rightarrow \{1, 2, 3, \dots, n-1\}$  as follows.

**Case 1.** If  $r$  and  $s$  are both even, define

$$f(u_{2i-1}) = \frac{n-1}{2} + i, 1 \leq i \leq \frac{r}{2}, \quad f(u_{2i}) = i, 1 \leq i \leq \frac{r}{2},$$

$$f(v_{2j-1}) = \frac{n+r-1}{2} + j, 1 \leq j \leq \frac{s}{2}, \quad f(v_{2j}) = \frac{r}{2} + j, 1 \leq j \leq \frac{s}{2}$$

**Case 2.** If  $r$  is even but  $s$  is odd, define

$$\begin{aligned} f(u_{2i-1}) &= \frac{n-2}{2} + i, 1 \leq i \leq \frac{r}{2}, & f(u_{2i}) &= i, 1 \leq i \leq \frac{r}{2}, \\ f(v_{2j-1}) &= \frac{n+r}{2} + j, 1 \leq j \leq \frac{s+1}{2}, & f(v_{2j}) &= \frac{r}{2} + j, 1 \leq j \leq \frac{s-1}{2}. \end{aligned}$$

**Case 3.** If  $r$  is odd but  $s$  is even, define

$$\begin{aligned} f(u_{2i-1}) &= \frac{n-2}{2} + i, 1 \leq i \leq \frac{r+1}{2}, & f(u_{2i}) &= i, 1 \leq i \leq \frac{r-1}{2}, \\ f(v_{2j-1}) &= \frac{n+r-1}{2} + j, 1 \leq j \leq \frac{s}{2}, & f(v_{2j}) &= \frac{r-1}{2} + j, 1 \leq j \leq \frac{s}{2}. \end{aligned}$$

**Case 4.** If  $r$  and  $s$  are both odd, define

$$\begin{aligned} f(u_{2i-1}) &= \frac{n-1}{2} + i, 1 \leq i \leq \frac{r+1}{2}, & f(u_{2i}) &= i, 1 \leq i \leq \frac{r-1}{2}, \\ f(v_{2j-1}) &= \frac{r-1}{2} + j, 1 \leq j \leq \frac{s+1}{2}, & f(v_{2j}) &= \frac{n+r}{2} + j, 1 \leq j \leq \frac{s-1}{2}. \end{aligned}$$

Clearly,  $f$  is an injective map. We claim  $f$  is neighborhood prime labeling due to the following:

(1) If  $v_j$  is a vertex of  $P'_n$  and  $1 \leq j \leq s-1$ , the proof is divided into cases following:

**Case 1.** If  $r$  and  $s$  are both even, the neighborhood vertices of each vertex  $v_j$  are either  $(\frac{n-1+r}{2} + j, \frac{n-1+r}{2} + j + 1)$  or  $(\frac{r}{2} + j, \frac{r}{2} + j + 1)$ . These are consecutive integers. So the gcd of the neighborhood vertices of  $v_j$  is 1.

**Case 2.** If  $r$  is even but  $s$  is odd, the neighborhood vertices of each vertex  $v_j$  are either  $(\frac{n+r}{2} + j, \frac{n+r}{2} + j + 1)$  or  $(\frac{r}{2} + j, \frac{r}{2} + j + 1)$ . These are consecutive integers. So the gcd of the neighborhood vertices of  $v_j$  is 1.

**Case 3.** If  $r$  is odd but  $s$  is even, the neighborhood vertices of each vertex  $v_j$  are either  $(\frac{n-1+r}{2} + j, \frac{n-1+r}{2} + j + 1)$  or  $(\frac{r-1}{2} + j, \frac{r-1}{2} + j + 1)$ . These are consecutive integers. So the gcd of the neighborhood vertices of  $v_j$  is 1.

**Case 4.** If  $r$  and  $s$  are both odd the neighborhood vertices of each vertex  $v_j$  are either  $(\frac{n+r}{2} + j, \frac{n+r}{2} + j + 1)$  or  $(\frac{r-1}{2} + j, \frac{r-1}{2} + j + 1)$ . These are consecutive integers. So the gcd of the neighborhood vertices of  $v_j$  is 1.

(2) If  $u_i$  is a vertex of  $C'_n$ ,  $2 \leq i \leq r$ , the proof is divided into cases following:

**Case 1.** If  $r$  and  $s$  are both even, the neighborhood vertices of each vertex  $u_i$  are either  $(\frac{n-1}{2} + i, \frac{n-1}{2} + i + 1)$  or  $(i, i + 1)$ . These are consecutive integers. So the gcd of the neighborhood vertices of  $u_i$  is 1.

**Case 2.** If  $r$  is even but  $s$  is odd, the neighborhood vertices of each vertex  $u_i$  are either  $(\frac{n-2}{2} + i, \frac{n-2}{2} + i + 1)$  or  $(i, i + 1)$ . These are consecutive integers. So the gcd of the neighborhood vertices of  $u_i$  is 1.



**Case 3.** If  $r$  is odd but  $s$  is even, the neighborhood vertices of each vertex  $u_i$  are either  $(\frac{n-2}{2}+i, \frac{n-2}{2}+i+1)$  or  $(i, i+1)$ . These are consecutive integers. So the gcd of the neighborhood vertices of  $u_i$  is 1.

**Case 4.** If  $r$  and  $s$  are both odd, the neighborhood vertices of each vertex  $u_i$  are either  $(\frac{n-1}{2}+i, \frac{n-1}{2}+i+1)$  or  $(i, i+1)$ . These are consecutive integers. So the gcd of the neighborhood vertices of  $u_i$  is 1.

(3) For the vertex  $u = u_1$  in  $C'_n$ , the labeling of one of the neighborhood vertex is one. So the gcd is one.

Finally if we identifying the vertices  $v_1$  and  $v_n$  of the path  $P_n$ , then the graph  $G$  is a cycle with  $n - 1$  vertices. The cycle  $C_n$  is neighborhood prime for  $n \not\equiv 2(mod4)$ ,  $G$  is neighborhood prime if  $n \not\equiv 3(mod4)$ .  $\square$

### §3. Neighborhood Prime Labeling on Cycle Related Graphs

In this section we consider neighborhood prime labeling on cycle with chords, cycle with switching a vertex, path union of cycles and join of two cycles with a path. In [10] Mathew Varkey T.K and Sunoj B.S proved that, every cycle  $C_n$  with a chord is prime for  $n \geq 4$  and every cycle  $C_n$  with  $[\frac{n-1}{2}] - 1$  chords from a vertex is prime for  $n \geq 5$ . We have the following theorems.

**Theorem 3.1** *Every cycle  $C_n$  with a chord is neighborhood prime for all  $n \geq 4$ .*

*Proof* Let  $G$  be a graph such that  $G = C_n$  with a chord joining two non-adjacent vertices of  $C_n$ , for all  $n \geq 4$ . Let  $\{v_1, v_2, \dots, v_n\}$  be the vertex set of  $G$ . Let the number of vertices of  $G$  be  $n$  and number of edges of  $G$  be  $n + 1$ .

(1) If  $n \not\equiv 2(mod4)$ , define a function  $f : V(G) \rightarrow \{1, 2, \dots, n\}$  as follows:

**Case 1.** If  $n$  is odd, let

$$f(v_{2j-1}) = \frac{n-1}{2} + j, 1 \leq j \leq \frac{n+1}{2} \text{ and } f(v_{2j}) = j, 1 \leq j \leq \frac{n-1}{2}.$$

**Case 2.** If  $n$  is even, let

$$f(v_{2j-1}) = \frac{n}{2} + j, 1 \leq j \leq \frac{n}{2} \text{ and } f(v_{2j}) = j, 1 \leq j \leq \frac{n}{2}.$$

The neighborhood vertices of each vertex  $v_i$  except  $v_n$  is  $\{v_{i-1}, v_{i+1}\}$  and they are consecutive integers, so it is neighborhood prime. The neighborhood vertices of  $v_n$  is  $\{v_{n-1}, v_1\}$  and the corresponding labels are consecutive integers  $\frac{n-1}{2}$  and  $\frac{n+1}{2}$  if  $n$  is odd,  $n$  and  $\frac{n}{2} + 1$  if  $n$  is even. Now select the vertex  $v_i$  and join this to any vertex of  $G$  which is not adjacent to  $v_i$ . Then it is clear that the gcd of labeling of the neighborhood vertices of each vertex is one and  $G$  is neighborhood prime graph.

(2) If  $n \equiv 2(mod4)$ , the labeling of the same function shows that there exists at least one vertex whose neighborhood set is not prime. Let  $v_i$  be the vertex whose neighborhood set is not

prime. We choose the vertex  $v_j$  which is not adjacent and relatively prime to  $v_i$  in  $G$  and join with a chord. Then  $G$  is a neighborhood prime graph.  $\square$

**Theorem 3.2** *Every cycle  $C_n$  with  $n-3$  chords from a vertex is neighborhood prime for  $n \geq 5$ .*

*Proof* Let  $G$  be a graph such that  $G = C_n, n \geq 5$ . Let  $\{v_1, v_2, \dots, v_n\}$  be the vertex set of  $G$ . Choose an arbitrary vertex  $v_i$  and joining  $v_i$  to all the vertices which are not adjacent to  $v_i$ . Then there are  $n-3$  chords to  $v_i$  and from the above theorem  $G$  admits neighborhood prime labeling.  $\square$

**Theorem 3.3** *The graph obtained by switching of any vertex in a cycle  $C_n$  is neighborhood prime graph.*

*Proof* Let  $G = C_n$  and  $v_1, v_2, \dots, v_n$  be the successive vertices of  $C_n$ . Let  $G_{v_k}$  denotes the vertex switching of  $G$  with respect to the vertex  $v_k$ . Here  $|V(G_{v_k})| = n$  and  $|E(G_{v_k})| = 2n - 5$ . Define a labeling  $f : V(G) \rightarrow \{1, 2, 3, \dots, n\}$  as follows:

$$\begin{aligned} f(v_k) &= 1, \\ f(v_i) &= i + 1, 1 \leq i \leq k - 1, \\ f(v_{k+i}) &= f(v_{k-1}) + i, 1 \leq i \leq n - k. \end{aligned}$$

Then for any vertex  $v_i$  other than  $v_k$ , the neighborhood vertices containing  $v_k$  and so the gcd of the label of vertices in  $N(v_i)$  is 1.  $G_{v_k}$  is a neighborhood prime graph.  $\square$

**Theorem 3.4** *Let  $G$  be the graph obtained by the path union of finite number of copies of cycle  $C_n$ .  $G$  is a neighborhood prime graph if  $n \not\equiv 2 \pmod{4}$ .*

*Proof* Let  $G$  be the path union of cycle  $C_n$  and  $G_1, G_2, \dots, G_k$  be  $k$  copies of cycle  $C_n$ . The vertices of  $G$  is  $nk$  and edges of  $G$  is  $(n + 1)k$ . Let us denote the vertices of  $G$  be  $v_{ij}, 1 \leq i \leq n, 1 \leq j \leq k$  and the successive vertices of the graph  $G_r$  by  $v_{1r}, v_{2r}, \dots, v_{nr}$ . Let  $e = v_{1r}v_{(r+1)}$  be the edge joining  $G_r$  and  $G_{(r+1)}$  for  $r = 1, 2, \dots, k - 1$ .

Define the labeling  $f : V(G) \rightarrow \{1, 2, \dots, nk\}$  as follows:

**Case 1.** If  $n$  is odd and  $1 \leq j \leq k$ , define

$$f(v_{(2i-1)j}) = nj + i - \frac{n+1}{2}, 1 \leq i \leq \frac{n+1}{2} \text{ and } f(v_{(2i)j}) = n(j-1) + i, 1 \leq i \leq \frac{n-1}{2}.$$

**Case 2.** If  $n$  is even and  $1 \leq j \leq k$ , define

$$f(v_{(2i-1)j}) = nj + i - \frac{n}{2}, 1 \leq i \leq \frac{n}{2} \text{ and } f(v_{(2i)j}) = n(j-1) + i, 1 \leq i \leq \frac{n}{2}.$$

We claim that  $f$  is a neighborhood prime labeling. If  $v_{ir}$  is any vertex of  $G$  in the  $r^{th}$  copy of the cycle  $C_n$  different from  $v_{1r}$ , then  $N(v_{ir}) = \{v_{(i-1)r}, v_{(i+1)r}\}$ . Since  $f(v_{(i-1)r})$  and  $f(v_{(i+1)r})$  are consecutive integers, gcd of the labels of the vertices in  $N(v_{ir})$  is 1.

Notice that  $N(v_{11}) = \{v_{n1}, v_{21}\}$  and  $f(v_{21}) = 1$ , the gcd of the labels of vertices in  $N(v_{11})$  is 1. Now we consider vertices  $v_{1r}, 1 \leq r \leq k$ .

**Case 1.** If  $n$  is odd, the labels of vertices in  $N(v_{1r})$  are  $n(r - \frac{3}{2}) + \frac{1}{2}$ ,  $n(r + \frac{1}{2}) + \frac{1}{2}$ ,  $n(r - 1) + 1$  and  $nr$ . They are relatively prime.

**Case 2.** If  $n$  is even, the labels of vertices in  $N(v_{1r})$  are  $n(r - \frac{3}{2}) + \frac{1}{2}$ ,  $n(r + \frac{1}{2}) + \frac{1}{2}$ ,  $n(r - 1) + 2$  and  $n(r - \frac{1}{2})$ . They are relatively prime.

Finally we consider  $v_{1k}$ .

**Case 1.** If  $n$  is odd, the labels of vertices in  $N(v_{1k})$  are  $n(k - \frac{3}{2}) + \frac{1}{2}$ ,  $n(k - 1) + 1$  and  $nk$ . They are relatively prime.

**Case 2.** If  $n$  is even, the labels of vertices in  $N(v_{1k})$  are  $n(k - \frac{3}{2}) + \frac{1}{2}$ ,  $n(k - 1) + 1$  and  $n(k - \frac{1}{2})$ . They are relatively prime.

The cycle  $C_n$  is not neighborhood prime if  $n \cong 2(mod 4)$ . Thus  $G$  is not neighborhood prime if  $n \cong 2(mod 4)$ . Hence  $G$  is neighborhood prime if  $n \not\cong 2(mod 4)$ .  $\square$

**Theorem 3.5** *The graph obtained by joining two copies of cycle  $C_n$  by a path  $P_k$  is a neighborhood prime graph if  $n \not\cong 2(mod 4)$ .*

*Proof* Let  $G$  be the graph obtained by joining two copies of cycle  $C_n$  by a path  $P_k$ . The vertices of  $G$  are  $2n + k - 2$  and edges of  $G$  are  $2n + k - 1$ . Let  $v_1, v_2, \dots, v_n$  be the vertices of the first copy of cycle  $C_n$  and  $w_1, w_2, \dots, w_n$  be the vertices of the second copy of cycle  $C_n$ . Let  $u_1, u_2, \dots, u_k$  be the vertices of path  $P_k$  with  $v_1 = u_1$  and  $w_1 = u_k$ .

Define the labeling  $f : V(G) \rightarrow \{1, 2, 3, \dots, 2n + k - 2\}$  as follows:

**Case 1.** If  $n$  is odd, let the labeling on  $C_n$  be

$$f(v_{2i-1}) = \frac{n-1}{2} + i, 1 \leq i \leq \frac{n+1}{2}, \quad f(v_{2i}) = i, 1 \leq i \leq \frac{n-1}{2}$$

and

$$f(w_{2i-1}) = \frac{3n-1}{2} + i, 1 \leq i \leq \frac{n+1}{2}, \quad f(w_{2i}) = n + i, 1 \leq i \leq \frac{n-1}{2}.$$

**Case 2.** If  $n$  is even, let the labeling on  $C_n$  be

$$f(v_{2i-1}) = \frac{n}{2} + i, 1 \leq i \leq \frac{n}{2}, \quad f(v_{2i}) = i, 1 \leq i \leq \frac{n}{2}$$

and

$$f(w_{2i-1}) = \frac{3n}{2} + i, 1 \leq i \leq \frac{n}{2}, \quad f(w_{2i}) = n + i, 1 \leq i \leq \frac{n}{2}.$$

The labeling on  $P_k$  is defined by

**Case 1.** If  $k$  is odd, let

$$f(u_{2i}) = 2n + \frac{k-3}{2} + i, 1 \leq i \leq \frac{k-1}{2} \quad \text{and} \quad f(u_{2i+1}) = 2n + i, 1 \leq i \leq \frac{k-3}{2}.$$

**Case 2.** If  $k$  is even, let

$$f(u_{2i}) = 2n + \frac{k-2}{2} + i, 1 \leq i \leq \frac{k-2}{2} \quad \text{and} \quad f(u_{2i+1}) = 2n + i, 1 \leq i \leq \frac{k-2}{2}.$$

We claim that  $f$  is a neighborhood prime labeling. If  $v_i$  is any vertex of  $G$  in the first copy of the cycle  $C_n$  different from  $v_1$ , then  $N(v_i) = [v_{i-1}, v_{i+1}]$ . Since  $f(v_{i-1})$  and  $f(v_{i+1})$  are consecutive integers, the gcd of the label of the vertices is 1. Also  $N(v_1)$  contains the vertex  $v_2$  and  $f(v_2) = 1$ , the gcd of the label of vertices in  $N(v_1)$  is 1.

If  $w_i$  is any vertex of  $G$  in the second copy of the cycle  $C_n$  different from  $w_1$ , then  $N(w_i) = [w_{i-1}, w_{i+1}]$ . Since  $f(w_{i-1})$  and  $f(w_{i+1})$  are consecutive integers, the gcd of the label of the vertices is 1.

Now, consider  $w_1$ .

**Case 1.** If  $n$  is odd,  $N(w_1)$  are  $\{w_2, w_n, u_{k-1}\}$ . They are relatively prime for  $n \geq 1$  since  $f(w_2) = n + 1, f(w_n) = 2n$ .

**Case 2.** If  $n$  is even,  $N(w_1)$  are  $\{w_2, w_n, u_{k-1}\}$ . They are relatively prime for  $n \geq 2$  since  $f(w_2) = n + 1, f(w_n) = \frac{3n}{2}$ .

Finally, if  $u_i$  is any vertex of  $G$  in the path  $P_k$  different from  $u_i$  and  $u_k$ , then  $N(u_i) = \{u_{i-1}, u_{i+1}\}$ . Since  $f(u_{i-1})$  and  $f(u_{i+1})$  are consecutive integers, the gcd of the label of vertices of  $N(u_i)$  is 1. Thus,  $G$  is a neighborhood prime labeling graph if  $n \not\equiv 2 \pmod{4}$ .  $\square$

## References

- [1] G.S.Bloom, S.W.Golomb, *Pro.of the IEEE*, 165(4), (1977), 562-70.
- [2] F.Harary, *Graph Theory*, Addison Wesley, Reading, M.A, 1969.
- [3] Joseph A.Gallian, A dynamic survey of graph labeling, *The Electronic Journal of Combinatorics*, 17(2014).
- [4] Tout A.,Dabboucy A.N, Howalla K, Prime labeling of graphs, *Nat.Acad.Sci.Letters*, 11(1982),365-368.
- [5] Fu H.L, Huang K.C, On Prime labeling, *Discrete Math.*, 127(1994), 181-186.
- [6] Samir K.Vaidya, Udayan M.Prajapati, Some new results on prime graphs, *Open journal of Discrete Mathematics*, 2(2012), 99-104.
- [7] S.K.Vaidya, K.K.Kanani,Prime labeling for some cycle related graphs, *Journal of Mathematics Research*, Vol.2, No.2, May 2010.
- [8] S.K.Patel, N.P.Shrimali,Neighborhood prime labeling, *International journal of Mathematics and Soft Computing*, Vol.5, No.2(2015),135-143.
- [9] T.K.Mathew Varkey, *Some Graph Theoretic Operations Associated with Graph Labeling*, PhD thesis, University of Kerala, 2000.
- [10] T.K.Mathew Varkey, B.S.sunoj, A note on prime and sequential labelings of finite graphs, *International J.Maths.Combin.*, Vol.1(2015), 80-85.

## Papers Published in IJMC, 2016

### Vol.1,2016

1. $N^*C^*$ Smarandache Curve of Bertrand Curves Pair According to Frenet Frame Süleyman Şenyurt , Abdussamet Çalışkan, Ünzile Çelik .....	01
2. On Dual Curves of Constant Breadth According to Dual Bishop Frame in Dual Lorentzian Space $\mathbb{D}_1^3$ Süha Yılmaz, Yasin Ünlütürk, Ümit Ziya Savcı .....	08
3. On $(r, m, k)$ -Regular Fuzzy Graphs N.R.Santhimahaswari, C.Sekar .....	18
4. Super Edge-Antimagic Labeling of Subdivided Star Trees A.Raheem, A.Q.Baig .....	27
5. Surface Family with a Common Natural Geodesic Lift Evren Ergün, Ergin Bayram .....	34
6. Some Curvature Properties of LP-Sasakian Manifold with Respect to Quarter-Symmetric Metric Connection Santu Dey, Arindam Bhattacharyya .....	42
7. On Net-Regular Signed Graphs Nutan G.Nayak .....	57
8. On Common Fixed Point Theorems With Rational Expressions in Cone b-Metric Spaces G.S.Saluja .....	65
9. Binding Number of Some Special Classes of Trees	
10. B.Chaluvaraju, H.S.Boregowda, S.Kumbinarsaiah .....	76
11. On the Wiener Index of Quasi-Total Graph and Its Complement B.Basavanagoud, Veena R.Desai .....	82
12. Clique Partition of Transformation Graphs Chandrakala S.B, K.Manjula .....	91
13. Probabilistic Bounds On Weak and Strong Total Domination in Graphs M.H.Akhbari .....	97
14. Quotient Cordial Labeling of Graphs R.Ponraj, M.Maria Adaickalam, R.Kala .....	101
15. Nonholonomic Frames for Finsler Space with $(\alpha, \beta)$ -Metrics Brijesh Kumar Tripathi, K.B.Pandey, R.B. Tiwari .....	109
16. On $b$ -Chromatic Number of Some Line, Middle and Total Graph Families Vernold Vivin.J., Venkatachalam M., Mohanapriya N. ....	116
17. A Note on the Strong Defining Numbers in Graphs Z.Tahmasbzadehbaee, H.Abdollahzadeh Ahangar, D.A.Mojdeh .....	126
18. A Report on the Promoter Dr.Linfan Mao of Mathematical Combinatorics F.Smarandache .....	130

**Vol.2,2016**

1. Smarandache Curves and Applications According to Type-2 Bishop Frame in Euclidean 3-Space Süha Yılmaz and Ümit Ziya Savcı.....	01
2. Ruled Surface Pair Generated by Darboux Vectors of a Curve and Its Natural Lift in $\mathbb{R}_1^3$ Evren ERGÜN and Mustafa ÇALIŞKAN .....	16
3. Tutte Polynomial of Generalized Flower Graphs Nithya Sai Narayana.....	29
4. Entire Equitable Dominating Graph B.Basavanagoud, V.R.Kulli and Vijay V. Teli .....	43
5. Radio Mean Number of Certain Graphs R.Ponraj and S.S.Narayanan.....	51
6. Some Results on Vertex Version and Edge Versions of Modified Schultz Index Mahdieh Azari.....	65
7. Folding of Cayley Graphs M.R.Zeen El-Deen.....	83
8. The Merrifield-Simmons Indices of Triangle-Trees with $k$ Pendant-Triangles Xuezheng Lv, Zixu Yan and Erling Wei.....	92
9. On Linear Codes Over a Non-Chain Ring Abdullah Dertli, Yasemin Cengellenmis, Senol Eren.....	101
10. Nonsplit Geodetic Number of a Graph Tejaswini K M, Venkanagouda M Goudar and Venkatesh .....	109
11. $k$ -Difference cordial labeling of graphs R.Ponraj, M.Maria Adaickalam and R.Kala .....	121
12. Traversability and Covering Invariants of Token Graphs Keerthi G. Mirajkar and Priyanka Y. B .....	132
13. Different Labelings on Parallel Transformations of a Class of Trees Teena Liza John and Mathew Varkey T.K.....	139
14. Cycle and Armed Cap Cordial Graphs A.Nellai Murugan and P.Iyadurai Selvaraj .....	144
15. Traffic Congestion – A Challenging Problem in the World Mushtaq Ahmad Shah, Mridula Purohit and M.H.Gulzar .....	144

**Vol.3,2016**

1. Spacelike Smarandache Curves of Timelike Curves in Anti de Sitter 3-Space Mahmut Mak and Hasan Altınbaş .....	01
2. Conformal Ricci Soliton in Almost $C(\lambda)$ Manifold Tamalika Dutta, Arindam Bhattacharyya and Srabani Debnath.....	17
3. Labeled Graph – A Mathematical Element Linfan MAO.....	27

4. Tchebychev and Brahmagupta Polynomials and Golden Ratio–Two New Interconnections Shashikala P. and R. Rangarajan .....	57
5. On the Quaternionic Normal Curves in the Semi-Euclidean Space $E_2^4$ Önder Gökmen Yildiz and Siddika Özkaldi Karakuş .....	68
6. Global Equitable Domination Number of Some Wheel Related Graphs S.K.Vaidya and R.M.Pandit .....	77
7. The Pebbling Number of Jahangir Graph $J_{2,m}$ A.Lourdusamy and T.Mathivanan .....	86
8. On 4-Total Product Cordiality of Some Corona Graphs M.Sivakumar .....	99
9. On $m$ -Neighbourly Irregular Intuitionistic Fuzzy Graphs N.R.Santhi Maheswari and C.Sekar .....	107
10. Star Edge Coloring of Corona Product of Path with Some Graphs Kaliraj K., Sivakami R. and Vernold Vivin J. ....	115
11. Balance Index Set of Caterpillar and Lobster Graphs Pradeep G.Bhat and Devadas Nayak C .....	123
12. Lagrange Space and Generalized Lagrange Space Arising From Metric M.N.Tripathi and O.P.Pandey .....	136
13. A Study on Hamiltonian Property of Cayley Graphs Over Non-Abelian Groups A.Riyas and K.Geetha .....	141
14. Mean Cordial Labelling of Some Star-Related Graphs Ujwala Deshmukh and Vahida Y. Shaikh .....	146
15. Some New Families of Odd Graceful Graphs Mathew Varkey T.K and Sunoj. B.S .....	158

#### Vol.4,2016

1. Isotropic Smarandache Curves in Complex Space $C^3$ Süha Yılmaz .....	01
2. 2-Pseudo Neighbourly Irregular Intuitionistic Fuzzy Graphs S.Ravi Narayanan and S.Murugesan .....	08
3. A Generalization of the Alexander Polynomial İsmet Altıntaş and Kemal Taşköprü .....	21
4. Smarandache Curves of a Spacelike Curve According to the Bishop Frame of Type-2 Yasin Ünlütürk and Süha Yılmaz .....	29
5. Characterization of Locally Dually Flat Special Finsler $(\alpha, \beta)$ - Metrics Brijesh Kumar Tripathi and K.B. Pandey .....	44
6. Gröbner-Shirshov Bases Theory for the Right Ideals of Left-Commutative Algebras Yu Li .....	53
7. On the Riemann and Ricci Curvature of Finsler Spaces with Special $(\alpha, \beta)$ -Metric Gauree Shanker and Sruthy Asha Baby .....	61
8. The Nonsplit Roman Domination in Graphs	

C.Sivagnanam .....	70
9. A Study on Cayley Graphs of Non-Abelian Groups	
A.Riyas, K.Geetha.....	79
10. On Linear Operators Preserving Orthogonality of Matrices over Fuzzy Semirings	
Yizhi Chen and Jing Tian .....	88
11. On Wiener and Weighted Wiener Indices of Neighborhood Corona of Two Graphs	
Chandrashekar Adiga, Rakshith B. R., Sumithra and N. Anitha .....	97
12. Projective Dimension and Betti Number of Some Graphs	
A. Alilo, J. Amjadi, N. Vaez Moosavi and S. Mohammadikhah .....	109
13. k-Metric Dimension of a Graph	
B.Sooryanarayana1, S.Kunikullaya and N.N.Swamy .....	118
14. Radial Signed Graphs	
P.Siva Kota Reddy .....	128
15. The Geodesic Irredundant Sets in Graphs	
S.V.Ullas Chandran and G.Jaya Parthasarathy .....	135
16. Directed Pathos Block Line Cut-Vertex Digraph of an Arborescence	
H. M. Nagesh, R. Chandrasekhar and M. C. Mahesh Kumar .....	144
17. Spherical Chains Inside a Spherical Segment	
Buddhadev Pal, Santu Dey and Arindam Bhattacharyya .....	153
18. A Note on Neighborhood Prime Labeling	
Mathew Varkey T.K and Rajesh Kumar T.J .....	161



*We know nothing of what will happen in future, but by the analogy of past experience.*

By Abraham Lincoln, an American President.

## Author Information

**Submission:** Papers only in electronic form are considered for possible publication. Papers prepared in formats, viz., .tex, .dvi, .pdf, or.ps may be submitted electronically to one member of the Editorial Board for consideration in the **International Journal of Mathematical Combinatorics** (*ISSN 1937-1055*). An effort is made to publish a paper duly recommended by a referee within a period of 3 months. Articles received are immediately put the referees/members of the Editorial Board for their opinion who generally pass on the same in six week's time or less. In case of clear recommendation for publication, the paper is accommodated in an issue to appear next. Each submitted paper is not returned, hence we advise the authors to keep a copy of their submitted papers for further processing.

**Abstract:** Authors are requested to provide an abstract of not more than 250 words, latest Mathematics Subject Classification of the American Mathematical Society, Keywords and phrases. Statements of Lemmas, Propositions and Theorems should be set in italics and references should be arranged in alphabetical order by the surname of the first author in the following style:

## Books

[4]Linfan Mao, *Combinatorial Geometry with Applications to Field Theory*, InfoQuest Press, 2009.

[12]W.S.Massey, *Algebraic topology: an introduction*, Springer-Verlag, New York 1977.

## Research papers

[6]Linfan Mao, Mathematics on non-mathematics - A combinatorial contribution, *International J.Math. Combin.*, Vol.3(2014), 1-34.

[9]Kavita Srivastava, On singular H-closed extensions, *Proc. Amer. Math. Soc.* (to appear).

**Figures:** Figures should be drawn by TEXCAD in text directly, or as EPS file. In addition, all figures and tables should be numbered and the appropriate space reserved in the text, with the insertion point clearly indicated.

**Copyright:** It is assumed that the submitted manuscript has not been published and will not be simultaneously submitted or published elsewhere. By submitting a manuscript, the authors agree that the copyright for their articles is transferred to the publisher, if and when, the paper is accepted for publication. The publisher cannot take the responsibility of any loss of manuscript. Therefore, authors are requested to maintain a copy at their end.

**Proofs:** One set of galley proofs of a paper will be sent to the author submitting the paper, unless requested otherwise, without the original manuscript, for corrections after the paper is accepted for publication on the basis of the recommendation of referees. Corrections should be restricted to typesetting errors. Authors are advised to check their proofs very carefully before return.



### Contents

<b>Isotropic Smarandache Curves in Complex Space <math>C^3</math></b> By Süha Yılmaz .....	01
<b>2-Pseudo Neighbourly Irregular Intuitionistic Fuzzy Graphs</b> By S.Ravi Narayanan, S.Murugesan.....	08
<b>A Generalization of the Alexander Polynomial</b> By İsmet Altıntaş, Kemal Taşköprü .....	21
<b>Smarandache Curves of a Spacelike Curve According to the Bishop Frame of Type-2</b> By Yasin Ünlütürk, Süha Yılmaz .....	29
<b>Characterization of Locally Dually Flat Special Finsler <math>(\alpha, \beta)</math> - Metrics</b> By Brijesh Kumar Tripathi, K.B. Pandey.....	44
<b>Gröbner-Shirshov Bases Theory for the Right Ideals of Left-Commutative Algebras</b> By Yu Li.....	53
<b>On the Riemann and Ricci Curvature of Finsler Spaces with Special <math>(\alpha, \beta)</math>-Metric</b> By Gauree Shanker, Sruthy Asha Baby .....	61
<b>The Non-split Roman Domination in Graphs</b> By C.Sivagnanam.....	70
<b>A Study on Cayley Graphs of Non-Abelian Groups</b> By A.Riyas, K.Geetha.....	79
<b>On Linear Operators Preserving Orthogonality of Matrices over Fuzzy Semirings</b> By Yizhi Chen, Jing Tian .....	88
<b>On Wiener and Weighted Wiener Indices of Neighborhood Corona of Two Graphs</b> By Chandrashekar Adiga, Rakshith B. R., Sumithra, N. Anitha .....	97
<b>Projective Dimension and Betti Number of Some Graphs</b> By A. Alilo, J. Amjadi, N. Vaez Moosavi, S. Mohammadikhah .....	109
<b>k-Metric Dimension of a Graph</b> By B.Sooranarayana1, S.Kunikullaya, N.N.Swamy.....	118
<b>Radial Signed Graphs</b> By P.Siva Kota Reddy.....	128
<b>The Geodesic Irredundant Sets in Graphs</b> By S.V.Ullas Chandran, G.Jaya Parthasarathy .....	135
<b>Directed Pathos Block Line Cut-Vertex Digraph of an Arborescence</b> By H. M. Nagesh, R. Chandrasekhar, M. C. Mahesh Kumar .....	144
<b>Spherical Chains Inside a Spherical Segment</b> By Buddhadev Pal, Santu Dey, Arindam Bhattacharyya.....	153
<b>A Note on Neighborhood Prime Labeling</b> By Mathew Varkey T.K, Rajesh Kumar T.J ...	161

